

LVAC Power Capacitors



FEATURES

- Self-healing technology
- Over pressure tear-off fuse
- Aluminum case
- Excellent heat dissipation
- Various design options: slim diameter or low height, screw terminal IP00 or terminal block IP20
- Two versions available: oil-filled and dry, gas filled
- UL and cUL approved

APPLICATIONS

- For applications 1-phase or 3-phase $\leq 1000 \text{ VAC}_{\text{RMS}}$
- Free standing, fixed individual-PFC (e.g. motors, lighting, transformers)
- Automatic central-PFC (e.g. group of loads)
- Harmonic trap (e.g. UPS, frequency drives, converter)

QUICK REFERENCE DATA		
Series	PhMKP..., cylindrical	PhMKPg..., cylindrical
Description	LVAC Power Capacitors - Oil - INDOOR , IP00 - IP20	LVAC Power Capacitors - Dry - INDOOR , IP00 - IP20
Type	Capacitors, fixed, low voltage	Capacitors, fixed, low voltage
Technology	MKP, metallized polypropylene film	MKP, metallized polypropylene film
Voltage max. (V)	1000	1000
Capacitance min. (μF)	3-phase D: 3 x 11.5, 3-phase Y: 3 x 83.6, 1-phase: 49.7	3-phase D: 3 x 11.5, 3-phase Y: 3 x 83.6
Capacitance max. (μF)	3-phase D: 3 x 335.0, 3-phase Y: 3 x 219.3, 1-phase: 332.2	3-phase D: 3 x 335.0, 3-phase Y: 3 x 219.3
Output min. (kvar)	2	2
Output max. (kvar)	37.1	37.1



CAPACITORS IN CYLINDRICAL CASING

APPLICATION

The Vishay ESTA PhMKP / PhMKPg series of power factor correction capacitors in cylindrical aluminum casing now provide higher kvar/voltage combinations for use in low-voltage systems.

The newly available 116 mm and 136 mm diameter capacitors complete the successful range of compact and slim cylindrical capacitors of 64 mm and 84.4 mm diameter design up to the lowest outputs of the triangular can design of the PhMKDg model.

The 116 mm and 136 mm start where the output of the 84 mm design ends. At the point of change, the customer has two options: the lower height profile of the 116 mm and 136 mm or the slimmer diameter of the 84.4 mm design.

The Vishay ESTA LVAC capacitors are suitable for use in both standard PFC applications and in heavy-duty applications such as wind turbines:

- automatic PFC-equipment
- individual fixed PFC (e.g. motors, transformers, lighting)
- group fixed PFC
- tuned and detuned capacitor banks
- harmonic filters (e.g. UPS, frequency drives, converter)

DESIGN

The Vishay ESTA LVAC MKP capacitors are metallized polypropylene film capacitors with self-healing properties. The current carrying metal layer of an MKP capacitor is vaporised onto one side of the polypropylene film. The front surface of tubular winding elements are joined by means of the metal spray method (schooping). Three winding elements are encapsulated in one aluminum casing and connected to form a true 3-phase capacitor. The overpressure tear-off fuse prevents the capacitor from bursting at the end of service life, or due to inadmissible electrical or thermal overloads.

The capacitor is housed in a tubular aluminum container with a aluminum lid press-rolled onto it (64 mm and 84.4 mm) or welded (116 mm and 136 mm). The current is supplied via IP00 screw-on (M5) or IP20 block type safety terminal. A threaded stud (M12) at the bottom of the container serves for both grounding and mounting.

The Vishay ESTAprop and ESTAdry capacitors will be delivered together with discharge resistors and hardware for mounting and connection.

Vishay ESTA standard capacitors of 64 mm, 84.4 mm, 116 mm and 136 mm diameter will be delivered together with a thick film discharge resistor unit and fixing material for easy mounting and connection. In 84.4 mm diameter IP00 design there is also an option for feed-through (IN-LINE) connection of the capacitors to the supply.

The entire range of Vishay ESTA LVAC products are offered in both natural oil-filled ESTAprop PhMKP and gas-filled ESTAdry PhMKPg versions.

1-/3-PHASE CAPACITOR, IP00 SCREW-TYPE TERMINALS 84.4 mm DIAMETER



1-/3-PHASE CAPACITOR, IP20 TERMINAL BLOCK 64 mm / 84.4 mm DIAMETER



3-PHASE CAPACITOR, IP20 TERMINAL BLOCK 116 mm DIAMETER



3-PHASE CAPACITOR, IP20 TERMINAL BLOCK 136 mm DIAMETER





CAPACITORS IN CYLINDRICAL CASING

TECHNICAL DATA	
STANDARDS	IEC 60831-1 + 2, EN 60831- 1 + 2, UL 810 LATEST EDITIONS, UL / ULC - FILE E97723
Overvoltages (in accordance with the above standards)	U _{cn} + 10 % (up to 8 h daily) U _{cn} + 15 % (up to 30 min daily) U _{cn} + 20 % (up to 5 min, only 200 times in the life of the capacitor) U _{cn} + 30 % (up to 1 min, only 200 times in the life of the capacitor) Please also refer to "Terms and Definitions".
Overcurrent (in accordance with the above standards)	1.3 x I _n , 1.43 x I _n with 10 % overvoltages, 10 % over capacitance and harmonics included, continuous operation Please also refer to "Terms and Definitions".
Tolerance on capacitance	- 5 % / + 10 % in accordance with the standards ± 5 % as Vishay ESTA standard
Test voltage, terminal / terminal	2.15 x U _{cn} , VAC, 2 s (routine test)
Test voltage, terminal / casing	4800 VAC, 2 s (routine test)
Inrush current	300 times rated current I _n
Losses	≤ 0.25 W/kvar to 0.45 W/kvar (without discharge resistors)
Statistical life expectancy ⁽¹⁾	> 150 000 operating h (ESTAprop) > 130 000 operating h (ESTAdry)
Degree of protection	IP20 clamp terminal with mounted discharge resistor unit or IP00 (terminal cover for higher protection class upon request), indoor
Ambient temperature category	-25 / D (max. 55 °C) ESTAprop, -40 / D (max. 55 °C) ESTAdry
Permitted casing temperature	Max. 65 °C (measured on top of the can)
Cooling	Naturally air-cooled
Permissible relative humidity	Maximum 95 %
Maximum allowed altitude	2000 m above sea level
Mounting position	Vertical and horizontal
Mounting and grounding	Threaded M12 stud at the bottom of the container
Safety features	All-phase overpressure tear-off fuse, self-healing
Casing	Aluminum can
Dielectric	Polypropylene film, self-healing
Filling agent	Natural oil, non-PCB, biodegradable (ESTAprop) or dry / gas - filled (ESTAdry)
Terminals per casing Ø	Ø 64 mm IP20 M5 terminal block A (D-351), 2.0 Nm, max. 16 mm² Drawing 1 Max. current, depending on ambient conditions: 34 A (1-phase) / 25 A (3-phase)
	Ø 84 mm IP00 M5 screw terminals (D-203), 2.0 Nm, max. 25 mm² Drawing 2, feed through Max. current, depending on ambient conditions: 57 A (1-phase) / 52 A (3-phase) IP20 M5 terminal block A (D-351), 2.0 Nm, max. 16 mm² Drawing 3 Max. current, depending on ambient conditions: 57 A (1-phase) / 52 A (3-phase)
	Ø 116 mm IP20 M5 terminal block B (D-352), 2.0 Nm, max. 25 mm² Drawing 4 Max. current, depending on ambient conditions: 60 A (3-phase)
	Ø 136 mm IP20 M5 terminal block B (D-352), 2.0 Nm, max. 25 mm² Drawing 5 Max. current, depending on ambient conditions: 60 A (3-phase)

Note

- ⁽¹⁾ Statements about product lifetime are based on calculations and internal testing. They should only be interpreted as estimations. Also due to external factors, the lifetime in the field application may deviate from the calculated lifetime. In general, nothing stated herein shall be construed as a guarantee of quality or durability.



3-PHASE CAPACITORS

IP00, OIL

RATED VOLTAGE 230 V, 50 Hz, DELTA CONNECTION, UL / ULC							
TYPE	ARTICLE NO. ⁽¹⁾	OUTPUT kvar	CAP. μ F	CURRENT A	DIMENSIONS \varnothing x H mm	WEIGHT kg	DRAWING NO.
PhMKP230.3.10,00-84	5341-44400-xx	10	3 x 200.6	25.1	84.4 x 265	1.7	2
PhMKP230.3.12,50-84	5341-44401-xx	12.5	3 x 250.7	31.4	84.4 x 340	2.0	2
PhMKP230.3.15,00-84	5341-44402-xx	15	3 x 300.9	37.7	84.4 x 340	2.1	2

RATED VOLTAGE 400 V, 50 Hz, DELTA CONNECTION, UL / ULC								
CAN BE USED ALSO FOR 415 V, FULL OVER VOLTAGE RANGE								
TYPE	ARTICLE NO. ⁽¹⁾	OUTPUT kvar 400 V	OUTPUT kvar 415 V	CAP. μ F	CURRENT A 400 V / 415 V	DIMENSIONS \varnothing x H mm	WEIGHT kg	DRAWING NO.
PhMKP400.3.10,00-84	5341-44403-xx	10	10.8	3 x 66.3	14.4 / 15.0	84.4 x 190	1.3	2
PhMKP400.3.12,50-84	5341-44404-xx	12.5	13.5	3 x 82.9	18.0 / 18.7	84.4 x 190	1.3	2
PhMKP400.3.15,00-84	5341-44405-xx	15	16.1	3 x 99.5	21.6 / 22.4	84.4 x 190	1.3	2
PhMKP400.3.16,70-84	5341-44406-xx	16.7	18.0	3 x 110.7	24.1 / 25.0	84.4 x 265	1.7	2
PhMKP400.3.20,00-84	5341-44407-xx	20	21.5	3 x 132.6	28.8 / 30.0	84.4 x 265	1.7	2
PhMKP400.3.25,00-84	5341-44408-xx	25	26.9	3 x 165.8	36.1 / 37.4	84.4 x 265	1.7	2

RATED VOLTAGE 440 V, 50 Hz, DELTA CONNECTION, UL / ULC								
CAN BE USED ALSO FOR 415 V								
TYPE	ARTICLE NO. ⁽¹⁾	OUTPUT kvar 440 V	OUTPUT kvar 415 V	CAP. μ F	CURRENT A 440 V / 415 V	DIMENSIONS \varnothing x H mm	WEIGHT kg	DRAWING NO.
PhMKP440.3.12,50-84	5341-44409-xx	12.5	11.1	3 x 68.5	16.4/15.5	84.4 x 190	1.3	2
PhMKP440.3.14,10-84	5341-44410-xx	14.1	12.5	3 x 77.0	18.5/17.5	84.4 x 190	1.3	2
PhMKP440.3.15,00-84	5341-44411-xx	15	13.3	3 x 82.2	19.7/18.6	84.4 x 190	1.3	2
PhMKP440.3.16,90-84	5341-44412-xx	16.9	15	3 x 92.6	22.2/20.9	84.4 x 190	1.3	2
PhMKP440.3.18,80-84	5341-44413-xx	18.8	16.7	3 x 103.0	24.7/23.3	84.4 x 265	1.7	2
PhMKP440.3.20,00-84	5341-44414-xx	20	17.8	3 x 109.6	26.2/24.8	84.4 x 265	1.7	2
PhMKP440.3.22,50-84	5341-44415-xx	22.5	20	3 x 123.3	29.5/27.8	84.4 x 265	1.7	2
PhMKP440.3.25,00-84	5341-44416-xx	25	22.2	3 x 137.0	32.8/30.9	84.4 x 265	1.7	2
PhMKP440.3.28,10-84	5341-44417-xx	28.1	25	3 x 154.0	36.9/34.8	84.4 x 265	1.7	2
PhMKP440.3.30,00-84	5341-44418-xx	30	26.7	3 x 164.4	39.4/37.1	84.4 x 340	2.1	2

RATED VOLTAGE 525 V, 50 Hz, DELTA CONNECTION, UL / ULC								
CAN BE USED ALSO FOR 480 V								
TYPE	ARTICLE NO. ⁽¹⁾	OUTPUT kvar 525 V	OUTPUT kvar 480 V	CAP. μ F	CURRENT A 525 V / 480 V	DIMENSIONS \varnothing x H mm	WEIGHT kg	DRAWING NO.
PhMKP525.3.10,00-84	5341-44419-xx	10	8.33	3 x 38.5	11.0 / 10.1	84.4 x 190	1.3	2
PhMKP525.3.12,50-84	5341-44420-xx	12.5	10.4	3 x 48.1	13.7 / 12.6	84.4 x 190	1.3	2
PhMKP525.3.13,80-84	5341-44421-xx	13.8	11.5	3 x 53.1	15.2 / 13.8	84.4 x 190	1.3	2
PhMKP525.3.15,00-84	5341-44422-xx	15	12.5	3 x 57.7	16.5 / 15.0	84.4 x 190	1.3	2
PhMKP525.3.20,00-84	5341-44423-xx	20	16.7	3 x 77.0	22.0 / 20.1	84.4 x 265	1.7	2
PhMKP525.3.25,00-84	5341-44424-xx	25	20	3 x 96.2	27.5 / 25.1	84.4 x 265	1.7	2

Notes

- Other voltage ratings, outputs, and frequencies upon request. All PhMKP-type capacitors may be also be applied in 60 Hz networks, output and current will, however, be 20 % higher in these cases (i.e. additional thermal load and therefore, a lower class of temperature must be taken into account)

⁽¹⁾ Version no. xx may differ as it respects small changes, e.g. on the label

3-PHASE CAPACITORS

IP00, OIL

RATED VOLTAGE 660 V, 50 Hz, DELTA CONNECTION, UL / ULC UP TO 660 V								
CAN BE USED ALSO FOR 690 V, FULL OVER VOLTAGE RANGE								
TYPE	ARTICLE NO. ⁽¹⁾	OUTPUT kvar 660 V	OUTPUT kvar 690 V	CAP. μF	CURRENT A 660 V / 690 V	DIMENSIONS Ø x H mm	WEIGHT kg	DRAWING NO.
PhMKP660.3.08,33-84	5341-44425-xx	8.33	9.1	3 x 20.3	7.3 / 7.6	84.4 x 190	1.4	2
PhMKP660.3.10,00-84	5341-44426-xx	10	10.9	3 x 24.4	8.7 / 9.1	84.4 x 190	1.9	2
PhMKP660.3.12,50-84	5341-44427-xx	12.5	13.7	3 x 30.4	10.9 / 11.5	84.4 x 265	1.9	2
PhMKP660.3.15,00-84	5341-44428-xx	15	16.4	3 x 36.5	13.1 / 13.7	84.4 x 265	2.0	2
PhMKP660.3.16,70-84	5341-44429-xx	16.7	18.3	3 x 40.7	14.6 / 15.3	84.4 x 265	2.0	2
PhMKP660.3.20,00-84	5341-44430-xx	20	21.9	3 x 48.7	17.5 / 18.3	84.4 x 340	2.4	2
PhMKP660.3.22,90-84	5341-44431-xx	22.9	25.0	3 x 55.8	20.0 / 20.9	84.4 x 340	2.4	2

RATED VOLTAGE 690 V, 50 Hz, DELTA CONNECTION								
CAN BE USED ALSO FOR 660 V								
TYPE	ARTICLE NO. ⁽¹⁾	OUTPUT kvar 660 V	OUTPUT kvar 690 V	CAP. μF	CURRENT A 690 V / 660 V	DIMENSIONS Ø x H mm	WEIGHT kg	DRAWING NO.
PhMKP690.3.12,50-84	5341-44432-xx	11.4	12.5	3 x 27.9	10.5 / 10.0	84.4 x 265	1.9	2
PhMKP690.3.15,00-84	5341-44433-xx	13.7	15	3 x 33.4	12.6 / 12.0	84.4 x 265	1.9	2
PhMKP690.3.20,00-84	5341-44434-xx	18.3	20	3 x 44.6	16.7 / 16.0	84.4 x 340	2.4	2
PhMKP690.3.25,00-84	5341-44435-xx	22.9	25	3 x 55.7	20.9 / 20.0	84.4 x 340	2.4	2

Notes

- Other voltage ratings, outputs, and frequencies upon request. All PhMKP-type capacitors may be also be applied in 60 Hz networks, output and current will, however, be 20 % higher in these cases (i.e. additional thermal load and therefore, a lower class of temperature must be taken into account)
- ⁽¹⁾ Version no. xx may differ as it respects small changes, e.g. on the label

**Terminal cover (IP20), available for 84.4 mm diameter tubular can type capacitors.
(Cable gland not available for use with these covers)**

TYPE	ARTICLE NO.	CAPACITOR Ø IN mm
CAP84-88-IN-LINE	5341-COV-84-88IP20	84.4

Type CAP84-88-IN-LINE

- Protection class IP20
- Protective cover prevents unintentional touching of live terminals
- Proper ventilation is provided by use of additional holes in the protective cover's top
- Six slots located on the cover, three on each side, allow easy IN-LINE connection between two

TERMINAL COVER IP20: CAP84-IN-LINE

IN-LINE CONNECTION BETWEEN TWO CAPACITORS, IP20



3-PHASE CAPACITORS

IP20, OIL

RATED VOLTAGE 230 V, 50 Hz, DELTA CONNECTION, UL / ULC							
TYPE	ARTICLE NO. (1)	OUTPUT kvar	CAP. µF	CURRENT A	DIMENSIONS Ø x H mm	WEIGHT kg	DRAWING NO.
PhMKP230.3.02,50-A64	5341-48300-xx	2.5	3 x 50.1	6.3	64 x 190	0.8	1
PhMKP230.3.05,00-A64	5341-48301-xx	5	3 x 100.3	12.6	64 x 265	1.0	1
PhMKP230.3.10,00-A84	5341-48600-xx	10	3 x 200.6	25.1	84.4 x 265	1.7	3
PhMKP230.3.12,50-A84	5341-48601-xx	12.5	3 x 250.7	31.4	84.4 x 340	2.0	3
PhMKP230.3.15,00-A84	5341-48602-xx	15	3 x 300.9	37.7	84.4 x 340	2.1	3
PhMKP230.3.10,00-B116	5341-47003-xx	10	3 x 200.6	25.1	116 x 160	2.1	4
PhMKP230.3.12,50-B116	5341-47004-xx	12.5	3 x 250.7	31.4	116 x 190	2.5	4
PhMKP230.3.15,00-B116	5341-47005-xx	15	3 x 300.9	37.7	116 x 190	2.5	4
PhMKP230.3.16,70-B116	5341-47006-xx	16.7	3 x 335.0	41.9	116 x 230	3.1	4

RATED VOLTAGE 400 V, 50 Hz, DELTA CONNECTION, UL / ULC								
CAN BE USED ALSO FOR 415 V, FULL OVER VOLTAGE RANGE								
TYPE	ARTICLE NO. (1)	OUTPUT kvar 400 V	OUTPUT kvar 415 V	CAP. µF	CURRENT A 400 V / 415 V	DIMENSIONS Ø x H mm	WEIGHT kg	DRAWING NO.
PhMKP400.3.02,50-A64	5341-48302-xx	2.5	2.7	3 x 16.6	3.6 / 3.7	64 x 190	0.8	1
PhMKP400.3.05,00-A64	5341-48303-xx	5	5.4	3 x 33.2	7.2 / 7.5	64 x 190	0.8	1
PhMKP400.3.06,67-A64	5341-48304-xx	6.67	7.2	3 x 44.2	9.6 / 10.0	64 x 190	0.8	1
PhMKP400.3.07,50-A64	5341-48305-xx	7.5	8.1	3 x 49.7	10.8 / 11.2	64 x 190	0.8	1
PhMKP400.3.08,33-A64	5341-48306-xx	8.33	9.0	3 x 55.2	12 / 12.5	64 x 190	0.8	1
PhMKP400.3.10,00-A64	5341-48307-xx	10	10.8	3 x 66.3	14.4 / 14.9	64 x 265	1.0	1
PhMKP400.3.12,50-A64	5341-48308-xx	12.5	13.5	3 x 82.9	18 / 18.7	64 x 265	1.0	1
PhMKP400.3.10,00-A84	5341-48603-xx	10	10.8	3 x 66.3	14.4 / 14.9	84.4 x 190	1.3	3
PhMKP400.3.12,50-A84	5341-48604-xx	12.5	13.5	3 x 82.9	18 / 18.7	84.4 x 190	1.3	3
PhMKP400.3.15,00-A84	5341-48605-xx	15	16.1	3 x 99.5	21.6 / 22.4	84.4 x 190	1.3	3
PhMKP400.3.16,70-A84	5341-48606-xx	16.7	18.0	3 x 110.7	24.1 / 25.0	84.4 x 265	1.7	3
PhMKP400.3.20,00-A84	5341-48607-xx	20	21.5	3 x 132.6	28.8 / 30.0	84.4 x 265	1.7	3
PhMKP400.3.25,00-A84	5341-48608-xx	25	26.9	3 x 165.8	36.1 / 37.4	84.4 x 265	1.7	3
PhMKP400.3.16,70-B116	5341-47010-xx	16.7	18.0	3 x 110.7	24.1 / 25.0	116 x 160	2.1	4
PhMKP400.3.20,00-B116	5341-47011-xx	20	21.5	3 x 132.6	28.8 / 29.9	116 x 160	2.1	4
PhMKP400.3.25,00-B116	5341-47012-xx	25	26.9	3 x 165.8	36.1 / 37.4	116 x 190	2.5	4
PhMKP400.3.30,00-B136	5341-47601-xx	30	32.3	3 x 198.9	43.3 / 44.9	136 x 190	2.6	5

Notes

- Other voltage ratings, outputs, and frequencies upon request. All PhMKP-type capacitors may be also be applied in 60 Hz networks, output and current will, however, be 20 % higher in these cases (i.e. additional thermal load and therefore, a lower class of temperature must be taken into account)

(1) Version no. xx may differ as it respects small changes, e.g. on the label



3-PHASE CAPACITORS

IP20, OIL

RATED VOLTAGE 440 V, 50 Hz, DELTA CONNECTION, UL / ULC								
CAN BE USED ALSO FOR 415 V								
TYPE	ARTICLE NO. ⁽¹⁾	OUTPUT kvar 440 V	OUTPUT kvar 415 V	CAP. µF	CURRENT A 440 V / 415 V	DIMENSIONS Ø x H mm	WEIGHT kg	DRAWING NO.
PhMKP440.3.02,50-A64	5341-48322-xx	2.5	2.2	3 x 13.7	3.3 / 3.1	64 x 190	0.7	1
PhMKP440.3.05,00-A64	5341-48309-xx	5	4.4	3 x 27.4	6.6 / 6.1	64 x 190	0.8	1
PhMKP440.3.08,33-A64	5341-48310-xx	8.33	7.4	3 x 45.7	10.9 / 10.3	64 x 190	0.8	1
PhMKP440.3.10,00-A64	5341-48311-xx	10	8.9	3 x 54.8	13.1 / 12.4	64 x 265	1.0	1
PhMKP440.3.11,20-A64	5341-48312-xx	11.2	10	3 x 61.4	14.7 / 13.9	64 x 265	1.0	1
PhMKP440.3.12,50-A64	5341-48313-xx	12.5	11.1	3 x 68.5	16.4 / 15.4	64 x 265	1.0	1
PhMKP440.3.14,00-A64	5341-48314-xx	14	12.5	3 x 76.7	18.4 / 17.4	64 x 265	1.0	1
PhMKP440.3.12,50-A84	5341-48609-xx	12.5	11.1	3 x 68.5	16.4 / 15.5	84.4 x 190	1.3	3
PhMKP440.3.14,10-A84	5341-48610-xx	14.1	12.5	3 x 77.0	18.5 / 17.5	84.4 x 190	1.3	3
PhMKP440.3.15,00-A84	5341-48611-xx	15	13.3	3 x 82.2	19.7 / 18.6	84.4 x 190	1.3	3
PhMKP440.3.16,90-A84	5341-48612-xx	16.9	15	3 x 92.6	22.2 / 20.9	84.4 x 190	1.3	3
PhMKP440.3.18,80-A84	5341-48613-xx	18.8	16.67	3 x 103.0	24.7 / 23.3	84.4 x 265	1.7	3
PhMKP440.3.20,00-A84	5341-48614-xx	20	17.8	3 x 109.6	26.2 / 24.8	84.4 x 265	1.7	3
PhMKP440.3.22,50-A84	5341-48615-xx	22.5	20	3 x 123.3	29.5 / 27.8	84.4 x 265	1.7	3
PhMKP440.3.25,00-A84	5341-48616-xx	25	22.2	3 x 137.0	32.8 / 30.9	84.4 x 265	1.7	3
PhMKP440.3.28,10-A84	5341-48617-xx	28.1	25	3 x 154.0	36.9 / 34.8	84.4 x 265	1.7	3
PhMKP440.3.30,00-A84	5341-48618-xx	30	26.7	3 x 164.4	39.4 / 37.1	84.4 x 340	2.1	3
PhMKP440.3.14,10-B116	5341-47068-xx	14.1	12.5	3 x 77.0	18.5 / 17.5	116 x 160	1.5	4
PhMKP440.3.18,80-B116	5341-47015-xx	18.8	16.67	3 x 103.0	24.7 / 23.3	116 x 160	1.8	4
PhMKP440.3.20,00-B116	5341-47016-xx	20	17.8	3 x 109.6	26.2 / 24.8	116 x 160	1.8	4
PhMKP440.3.22,50-B116	5341-47017-xx	22.5	20	3 x 123.3	29.5 / 27.8	116 x 160	1.9	4
PhMKP440.3.25,00-B116	5341-47018-xx	25	22.2	3 x 137.0	32.8 / 30.9	116 x 190	2.0	4
PhMKP440.3.28,10-B116	5341-47020-xx	28.1	25	3 x 154.0	36.9 / 34.8	116 x 190	2.0	4
PhMKP440.3.30,00-B116	5341-47022-xx	30	26.7	3 x 164.4	39.4 / 37.1	116 x 190	2.2	4
PhMKP440.3.33,00-B136	5341-47602-xx	33	29.4	3 x 180.9	43.3 / 40.9	136 x 190	2.3	5

Notes

- Other voltage ratings, outputs, and frequencies upon request. All PhMKP-type capacitors may be also be applied in 60 Hz networks, output and current will, however, be 20 % higher in these cases (i.e. additional thermal load and therefore, a lower class of temperature must be taken into account)
- (1) Version no. xx may differ as it respects small changes, e.g. on the label



3-PHASE CAPACITORS

IP20, OIL

RATED VOLTAGE 525 V, 50 Hz, DELTA CONNECTION, UL / ULC								
CAN BE USED ALSO FOR 480 V								
TYPE	ARTICLE NO. ⁽¹⁾	OUTPUT kvar 525 V	OUTPUT kvar 480 V	CAP. µF	CURRENT A 525 V / 480 V	DIMENSIONS Ø x H mm	WEIGHT kg	DRAWING NO.
PhMKP525.3.03,00-A64	5341-48315-xx	3	2.5	3 x 11.5	3.3 / 3.0	64 x 190	0.8	1
PhMKP525.3.05,00-A64	5341-48316-xx	5	4.2	3 x 19.2	5.5 / 5.0	64 x 190	0.8	1
PhMKP525.3.08,33-A64	5341-48317-xx	8.33	7	3 x 32.1	9.2 / 8.4	64 x 190	0.8	1
PhMKP525.3.10,00-A64	5341-48318-xx	10	8.33	3 x 38.5	11.0 / 10.1	64 x 265	1.0	1
PhMKP525.3.10,00-A84	5341-48619-xx	10	8.33	3 x 38.5	11.0 / 10.1	84.4 x 190	1.3	3
PhMKP525.3.12,50-A84	5341-48620-xx	12.5	10.4	3 x 48.1	13.7 / 12.6	84.4 x 190	1.3	3
PhMKP525.3.13.80-A84	5341-48621-xx	13.8	11.5	3 x 53.1	15.2 / 13.8	84.4 x 190	1.3	3
PhMKP525.3.15,00-A84	5341-48622-xx	15	12.5	3 x 57.7	16.5 / 15.0	84.4 x 190	1.3	3
PhMKP525.3.20,00-A84	5341-48623-xx	20	16.7	3 x 77.0	22.0 / 20.1	84.4 x 265	1.7	3
PhMKP525.3.25,00-A84	5341-48624-xx	25	20.9	3 x 96.2	27.5 / 25.1	84.4 x 265	1.7	3
PhMKP525.3.20,00-B116	5341-47024-xx	20	16.7	3 x 77.0	22.0 / 20.1	116 x 160	1.8	4
PhMKP525.3.25,00-B116	5341-47025-xx	25	20.9	3 x 96.2	27.5 / 25.1	116 x 190	2.5	4
PhMKP525.3.30,00-B116	5341-47069-xx	30	25.1	3 x 115.4	33.0 / 30.2	116 x 230	2.6	4
PhMKP525.3.30,00-B136	5341-47603-xx	30	25.1	3 x 115.4	33.0 / 30.2	136 x 190	2.6	5
PhMKP525.3.35,90-B116	5341-47070-xx	35.9	30	3 x 138.2	39.5 / 36.1	116 x 265	2.8	4
PhMKP525.3.35,90-B136	5341-47600-xx	35.9	30	3 x 138.2	39.5 / 36.1	136 x 230	3.5	5
PhMKP525.3.37,10-B116	5341-47065-xx	37.1	31	3 x 142.8	40.8 / 37.3	116 x 265	2.8	4
PhMKP525.3.37,10-B136	5341-47604-xx	37.1	31	3 x 142.8	40.8 / 37.3	136 x 230	3.5	5

Notes

- Other voltage ratings, outputs, and frequencies upon request. All PhMKP-type capacitors may be also be applied in 60 Hz networks, output and current will, however, be 20 % higher in these cases (i.e. additional thermal load and therefore, a lower class of temperature must be taken into account)
- (1) Version no. xx may differ as it respects small changes, e.g. on the label



3-PHASE CAPACITORS

IP20, OIL**RATED VOLTAGE 660 V, 50 Hz, 64 / 84: DELTA CONNECTION, 116 / 136: STAR CONNECTION, UL / ULC UP TO 660 V**

CAN BE USED ALSO FOR 690 V

TYPE	ARTICLE NO. ⁽¹⁾	OUTPUT kvar 660 V	OUTPUT kvar 690 V	CAP. μ F	CURRENT A 660 V / 690 V	DIMENSIONS \varnothing x H mm	WEIGHT kg	DRAWING NO.
PhMKP660.3.05,00-A64	5341-48319-xx	5	5.5	3 x 12.2	4.4 / 4.6	64 x 190	0.8	1
PhMKP660.3.08,33-A64	5341-48320-xx	8.33	9.1	3 x 20.3	7.3 / 7.6	64 x 265	1.0	1
PhMKP660.3.08,33-A84	5341-48625-xx	8.33	9.1	3 x 20.3	7.3 / 7.6	84.4 x 190	1.3	3
PhMKP660.3.10,00-A84	5341-48626-xx	10	10.9	3 x 24.4	8.7 / 9.1	84.4 x 190	1.3	3
PhMKP660.3.12,50-A84	5341-48627-xx	12.5	13.7	3 x 30.4	10.9 / 11.4	84.4 x 265	1.7	3
PhMKP660.3.15,00-A84	5341-48628-xx	15	16.4	3 x 36.5	13.1 / 13.7	84.4 x 265	1.7	3
PhMKP660.3.16,70-A84	5341-48629-xx	16.7	18.3	3 x 40.7	14.6 / 15.3	84.4 x 265	1.7	3
PhMKP660.3.20,00-A84	5341-48630-xx	20	21.9	3 x 48.7	17.5 / 18.3	84.4 x 340	2.1	3
PhMKP660.3.22,90-A84	5341-48631-xx	22.9	25	3 x 55.8	20 / 20.9	84.4 x 340	2.1	3
PhMKP660.2.12,50-B116	5341-47057-xx	12.5	13.7	3 x 91.4	10.9 / 11.4	116 x 160	2.1	4
PhMKP660.2.15,00-B116	5341-47058-xx	15	16.4	3 x 109.6	13.1 / 13.7	116 x 160	2.1	4
PhMKP660.2.16,70-B116	5341-47059-xx	16.7	18.3	3 x 122.1	14.6 / 15.3	116 x 160	2.1	4
PhMKP660.2.20,00-B116	5341-47061-xx	20	21.9	3 x 146.2	17.5 / 18.3	116 x 190	2.3	4
PhMKP660.2.22,90-B116	5341-47062-xx	22.9	25	3 x 167.3	20 / 20.9	116 x 190	2.5	4
PhMKP660.2.25,00-B136	5341-47605-xx	25	27.3	3 x 182.7	21.9 / 22.9	136 x 190	2.6	5
PhMKP660.2.30,00-B136	5341-47606-xx	30	32.8	3 x 219.2	26.2 / 27.4	136 x 230	3.4	5

RATED VOLTAGE 690 V, 50 Hz, 64 / 84: DELTA CONNECTION, 116 / 136: STAR CONNECTION

CAN BE USED ALSO FOR 660 V

TYPE	ARTICLE NO. ⁽¹⁾	OUTPUT kvar 690 V	OUTPUT kvar 660 V	CAP. μ F	CURRENT A 690 V / 660 V	DIMENSIONS \varnothing x H mm	WEIGHT kg	DRAWING NO.
PhMKP690.3.10,00-A64	5341-48321-xx	10	9.1	3 x 22.3	8.4 / 8.0	64 x 265	1.1	1
PhMKP690.3.12,50-A84	5341-48632-xx	12.5	11.4	3 x 27.9	10.5 / 10.0	84.4 x 265	1.9	3
PhMKP690.3.15,00-A84	5341-48633-xx	15	13.7	3 x 33.4	12.5 / 12.0	84.4 x 265	1.9	3
PhMKP690.3.20,00-A84	5341-48634-xx	20	18.3	3 x 44.6	16.7 / 16.0	84.4 x 340	2.4	3
PhMKP690.3.25,00-A84	5341-48635-xx	25	22.9	3 x 55.7	20.9 / 20.0	84.4 x 340	2.4	3
PhMKP690.2.12,50-B116	5341-47071-xx	12.5	11.4	3 x 83.6	10.5 / 10.0	116 x 160	2.0	4
PhMKP690.2.15,00-B116	5341-47072-xx	15	13.7	3 x 100.3	12.5 / 12.0	116 x 160	2.2	4
PhMKP690.2.20,00-B116	5341-47073-xx	20	18.3	3 x 133.7	16.7 / 16.0	116 x 190	2.2	4
PhMKP690.2.25,00-B116	5341-47074-xx	25	22.9	3 x 167.3	20.9 / 20.0	116 x 190	2.5	4

Notes

- Other voltage ratings, outputs, and frequencies upon request. All PhMKP-type capacitors may be also be applied in 60 Hz networks, output and current will, however, be 20 % higher in these cases (i.e. additional thermal load and therefore, a lower class of temperature must be taken into account)

⁽¹⁾ Version no. xx may differ as it respects small changes, e.g. on the label



3-PHASE CAPACITORS

IP00, DRY

RATED VOLTAGE 230 V, 50 Hz, DELTA CONNECTION, UL / ULC							
TYPE	ARTICLE NO. ⁽¹⁾	OUTPUT kvar	CAP. μ F	CURRENT A	DIMENSIONS \varnothing x H mm	WEIGHT kg	DRAWING NO.
PhMKPg230.3.10,00-84	5343-44001-xx	10	3 x 200.6	25.1	84.4 x 265	1.4	2
PhMKPg230.3.12,50-84	5343-44002-xx	12.5	3 x 250.7	31.4	84.4 x 340	1.5	2
PhMKPg230.3.15,00-84	5343-44003-xx	15	3 x 300.9	37.7	84.4 x 340	1.7	2

RATED VOLTAGE 400 V, 50 Hz, DELTA CONNECTION, UL / ULC								
CAN BE USED ALSO FOR 415 V, FULL OVER VOLTAGE RANGE								
TYPE	ARTICLE NO. ⁽¹⁾	OUTPUT kvar 400 V	OUTPUT kvar 415 V	CAP. μ F	CURRENT A 400 V / 415 V	DIMENSIONS \varnothing x H mm	WEIGHT kg	DRAWING NO.
PhMKPg400.3.10,00-84	5343-44004-xx	10	10.8	3 x 66.3	14.4 / 15.0	84.4 x 190	0.9	2
PhMKPg400.3.12,50-84	5343-44005-xx	12.5	13.5	3 x 82.9	18.0 / 18.7	84.4 x 190	1.0	2
PhMKPg400.3.15,00-84	5343-44006-xx	15	16.1	3 x 99.5	21.6 / 22.4	84.4 x 190	1.1	2
PhMKPg400.3.16,70-84	5343-44007-xx	16.7	18.0	3 x 110.7	24.1 / 25.0	84.4 x 265	1.4	2
PhMKPg400.3.20,00-84	5343-44008-xx	20	21.5	3 x 132.6	28.8 / 30.0	84.4 x 265	1.4	2
PhMKPg400.3.25,00-84	5343-44009-xx	25	26.9	3 x 165.8	36.1 / 37.4	84.4 x 265	1.5	2

RATED VOLTAGE 440 V, 50 Hz, DELTA CONNECTION, UL / ULC								
CAN BE USED ALSO FOR 415 V								
TYPE	ARTICLE NO. ⁽¹⁾	OUTPUT kvar 440 V	OUTPUT kvar 415 V	CAP. μ F	CURRENT A 440 V / 415 V	DIMENSIONS \varnothing x H mm	WEIGHT kg	DRAWING NO.
PhMKPg440.3.12,50-84	5343-44010-xx	12.5	11.1	3 x 68.5	16.4 / 15.5	84.4 x 190	1.0	2
PhMKPg440.3.14,10-84	5343-44011-xx	14.1	12.5	3 x 77.0	18.5 / 17.5	84.4 x 190	1.1	2
PhMKPg440.3.15,00-84	5343-44012-xx	15	13.3	3 x 82.2	19.7 / 18.6	84.4 x 190	1.1	2
PhMKPg440.3.16,90-84	5343-44013-xx	16.9	15	3 x 92.6	22.2 / 20.9	84.4 x 190	1.2	2
PhMKPg440.3.18,80-84	5343-44014-xx	18.8	16.7	3 x 103.0	24.7 / 23.3	84.4 x 265	1.3	2
PhMKPg440.3.20,00-84	5343-44015-xx	20	17.8	3 x 109.6	26.2 / 24.8	84.4 x 265	1.4	2
PhMKPg440.3.22,50-84	5343-44016-xx	22.5	20	3 x 123.3	29.5 / 27.8	84.4 x 265	1.4	2
PhMKPg440.3.25,00-84	5343-44017-xx	25	22.2	3 x 137.0	32.8 / 30.9	84.4 x 265	1.5	2
PhMKPg440.3.28,10-84	5343-44018-xx	28.1	25	3 x 154.0	36.9 / 34.8	84.4 x 265	1.5	2
PhMKPg440.3.30,00-84	5343-44019-xx	30	26.7	3 x 164.4	39.4 / 37.1	84.4 x 340	1.8	2

RATED VOLTAGE 525 V, 50 Hz, DELTA CONNECTION, UL / ULC								
CAN BE USED ALSO FOR 480 V								
TYPE	ARTICLE NO. ⁽¹⁾	OUTPUT kvar 525 V	OUTPUT kvar 480 V	CAP. μ F	CURRENT A 525 V / 480 V	DIMENSIONS \varnothing x H mm	WEIGHT kg	DRAWING NO.
PhMKPg525.3.10,00-84	5343-44020-xx	10	8.33	3 x 38.5	11.0 / 10.1	84.4 x 190	0.8	2
PhMKPg525.3.12,50-84	5343-44021-xx	12.5	10.4	3 x 48.1	13.7 / 12.6	84.4 x 190	1.0	2
PhMKPg525.3.13,80-84	5343-44022-xx	13.8	11.5	3 x 53.1	15.2 / 13.8	84.4 x 190	1.0	2
PhMKPg525.3.15,00-84	5343-44023-xx	15	12.5	3 x 57.7	16.5 / 15.0	84.4 x 190	1.1	2
PhMKPg525.3.20,00-84	5343-44024-xx	20	16.7	3 x 77.0	22.0 / 20.1	84.4 x 265	1.3	2
PhMKPg525.3.25,00-84	5343-44025-xx	25	20	3 x 96.2	27.5 / 25.1	84.4 x 265	1.5	2

Notes

- Other voltage ratings, outputs, and frequencies upon request. All PhMKP-type capacitors may be also be applied in 60 Hz networks, output and current will, however, be 20 % higher in these cases (i.e. additional thermal load and therefore, a lower class of temperature must be taken into account)

⁽¹⁾ Version no. xx may differ as it respects small changes, e.g. on the label

3-PHASE CAPACITORS
IP00, DRY

RATED VOLTAGE 660 V, 50 Hz, DELTA CONNECTION, UL / ULC UP TO 660 V								
CAN BE USED ALSO FOR 690 V, FULL OVER VOLTAGE RANGE								
TYPE	ARTICLE NO. ⁽¹⁾	OUTPUT kvar 660 V	OUTPUT kvar 690 V	CAP. μ F	CURRENT A 660 V / 690 V	DIMENSIONS \varnothing x H mm	WEIGHT kg	DRAWING NO.
PhMKPg660.3.08,33-84	5343-44026-xx	8.33	9.1	3 x 20.3	7.3 / 7.6	84.4 x 190	0.9	2
PhMKPg660.3.10,00-84	5343-44027-xx	10	10.9	3 x 24.4	8.7 / 9.1	84.4 x 190	1.1	2
PhMKPg660.3.12,50-84	5343-44028-xx	12.5	13.7	3 x 30.4	10.9 / 11.5	84.4 x 265	1.2	2
PhMKPg660.3.15,00-84	5343-44029-xx	15	16.4	3 x 36.5	13.1 / 13.7	84.4 x 265	1.4	2
PhMKPg660.3.16,70-84	5343-44030-xx	16.7	18.3	3 x 40.7	14.6 / 15.3	84.4 x 265	1.5	2
PhMKPg660.3.20,00-84	5343-44031-xx	20	21.9	3 x 48.7	17.5 / 18.3	84.4 x 340	1.7	2
PhMKPg660.3.22,90-84	5343-44032-xx	22.9	25.0	3 x 55.8	20.0 / 20.9	84.4 x 340	1.9	2

RATED VOLTAGE 690 V, 50 Hz, DELTA CONNECTION								
CAN BE USED ALSO FOR 660 V								
TYPE	ARTICLE NO. ⁽¹⁾	OUTPUT kvar 660 V	OUTPUT kvar 690 V	CAP. μ F	CURRENT A 690 V / 660 V	DIMENSIONS \varnothing x H mm	WEIGHT kg	DRAWING NO.
PhMKPg690.3.12,50-84	5343-44033-xx	11.4	12.5	3 x 27.9	10.5 / 10.0	84.4 x 265	1.1	2
PhMKPg690.3.15,00-84	5343-44034-xx	13.7	15	3 x 33.4	12.6 / 12.0	84.4 x 265	1.3	2
PhMKPg690.3.20,00-84	5343-44035-xx	18.3	20	3 x 44.6	16.7 / 16.0	84.4 x 340	1.6	2
PhMKPg690.3.25,00-84	5343-44036-xx	22.9	25	3 x 55.7	20.9 / 20.0	84.4 x 340	1.9	2

Notes

- Other voltage ratings, outputs, and frequencies upon request. All PhMKP-type capacitors may be also be applied in 60 Hz networks, output and current will, however, be 20 % higher in these cases (i.e. additional thermal load and therefore, a lower class of temperature must be taken into account)
- ⁽¹⁾ Version no. xx may differ as it respects small changes, e.g. on the label

**Terminal cover (IP20), available for 84.4 mm diameter tubular can type capacitors.
(Cable gland not available for use with these covers)**

TYPE	ARTICLE NO.	CAPACITOR \varnothing IN mm
CAP84-88-IN-LINE	5341-COV-84-88IP20	84.4

Type CAP84-88-IN-LINE

- Protection class IP20
- Protective cover prevents unintentional touching of live terminals
- Proper ventilation is provided by use of additional holes in the protective cover's top
- Six slots located on the cover, three on each side, allow easy IN-LINE connection between two

TERMINAL COVER IP20: CAP84-IN-LINE

IN-LINE CONNECTION BETWEEN TWO CAPACITORS, IP20



3-PHASE CAPACITORS

IP20, DRY

RATED VOLTAGE 230 V, 50 Hz, DELTA CONNECTION, UL / ULC							
TYPE	ARTICLE NO. ⁽¹⁾	OUTPUT kvar	CAP. μ F	CURRENT A	DIMENSIONS \varnothing x H mm	WEIGHT kg	DRAWING NO.
PhMKPg230.3.02,50-A64	5343-48200-xx	2.5	3 x 50.1	6.3	64 x 190	0.6	1
PhMKPg230.3.05,00-A64	5343-48201-xx	5	3 x 100.3	12.6	64 x 265	0.8	1
PhMKPg230.3.10,00-A84	5343-48500-xx	10	3 x 200.6	25.1	84.4 x 265	1.4	3
PhMKPg230.3.12,50-A84	5343-48501-xx	12.5	3 x 250.7	31.4	84.4 x 340	1.5	3
PhMKPg230.3.15,00-A84	5343-48502-xx	15	3 x 300.9	37.7	84.4 x 340	1.7	3
PhMKPg230.3.10,00-B116	5343-47206-xx	10	3 x 200.6	25.1	116 x 160	1.5	4
PhMKPg230.3.12,50-B116	5343-47207-xx	12.5	3 x 250.7	31.4	116 x 190	1.7	4
PhMKPg230.3.15,00-B116	5343-47208-xx	15	3 x 300.9	37.7	116 x 190	1.9	4
PhMKPg230.3.16,70-B116	5343-47209-xx	16.7	3 x 335.0	41.9	116 x 230	2.2	4

RATED VOLTAGE 400 V, 50 Hz, DELTA CONNECTION, UL / ULC								
CAN BE USED ALSO FOR 415 V, FULL OVER VOLTAGE RANGE								
TYPE	ARTICLE NO. ⁽¹⁾	OUTPUT kvar 400 V	OUTPUT kvar 415 V	CAP. μ F	CURRENT A 400 V / 415 V	DIMENSIONS \varnothing x H mm	WEIGHT kg	DRAWING NO.
PhMKPg400.3.02,50-A64	5343-48202-xx	2.5	2.7	3 x 16.6	3.6 / 3.7	64 x 190	0.6	1
PhMKPg400.3.05,00-A64	5343-48203-xx	5	5.4	3 x 33.2	7.2 / 7.5	64 x 190	0.6	1
PhMKPg400.3.06,67-A64	5343-48204-xx	6.67	7.2	3 x 44.2	9.6 / 10.0	64 x 190	0.6	1
PhMKPg400.3.07,50-A64	5343-48205-xx	7.5	8.1	3 x 49.7	10.8 / 11.2	64 x 190	0.6	1
PhMKPg400.3.08,33-A64	5343-48206-xx	8.33	9.0	3 x 55.2	12 / 12.5	64 x 190	0.7	1
PhMKPg400.3.10,00-A64	5343-48207-xx	10	10.8	3 x 66.3	14.4 / 14.9	64 x 265	0.7	1
PhMKPg400.3.12,50-A64	5343-48208-xx	12.5	13.5	3 x 82.9	18 / 18.7	64 x 265	0.8	1
PhMKPg400.3.10,00-A84	5343-48503-xx	10	10.8	3 x 66.3	14.4 / 14.9	84.4 x 190	1.0	3
PhMKPg400.3.12,50-A84	5343-48504-xx	12.5	13.5	3 x 82.9	18 / 18.7	84.4 x 190	1.4	3
PhMKPg400.3.15,00-A84	5343-48505-xx	15	16.1	3 x 99.5	21.6 / 22.4	84.4 x 190	1.4	3
PhMKPg400.3.16,70-A84	5343-48506-xx	16.7	18.0	3 x 110.7	24.1 / 25.0	84.4 x 265	1.4	3
PhMKPg400.3.20,00-A84	5343-48507-xx	20	21.5	3 x 132.6	28.8 / 30.0	84.4 x 265	1.4	3
PhMKPg400.3.25,00-A84	5343-48508-xx	25	26.9	3 x 165.8	36.1 / 37.4	84.4 x 265	1.5	3
PhMKPg400.3.16,70-B116	5343-47212-xx	16.7	18.0	3 x 110.7	24.1 / 25.0	116 x 160	1.5	4
PhMKPg400.3.20,00-B116	5343-47213-xx	20	21.5	3 x 132.6	28.8 / 29.9	116 x 160	1.6	4
PhMKPg400.3.25,00-B116	5343-47215-xx	25	26.9	3 x 165.8	36.1 / 37.4	116 x 190	1.9	4
PhMKPg400.3.30,00-B136	5343-47500-xx	30	32.3	3 x 198.9	43.3 / 44.9	136 x 190	2.0	5

Notes

- Other voltage ratings, outputs, and frequencies upon request. All PhMKP-type capacitors may be also be applied in 60 Hz networks, output and current will, however, be 20 % higher in these cases (i.e. additional thermal load and therefore, a lower class of temperature must be taken into account)

⁽¹⁾ Version no. xx may differ as it respects small changes, e.g. on the label



3-PHASE CAPACITORS

IP20, DRY

RATED VOLTAGE 440 V, 50 Hz, DELTA CONNECTION, UL / ULC								
CAN BE USED ALSO FOR 415 V								
TYPE	ARTICLE NO. ⁽¹⁾	OUTPUT kvar 440 V	OUTPUT kvar 415 V	CAP. μ F	CURRENT A 440 V / 415 V	DIMENSIONS \varnothing x H mm	WEIGHT kg	DRAWING NO.
PhMKPg440.3.02,50-A64	5343-48222-xx	2.5	2.2	3 x 13.7	3.3 / 3.1	64 x 190	0.6	1
PhMKPg440.3.05,00-A64	5343-48209-xx	5	4.4	3 x 27.4	6.6 / 6.1	64 x 190	0.6	1
PhMKPg440.3.08,33-A64	5343-48210-xx	8.33	7.4	3 x 45.7	10.9 / 10.3	64 x 190	0.6	1
PhMKPg440.3.10,00-A64	5343-48211-xx	10	8.9	3 x 54.8	13.1 / 12.4	64 x 265	0.8	1
PhMKPg440.3.11,20-A64	5343-48212-xx	11.2	10	3 x 61.4	14.7 / 13.9	64 x 265	0.8	1
PhMKPg440.3.12,50-A64	5343-48213-xx	12.5	11.1	3 x 68.5	16.4 / 15.4	64 x 265	0.8	1
PhMKPg440.3.14,00-A64	5343-48214-xx	14	12.5	3 x 76.7	18.4 / 17.4	64 x 265	1.0	1
PhMKPg440.3.12,50-A84	5343-48509-xx	12.5	11.1	3 x 68.5	16.4 / 15.5	84.4 x 190	1.0	3
PhMKPg440.3.14,10-A84	5343-48510-xx	14.1	12.5	3 x 77.0	18.5 / 17.5	84.4 x 190	1.1	3
PhMKPg440.3.15,00-A84	5343-48511-xx	15	13.3	3 x 82.2	19.7 / 18.6	84.4 x 190	1.1	3
PhMKPg440.3.16,90-A84	5343-48512-xx	16.9	15	3 x 92.6	22.2 / 20.9	84.4 x 190	1.2	3
PhMKPg440.3.18,80-A84	5343-48513-xx	18.8	16.67	3 x 103.0	24.7 / 23.3	84.4 x 265	1.3	3
PhMKPg440.3.20,00-A84	5343-48514-xx	20	17.8	3 x 109.6	26.2 / 24.8	84.4 x 265	1.4	3
PhMKPg440.3.22,50-A84	5343-48515-xx	22.5	20	3 x 123.3	29.5 / 27.8	84.4 x 265	1.4	3
PhMKPg440.3.25,00-A84	5343-48516-xx	25	22.2	3 x 137.0	32.8 / 30.9	84.4 x 265	1.5	3
PhMKPg440.3.28,10-A84	5343-48517-xx	28.1	25	3 x 154.0	36.9 / 34.8	84.4 x 265	1.5	3
PhMKPg440.3.30,00-A84	5343-48518-xx	30	26.7	3 x 164.4	39.4 / 37.1	84.4 x 340	1.8	3
PhMKPg440.3.14,10-B116	5343-47269-xx	14.1	12.5	3 x 77.0	18.5 / 17.5	116 x 160	1.0	4
PhMKPg440.3.18,80-B116	5343-47217-xx	18.8	16.67	3 x 103.0	24.7 / 23.3	116 x 160	1.5	4
PhMKPg440.3.20,00-B116	5343-47218-xx	20	17.8	3 x 109.6	26.2 / 24.8	116 x 160	1.6	4
PhMKPg440.3.22,50-B116	5343-47219-xx	22.5	20	3 x 123.3	29.5 / 27.8	116 x 160	1.6	4
PhMKPg440.3.25,00-B116	5343-47220-xx	25	22.2	3 x 137.0	32.8 / 30.9	116 x 190	1.7	4
PhMKPg440.3.28,10-B116	5343-47205-xx	28.1	25	3 x 154.0	36.9 / 34.8	116 x 190	1.6	4
PhMKPg440.3.30,00-B136	5343-47501-xx	30	26.7	3 x 164.4	39.4 / 37.1	136 x 190	1.9	5
PhMKPg440.3.33,00-B136	5343-47502-xx	33	29.4	3 x 180.9	43.3 / 40.9	136 x 190	2.0	5

Notes

- Other voltage ratings, outputs, and frequencies upon request. All PhMKP-type capacitors may be also be applied in 60 Hz networks, output and current will, however, be 20 % higher in these cases (i.e. additional thermal load and therefore, a lower class of temperature must be taken into account)
- (1) Version no. xx may differ as it respects small changes, e.g. on the label



3-PHASE CAPACITORS

IP20, DRY

RATED VOLTAGE 525 V, 50 Hz, DELTA CONNECTION, UL / ULC								
CAN BE USED ALSO FOR 480 V								
TYPE	ARTICLE NO. ⁽¹⁾	OUTPUT kvar 525 V	OUTPUT kvar 480 V	CAP. µF	CURRENT A 525 V / 480 V	DIMENSIONS Ø x H mm	WEIGHT kg	DRAWING NO.
PhMKPg525.3.03,00-A64	5343-48215-xx	3	2.5	3 x 11.5	3.3 / 3.0	64 x 190	0.6	1
PhMKPg525.3.05,00-A64	5343-48216-xx	5	4.2	3 x 19.2	5.5 / 5.0	64 x 190	0.6	1
PhMKPg525.3.08,33-A64	5343-48217-xx	8.33	7	3 x 32.1	9.2 / 8.4	64 x 190	0.6	1
PhMKPg525.3.10,00-A64	5343-48218-xx	10	8.33	3 x 38.5	11.0 / 10.1	64 x 265	0.7	1
PhMKPg525.3.10,00-A84	5343-48519-xx	10	8.33	3 x 38.5	11.0 / 10.1	84.4 x 190	0.8	3
PhMKPg525.3.12,50-A84	5343-48520-xx	12.5	10.4	3 x 48.1	13.7 / 12.6	84.4 x 190	1.0	3
PhMKPg525.3.13.80-A84	5343-48521-xx	13.8	11.5	3 x 53.1	15.2 / 13.8	84.4 x 190	1.0	3
PhMKPg525.3.15,00-A84	5343-48522-xx	15	12.5	3 x 57.7	16.5 / 15.0	84.4 x 190	1.2	3
PhMKPg525.3.20,00-A84	5343-48523-xx	20	16.7	3 x 77.0	22.0 / 20.1	84.4 x 265	1.3	3
PhMKPg525.3.25,00-A84	5343-48524-xx	25	20.9	3 x 96.2	27.5 / 25.1	84.4 x 265	1.5	3
PhMKPg525.3.20,00-B116	5343-47266-xx	20	16.7	3 x 77.0	22.0 / 20.1	116 x 160	1.4	4
PhMKPg525.3.25,00-B116	5343-47227-xx	25	20.9	3 x 96.2	27.5 / 25.1	116 x 190	1.5	4
PhMKPg525.3.30,00-B116	5343-47267-xx	30	25.1	3 x 115.4	33.0 / 30.2	116 x 230	2.0	4
PhMKPg525.3.30,00-B136	5343-47503-xx	30	25.1	3 x 115.4	33.0 / 30.2	136 x 190	1.8	5
PhMKPg525.3.35,90-B116	5343-47271-xx	35.9	30	3 x 138.2	39.5 / 36.1	116 x 265	2.1	4
PhMKPg525.3.35,90-B136	5343-47504-xx	35.9	30	3 x 138.2	39.5 / 36.1	136 x 230	2.1	5
PhMKPg525.3.37,10-B116	5343-47272-xx	37.1	31	3 x 142.8	40.8 / 37.3	116 x 265	2.2	4
PhMKPg525.3.37,10-B136	5343-47505-xx	37.1	31	3 x 142.8	40.8 / 37.3	136 x 230	2.2	5

Notes

- Other voltage ratings, outputs, and frequencies upon request. All PhMKP-type capacitors may be also be applied in 60 Hz networks, output and current will, however, be 20 % higher in these cases (i.e. additional thermal load and therefore, a lower class of temperature must be taken into account)
- (1) Version no. xx may differ as it respects small changes, e.g. on the label



3-PHASE CAPACITORS

IP20, DRY

RATED VOLTAGE 660 V, 50 Hz, 64 / 84: DELTA CONNECTION, 116 / 136: STAR CONNECTION, UL / ULC UP TO 660 V								
CAN BE USED ALSO FOR 690 V, FULL OVER VOLTAGE RANGE								
TYPE	ARTICLE NO. ⁽¹⁾	OUTPUT kvar 660 V	OUTPUT kvar 690 V	CAP. µF	CURRENT A 660 V / 690 V	DIMENSIONS Ø x H mm	WEIGHT kg	DRAWING NO.
PhMKPg660.3.05,00-A64	5343-48219-xx	5	5.5	3 x 12.2	4.4 / 4.6	64 x 190	0.6	1
PhMKPg660.3.08,33-A64	5343-48220-xx	8.33	9.1	3 x 20.3	7.3 / 7.6	64 x 265	0.8	1
PhMKPg660.3.08,33-A84	5343-48525-xx	8.33	9.1	3 x 20.3	7.3 / 7.6	84.4 x 190	0.9	3
PhMKPg660.3.10,00-A84	5343-48526-xx	10	10.9	3 x 24.4	8.7 / 9.1	84.4 x 190	1.1	3
PhMKPg660.3.12,50-A84	5343-48527-xx	12.5	13.7	3 x 30.4	10.9 / 11.4	84.4 x 265	1.2	3
PhMKPg660.3.15,00-A84	5343-48528-xx	15	16.4	3 x 36.5	13.1 / 13.7	84.4 x 265	1.4	3
PhMKPg660.3.16,70-A84	5343-48529-xx	16.7	18.3	3 x 40.7	14.6 / 15.3	84.4 x 265	1.5	3
PhMKPg660.3.20,00-A84	5343-48530-xx	20	21.9	3 x 48.7	17.5 / 18.3	84.4 x 340	1.7	3
PhMKPg660.3.22,90-A84	5343-48531-xx	22.9	25	3 x 55.8	20 / 20.9	84.4 x 340	1.9	3
PhMKPg660.2.12,50-B116	5343-47255-xx	12.5	13.7	3 x 91.4	10.9 / 11.4	116 x 160	1.6	4
PhMKPg660.2.15,00-B116	5343-47256-xx	15	16.4	3 x 109.6	13.1 / 13.7	116 x 160	1.6	4
PhMKPg660.2.16,70-B116	5343-47257-xx	16.7	18.3	3 x 122.1	14.6 / 15.3	116 x 160	1.7	4
PhMKPg660.2.20,00-B116	5343-47259-xx	20	21.9	3 x 146.2	17.5 / 18.3	116 x 190	1.8	4
PhMKPg660.2.22,90-B116	5343-47273-xx	22.9	25	3 x 167.3	20 / 20.9	116 x 190	1.7	4
PhMKPg660.2.25,00-B136	5343-47506-xx	25	27.3	3 x 182.7	21.9 / 22.9	136 x 190	1.6	5
PhMKPg660.2.30,00-B136	5343-47507-xx	30	32.8	3 x 219.2	26.2 / 27.4	136 x 230	2.2	5

RATED VOLTAGE 690 V, 50 Hz, 64 / 84: DELTA CONNECTION, 116 / 136: STAR CONNECTION								
CAN BE USED ALSO FOR 660 V								
TYPE	ARTICLE NO. ⁽¹⁾	OUTPUT kvar 690 V	OUTPUT kvar 660 V	CAP. µF	CURRENT A 690 V / 660 V	DIMENSIONS Ø x H mm	WEIGHT kg	DRAWING NO.
PhMKPg690.3.10,00-A64	5343-48221-xx	10	9.1	3 x 22.3	8.4 / 8.0	64 x 265	0.9	1
PhMKPg690.3.12,50-A84	5343-48532-xx	12.5	11.4	3 x 27.9	10.5 / 10.0	84.4 x 265	1.1	3
PhMKPg690.3.15,00-A84	5343-48533-xx	15	13.7	3 x 33.4	12.5 / 12.0	84.4 x 265	1.3	3
PhMKPg690.3.20,00-A84	5343-48534-xx	20	18.3	3 x 44.6	16.7 / 16.0	84.4 x 340	1.6	3
PhMKPg690.3.25,00-A84	5343-48535-xx	25	22.9	3 x 55.7	20.9 / 20.0	84.4 x 340	1.9	3
PhMKPg690.2.12,50-B116	5343-47274-xx	12.5	11.4	3 x 83.6	10.5 / 10.0	116 x 160	1.2	4
PhMKPg690.2.15,00-B116	5343-47275-xx	15	13.7	3 x 100.3	12.5 / 12.0	116 x 160	1.3	4
PhMKPg690.2.20,00-B116	5343-47276-xx	20	18.3	3 x 133.7	16.7 / 16.0	116 x 190	1.5	4
PhMKPg690.2.25,00-B116	5343-47277-xx	25	22.9	3 x 167.3	20.9 / 20.0	116 x 190	1.6	4

Notes

- Other voltage ratings, outputs, and frequencies upon request. All PhMKPg-type capacitors may be also be applied in 60 Hz networks, output and current will, however, be 20 % higher in these cases (i.e. additional thermal load and therefore, a lower class of temperature must be taken into account)
- ⁽¹⁾ Version no. xx may differ as it respects small changes, e.g. on the label



1-PHASE CAPACITORS

OIL

RATED VOLTAGE 230 V, 50 Hz, UL / ULC								
TYPE	ARTICLE NO. (1)	OUTPUT kvar	CAP. μ F	CURRENT A	DIMENSIONS \varnothing x H (mm)	WEIGHT kg	DRAWING NO.	PROTECTIVE CLASS
IP20								
PhMKP230.1.02,50-A64	5341-48342-xx	2.5	150.0	10.9	64 x 140	0.6	1	IP20
PhMKP230.1.03,33-A64	5341-48323-xx	3.33	200.4	14.5	64 x 190	0.7	1	IP20
PhMKP230.1.04,17-A64	5341-48324-xx	4.17	251.0	18.1	64 x 190	0.8	1	IP20
IP00								
PhMKP230.1.05,00-A84	5341-48636-xx	5	300.0	21.7	84.4 x 140	0.9	3	IP20
IP00								
PhMKP230.1.05,00-84	5341-44436-xx	5	300.0	21.7	84.4 x 140	0.9	2	IP00

RATED VOLTAGE 400 V, 50 Hz, UL / ULC									
CAN BE USED ALSO FOR 415 V, FULL OVER VOLTAGE RANGE									
TYPE	ARTICLE NO. (1)	OUTPUT kvar 400 V	OUTPUT kvar 415 V	CAP. μ F	CURRENT A 400 V / 415 V	DIMENSIONS \varnothing x H mm	WEIGHT kg	DRAWING NO.	PROTECTIVE CLASS
IP20									
PhMKP400.1.02,50-A64	5341-48325-xx	2.5	2.7	49.7	6.3 / 6.5	64 x 82	0.3	1	IP20
PhMKP400.1.03,33-A64	5341-48326-xx	3.33	3.6	66.2	8.3 / 8.6	64 x 109	0.4	1	IP20
PhMKP400.1.05,00-A64	5341-48327-xx	5	5.4	99.5	12.5 / 13.0	64 x 140	0.5	1	IP20
PhMKP400.1.06,67-A64	5341-48328-xx	6.67	7.2	132.7	16.7 / 17.3	64 x 190	0.7	1	IP20
PhMKP400.1.08,33-A64	5341-48329-xx	8.33	9	165.7	20.8 / 21.6	64 x 190	0.8	1	IP20
PhMKP400.1.10,00-A64	5341-48330-xx	10	10.8	198.9	25.0 / 25.9	64 x 240	0.9	1	IP20
IP00									
PhMKP400.1.08,33-A84	5341-48637-xx	8.33	9	165.7	20.8 / 21.6	84.4 x 140	0.9	3	IP20
PhMKP400.1.10,00-A84	5341-48638-xx	10	10.8	198.9	25.0 / 25.9	84.4 x 140	1.0	3	IP20
PhMKP400.1.16,70-A84	5341-48639-xx	16.7	18	332.2	41.7 / 43.3	84.4 x 240	1.3	3	IP20
IP00									
PhMKP400.1.08,33-84	5341-44437-xx	8.33	9	165.7	20.8 / 21.6	84.4 x 140	0.9	2	IP00
PhMKP400.1.10,00-84	5341-44438-xx	10	10.8	198.9	25.0 / 25.9	84.4 x 140	1.0	2	IP00
PhMKP400.1.16,70-84	5341-44439-xx	16.7	18	332.2	41.7 / 43.3	84.4 x 240	1.3	2	IP00

RATED VOLTAGE 525 V, 50 Hz, UL / ULC									
CAN BE USED ALSO FOR 480 V									
TYPE	ARTICLE NO. (1)	OUTPUT kvar 525 V	OUTPUT kvar 480 V	CAP. μ F	CURRENT A 525 V / 480 V	DIMENSIONS \varnothing x H mm	WEIGHT kg	DRAWING NO.	PROTECTIVE CLASS
IP20									
PhMKP525.1.05,00-A64	5341-48331-xx	5	4.2	57.7	9.5 / 8.8	64 x 140	0.5	1	IP20
PhMKP525.1.08,33-A64	5341-48332-xx	8.33	7.0	96.2	15.9 / 14.6	64 x 190	0.7	1	IP20
PhMKP525.1.10,00-A64	5341-48333-xx	10	8.4	115.5	19.0 / 17.5	64 x 240	0.9	1	IP20
IP00									
PhMKP525.1.16,70-A84	5341-48640-xx	16.7	14.0	192.9	31.6 / 29.2	84.4 x 240	1.3	3	IP20
PhMKP525.1.20,00-A84	5341-48641-xx	20	16.7	231.0	38.0 / 34.8	84.4 x 240	1.3	3	IP20
IP00									
PhMKP525.1.16,70-84	5341-44440-xx	16.7	14.0	192.9	31.6 / 29.2	84.4 x 240	1.3	2	IP00
PhMKP525.1.20,00-84	5341-44441-xx	20	16.7	231.0	38.0 / 34.8	84.4 x 240	1.3	2	IP00

Notes

- Other voltage ratings, outputs, and frequencies upon request. All PhMKP-type capacitors may be also be applied in 60 Hz networks, output and current will, however, be 20 % higher in these cases (i.e. additional thermal load and therefore, a lower class of temperature must be taken into account)

(1) Version no. xx may differ as it respects small changes, e.g. on the label



DIMENSIONS

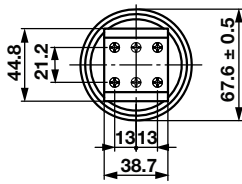
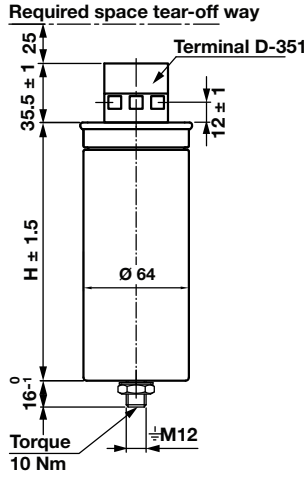

Drawing 1

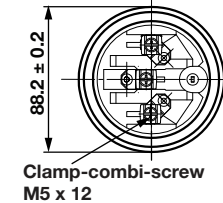
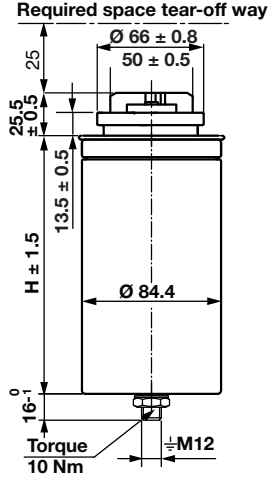

Drawing 2

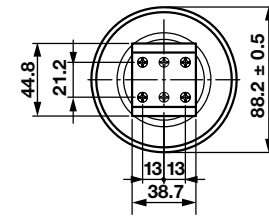
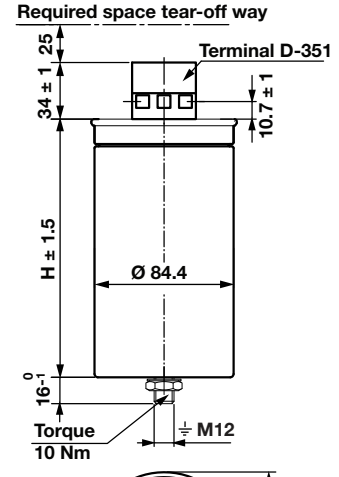

Drawing 3

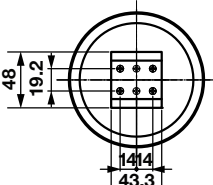
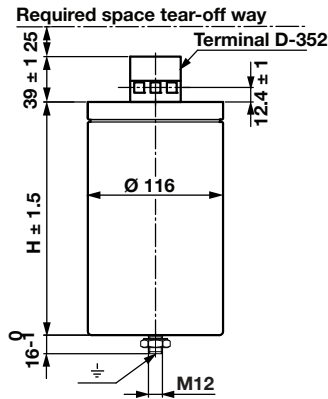

Drawing 4

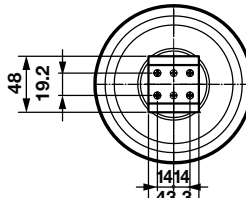
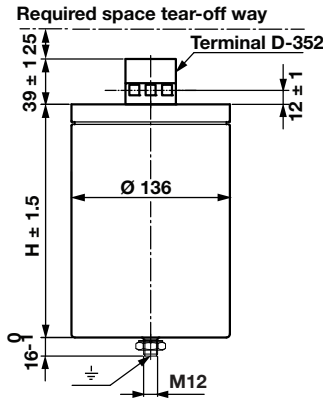

Drawing 5

ORDERING INFORMATION

TECHNICAL UNITS

Full cardboard boxes:	Ø 64 mm - 9 pcs per carton
	Ø 84.4 mm - 4 pcs per carton
	Ø 116 mm - 4 pcs per carton
	Ø 136 mm - 2 pcs per carton



Disclaimer

ALL PRODUCT, PRODUCT SPECIFICATIONS AND DATA ARE SUBJECT TO CHANGE WITHOUT NOTICE TO IMPROVE RELIABILITY, FUNCTION OR DESIGN OR OTHERWISE.

Vishay Intertechnology, Inc., its affiliates, agents, and employees, and all persons acting on its or their behalf (collectively, "Vishay"), disclaim any and all liability for any errors, inaccuracies or incompleteness contained in any datasheet or in any other disclosure relating to any product.

Vishay makes no warranty, representation or guarantee regarding the suitability of the products for any particular purpose or the continuing production of any product. To the maximum extent permitted by applicable law, Vishay disclaims (i) any and all liability arising out of the application or use of any product, (ii) any and all liability, including without limitation special, consequential or incidental damages, and (iii) any and all implied warranties, including warranties of fitness for particular purpose, non-infringement and merchantability.

Statements regarding the suitability of products for certain types of applications are based on Vishay's knowledge of typical requirements that are often placed on Vishay products in generic applications. Such statements are not binding statements about the suitability of products for a particular application. It is the customer's responsibility to validate that a particular product with the properties described in the product specification is suitable for use in a particular application. Parameters provided in datasheets and / or specifications may vary in different applications and performance may vary over time. All operating parameters, including typical parameters, must be validated for each customer application by the customer's technical experts. Product specifications do not expand or otherwise modify Vishay's terms and conditions of purchase, including but not limited to the warranty expressed therein.

Except as expressly indicated in writing, Vishay products are not designed for use in medical, life-saving, or life-sustaining applications or for any other application in which the failure of the Vishay product could result in personal injury or death. Customers using or selling Vishay products not expressly indicated for use in such applications do so at their own risk. Please contact authorized Vishay personnel to obtain written terms and conditions regarding products designed for such applications.

No license, express or implied, by estoppel or otherwise, to any intellectual property rights is granted by this document or by any conduct of Vishay. Product names and markings noted herein may be trademarks of their respective owners.