

Low Power Through-Hole Transformer Dual Primary - Dual Secondary 115 V/230 V

PL-22, PL-23, PL-24

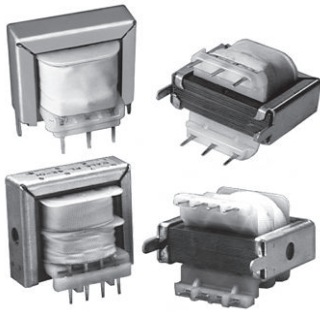

PL-42, PL-43, PL-44

ELECTRICAL SPECIFICATIONS

Input Voltage: 115 V 60 Hz or 230 V 50 Hz to 60 Hz

Output Power Rating:

PL-22, PL-42 = 1.5 VA

PL-23, PL-43 = 4.5 VA

PL-24, PL-44 = 10.0 VA

Dielectric Strength: Between primary windings and secondary windings and core:

PL-22, PL-23, PL-24 = 1500 V

PL-42, PL-43, PL-44 = 2500 V

Between secondary windings to core: All units = 1000 V

From primary to primary windings: All units = 500 V

From secondary to secondary windings: All units = 500 V

MECHANICAL SPECIFICATIONS

Temperature Class:

PL22, PL-23, PL-24: Insulation Class A, 105 °C

PL-42, PL43, PL-44: Insulation Class B, 130 °C

A UL approved Class B Insulation System can be finished on request.

Terminals: Brass, solder coated

Weight: (reference)

PL-22, PL-42 = 100 g

PL-23, PL-43 = 160 g

PL-24, PL-44 = 240 g

FEATURES

- PC pin mounting
- Provides isolation from power line
- Dual Primary for operation at 115 V or 230 V, 50 Hz/60 Hz
- Dual Secondary for **series connection** obtains twice winding voltage with center tap or for **parallel connection** obtains twice winding current rating
- Modification to these standard items are available as speciality products
- Laminated construction for low-cost industrial applications, including power supplies, controls and instrumentation
- Mounting brackets and bobbin standoff are available
- **PL-22, PL-23, PL-24:** Concentric windings for increased coupling, decreased leakage reactance and improved regulation
- **PL-42, PL-43, PL-44:** Split-section winding for increased dielectric strength between primary and secondary windings plus reduced interwinding capacitance
- Compliant to RoHS Directive 2002/95/EC



RoHS
COMPLIANT

SCHEMATICS

Basic Style

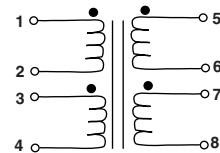

Options

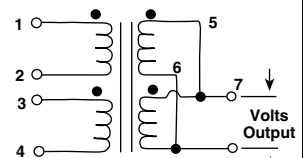
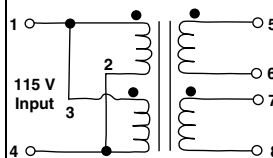
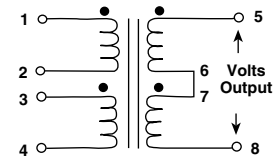
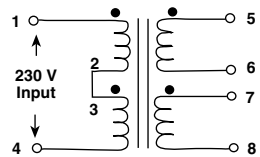



OUTPUT VOLTAGE TABLE					
MODEL		OUTPUT VOLTAGE		OUTPUT CURRENT (mA)	
CONCENTRIC WINDINGS	SPLIT-SECTION WINDINGS	SERIES	PARALLEL	SERIES	PARALLEL
PL-22-01 PL-23-01 PL-24-01	PL-42-01 PL-43-01 PL-44-01	8 VCT	4 V	188 562 940	376 1124 1880
PL-22-02 PL-23-02 PL-24-02	PL-42-02 PL-43-02 PL-44-02	10 VCT	5 V	120 440 1000	240 880 2000
PL-22-03 PL-23-03 PL-24-03	PL-42-03 PL-43-03 PL-44-03	12.6 VCT	6.3 V	100 350 800	200 700 1600
PL-22-04 PL-23-04 PL-24-04	PL-42-04 PL-43-04 PL-44-04	15 VCT	7.5 V	100 300 500	200 600 1000
PL-22-05 PL-23-05 PL-24-05	PL-42-05 PL-43-05 PL-44-05	16 VCT	8 V	75 260 640	150 520 1280
PL-22-06 PL-23-06 PL-24-06	PL-42-06 PL-43-06 PL-44-06	20 VCT	10 V	60 220 500	120 440 1000
PL-22-07 PL-23-07 PL-24-07	PL-42-07 PL-43-07 PL-44-07	24 VCT	12 V	50 180 450	100 360 900
PL-22-08 PL-23-08 PL-24-08	PL-42-08 PL-43-08 PL-44-08	30 VCT	15 V	50 150 250	100 300 500
PL-22-09 PL-23-09 PL-24-09	PL-42-09 PL-43-09 PL-44-09	34 VCT	17 V	35 125 300	70 250 600
PL-22-10 PL-23-10 PL-24-10	PL-42-10 PL-43-10 PL-44-10	40 VCT	20 V	30 110 250	60 220 500
PL-22-11 PL-23-11 PL-24-11	PL-42-11 PL-43-11 PL-44-11	54 VCT	27 V	28 84 140	56 168 280
PL-22-12 PL-23-12 PL-24-12	PL-42-12 PL-43-12 PL-44-12	56 VCT	28 V	20 80 180	40 160 360
PL-22-13 PL-23-13 PL-24-13	PL-42-13 PL-43-13 PL-44-13	76 VCT	38 V	20 60 100	40 120 200
PL-22-14 PL-23-14 PL-24-14	PL-42-14 PL-43-14 PL-44-14	88 VCT	44 V	15 20 120	30 100 240
PL-22-15 PL-23-15 PL-24-15	PL-42-15 PL-43-15 PL-44-15	120 VCT	60 V	10 35 85	20 70 170
PL-22-16 PL-23-16 PL-24-16	PL-42-16 PL-43-16 PL-44-16	180 VCT	90 V	6 24 55	12 48 110
PL-22-17 PL-23-17 PL-24-17	PL-42-17 PL-43-17 PL-44-17	230 VCT	115 V	5 20 40	10 40 80

DIMENSIONAL CONFIGURATIONS (Reference) [Numbers in brackets indicate millimeters]

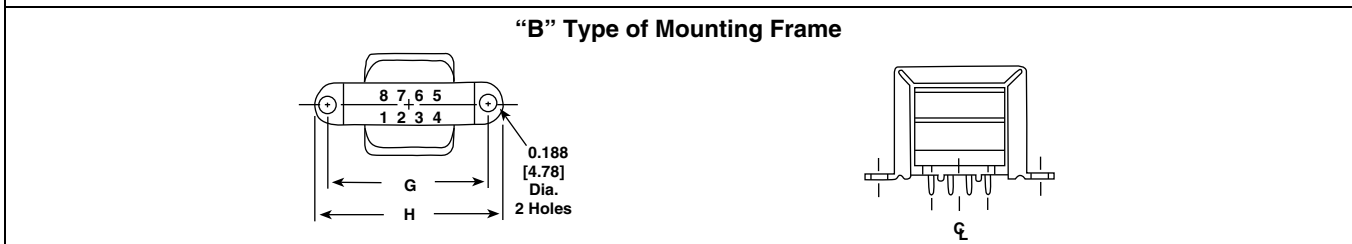
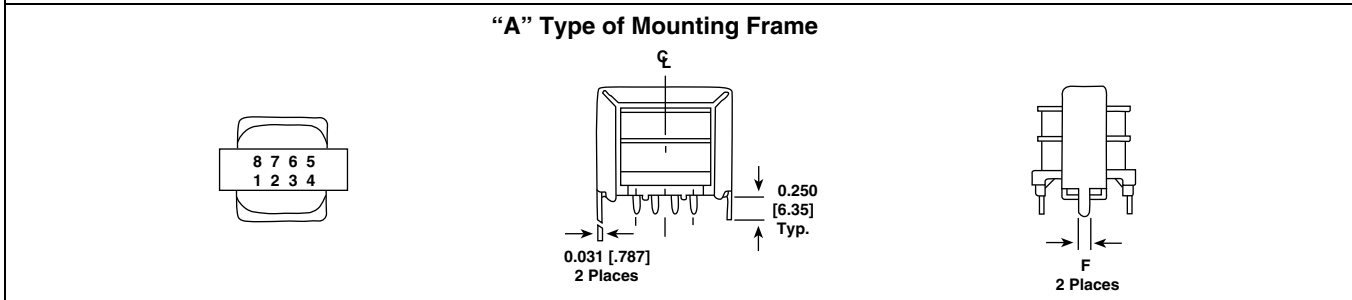
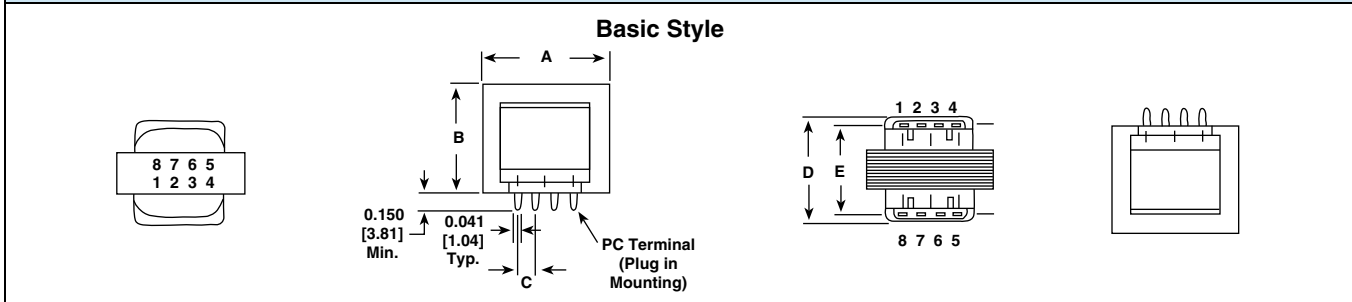

MODEL	A	B	C	D	E	F	G	H
PL-22	1.43	1.20	0.200	1.19	1.0	0.125	1.75	2.12
PL-42	[36.32]	[30.48]	[5.08]	[30.23]	[25.40]	[3.18]	[44.45]	[53.85]
PL-23	1.68	1.38	0.250	1.30	1.10	0.125	2.0	2.44
PL-43	[42.67]	[35.05]	[6.35]	[33.02]	[27.94]	[3.18]	[50.80]	[61.98]
PL-24	1.93	1.64	0.250	1.48	1.30	0.188	2.38	2.88
PL44	[49.02]	[41.66]	[6.35]	[37.59]	[33.02]	[4.78]	[60.45]	[73.15]

PART MARKING

- Vishay Dale
- Model
- Date code

ORDERING INFORMATION

MODEL	OUTPUT VOLTAGE AND CURRENT	MOUNTING FRAME (If not required, leave blank)	BOBBIN STANDOFF (If not required, leave blank)	PACKAGE CODE	JEDEC LEAD (Pb)-FREE STANDARD
PL-22	01	A	S	EB	e2

GLOBAL PART NUMBER

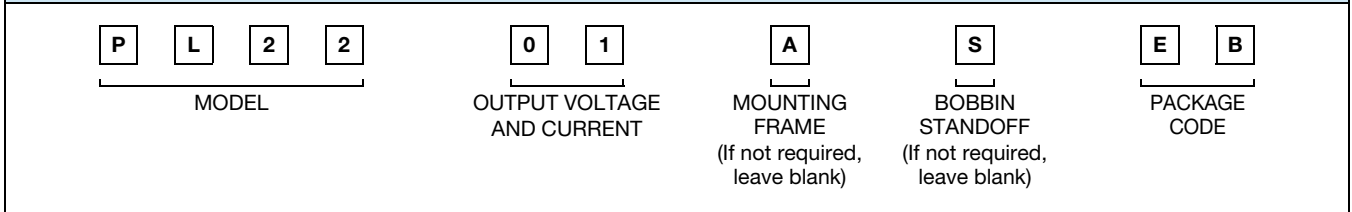



Disclaimer

ALL PRODUCT, PRODUCT SPECIFICATIONS AND DATA ARE SUBJECT TO CHANGE WITHOUT NOTICE TO IMPROVE RELIABILITY, FUNCTION OR DESIGN OR OTHERWISE.

Vishay Intertechnology, Inc., its affiliates, agents, and employees, and all persons acting on its or their behalf (collectively, "Vishay"), disclaim any and all liability for any errors, inaccuracies or incompleteness contained in any datasheet or in any other disclosure relating to any product.

Vishay makes no warranty, representation or guarantee regarding the suitability of the products for any particular purpose or the continuing production of any product. To the maximum extent permitted by applicable law, Vishay disclaims (i) any and all liability arising out of the application or use of any product, (ii) any and all liability, including without limitation special, consequential or incidental damages, and (iii) any and all implied warranties, including warranties of fitness for particular purpose, non-infringement and merchantability.

Statements regarding the suitability of products for certain types of applications are based on Vishay's knowledge of typical requirements that are often placed on Vishay products in generic applications. Such statements are not binding statements about the suitability of products for a particular application. It is the customer's responsibility to validate that a particular product with the properties described in the product specification is suitable for use in a particular application. Parameters provided in datasheets and/or specifications may vary in different applications and performance may vary over time. All operating parameters, including typical parameters, must be validated for each customer application by the customer's technical experts. Product specifications do not expand or otherwise modify Vishay's terms and conditions of purchase, including but not limited to the warranty expressed therein.

Except as expressly indicated in writing, Vishay products are not designed for use in medical, life-saving, or life-sustaining applications or for any other application in which the failure of the Vishay product could result in personal injury or death. Customers using or selling Vishay products not expressly indicated for use in such applications do so at their own risk and agree to fully indemnify and hold Vishay and its distributors harmless from and against any and all claims, liabilities, expenses and damages arising or resulting in connection with such use or sale, including attorneys fees, even if such claim alleges that Vishay or its distributor was negligent regarding the design or manufacture of the part. Please contact authorized Vishay personnel to obtain written terms and conditions regarding products designed for such applications.

No license, express or implied, by estoppel or otherwise, to any intellectual property rights is granted by this document or by any conduct of Vishay. Product names and markings noted herein may be trademarks of their respective owners.