

Precision Low TCR Thin Film Resistor, Surface Mount Chip, ± 5 ppm/°C TCR, 0.01 % Tolerance

Actual Size 0603

Vishay's proven precision thin film wraparound resistors will meet your exact requirements. These resistors are ideal for precision applications requiring low noise, stability, ultra low temperature coefficient of resistance, and low voltage coefficient. The chip resistors are available in any resistance ohmic value in the range specified below.

CONSTRUCTION

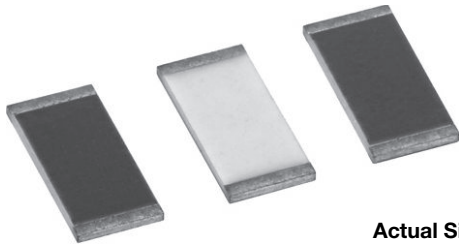
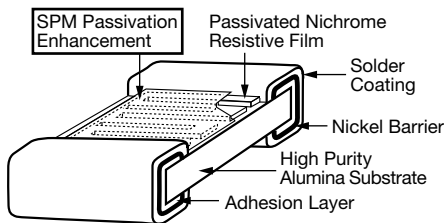

FEATURES

- TCR of ± 5 ppm/°C standard
- Tolerances to ± 0.01 %
- Anti corrosion resistant film with (SPM) special passivation method
- Stable film and performance characteristics ($\Delta R \pm 0.04\%$ at 70 °C, 10 000 h)
- Non-standard resistance values available
- Very low noise and voltage coefficient (< -30 dB, 0.1 ppm/V)
- UL 94 V-0 flame resistant
- Material categorization: for definitions of compliance please see www.vishay.com/doc?99912



Note

* This datasheet provides information about parts that are RoHS-compliant and/or parts that are non-RoHS-compliant. For example, parts with lead (Pb) terminations are not RoHS-compliant. Please see the information/tables in this datasheet for details.

TYPICAL PERFORMANCE

	ABSOLUTE
TCR	5
TOL.	0.01

STANDARD ELECTRICAL SPECIFICATIONS

TEST	SPECIFICATIONS	CONDITIONS
Material	Passivated nichrome	-
Resistance Range	50 Ω to 3 MΩ	-
TCR: Absolute	± 5 ppm/°C	-55 °C to +125 °C
Tolerance: Absolute	± 0.1 % to ± 0.01 %	+25 °C
Stability: Absolute	$\Delta R \pm 0.02\%$	2000 h at 70 °C
Stability: Ratio	-	-
Voltage Coefficient	± 0.1 ppm/V (typical)	-
Working Voltage	75 V to 200 V	-
Operating Temperature Range	-55 °C to +125 °C	-
Storage Temperature Range	-55 °C to +150 °C	-
Noise	< -35 dB (typical)	-
Shelf Life Stability: Absolute	$\Delta R \pm 0.01\%$	1 year at +25 °C

COMPONENT RATINGS

CASE SIZE	POWER RATING (mW)	WORKING VOLTAGE (V)	RESISTANCE RANGE (Ω)
0603	150	75	250 to 130K
0805	250	100	250 to 260K
1206	400	200	250 to 775K
2010	800	200	500 to 2M
2512	1000	200	500 to 3M

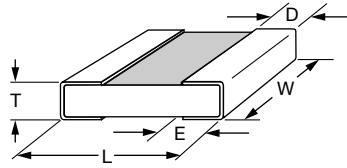
DIMENSIONS in inches

CASE SIZE	TERM	L	W	T	D	E
0603	B	0.064 ± 0.006	0.032 ± 0.005	0.020 max.	0.012 ± 0.005	0.015 ± 0.005
0805	B	0.080 ± 0.006	0.050 ± 0.005	0.015 to 0.033	0.016 ± 0.008	0.015 ± 0.005
1206	B	0.126 ± 0.008	0.063 ± 0.005	0.015 to 0.033	0.020 + 0.005/- 0.010	0.020 + 0.005/- 0.010
2010	G	0.209 ± 0.009	0.098 ± 0.005	0.015 to 0.033	0.020 ± 0.005	0.020 ± 0.005
2512	G	0.259 ± 0.009	0.124 ± 0.005	0.015 to 0.033	0.020 ± 0.005	0.020 ± 0.005

ENVIRONMENTAL TESTS - TYPICAL

ENVIRONMENTAL TEST	10 kΩ ΔR ± (%)	100 kΩ ΔR ± (%)
Thermal Shock	0.02	0.02
Short Time Overload	0.01	0.01
Low Temperature Operation	0.01	0.01
Resistance to Solder Heat	0.01	0.01
Moisture Resistance	0.02	0.02
High Temperature Exposure	0.02	0.02
Load Life (10 000 h, +70 °C)	0.04	0.04
TCR	± 5 ppm/°C	± 5 ppm/°C

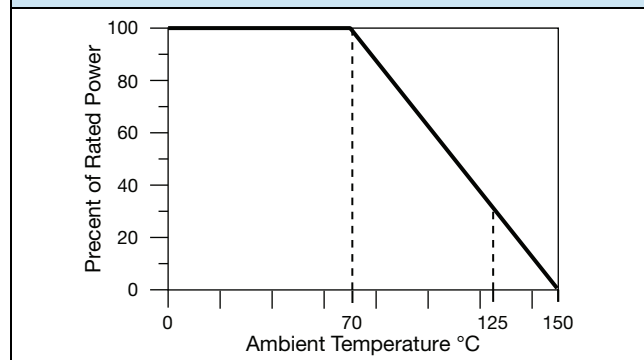
DERATING CURVE

GLOBAL PART NUMBER INFORMATION

GLOBAL MODEL	CASE SIZE	TCR CHARACTERISTIC	RESISTANCE	TOLERANCE	TERMINATION	PACKAGING
PLT	0603 0805 1206 2010 2512	Z = ± 5 ppm/°C	The first 3 digits are significant figures and the last digit specifies the number of zeros to follow. "R" designates the decimal point. Example: 1001 = 1 kΩ 2500 = 250 Ω Special values with more than 4 significant figures, use a R for value below 1 kΩ and a K for values greater than 1 kΩ to signify a decimal point. 982R6 = 982.6 Ω 532R41 = 532.41 Ω	L = ± 0.01 % ⁽²⁾ Q = ± 0.02 % A = ± 0.05 % B = ± 0.1 % D = ± 0.5 % F = ± 1 %	B = Wraparound Sn/Pb solder w/Ni barrier (63 % Sn/37 % Pb w/ nickel barrier) S = Wraparound lead (Pb)-free solder 96.5 % Sn/3.0 % Ag/ 0.5 % Cu RoHS compliant - e1	WS = WAFFLE PACK W1 = 100 min., 1 mult (item single lot date code) WP = 100 min., 1 mult (package unit single lot date code) TAPE AND REEL T0 = 100 min., 100 mult T1 = 1000 min., 1000 mult ⁽¹⁾ T3 = 300 min., 300 mult T5 = 500 min., 500 mult TF = Full reel TS = 100 min., 1 mult TI = 100 min., 1 mult (item single lot date code) TP = 100 min., 1 mult (package unit single lot date code)

Notes

- (1) Preferred packaging code
- (2) L and Q tolerances are available only for resistance values > 250 Ω.



Vishay Dale Thin Film Land Patterns

1. Scope

This technical note provides sample land patterns for Vishay Dale Thin Film SMT resistive products. The following drawings are based on IPC-SM-782 Surface Mount Design and Land Pattern Standard. These drawings are for reference only Vishay Thin Film recommends that the user contacts their PC board supplier for actual land patterns required. The pads are intended for lead (Pb)-free and tin / lead solder types.

2. Product Series

Thin Film Surface Mount Chip Resistors (FC, L, P, PTN, PLT, PLTT, PLTU, PAT, PATT, PNM, M/D55342 QPL Series)

0402 Land Pattern

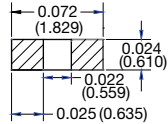

0502 Land Pattern

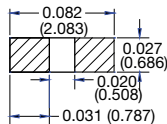

0505 Land Pattern

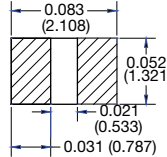

0603 Land Pattern

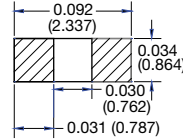

0705 Land Pattern

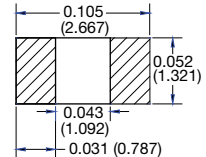

1005 Land Pattern

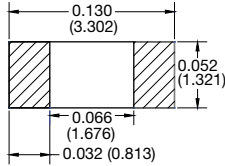

1010 Land Pattern

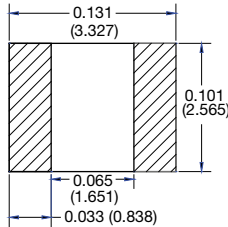

1206 Land Pattern

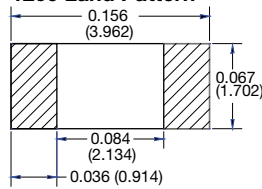

1505 Land Pattern

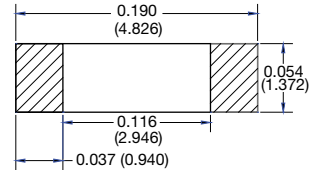

2010 Land Pattern

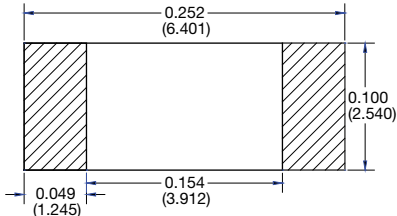

2208 Land Pattern

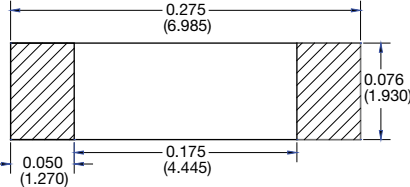

2512 Land Pattern

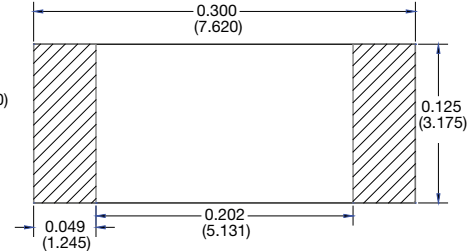



Thin Film Surface Mount Chip Resistors (PHP, PCAN Series)

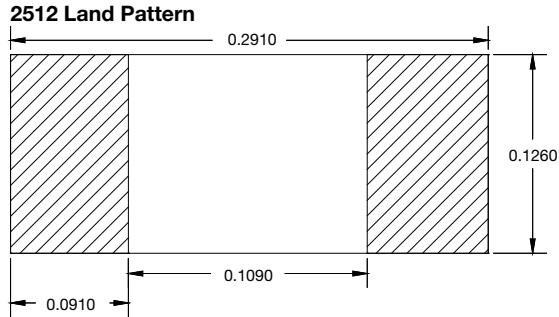
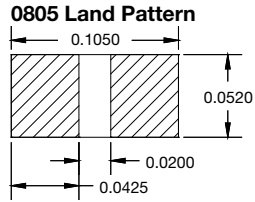
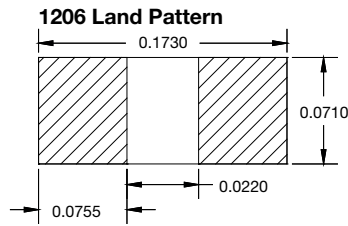
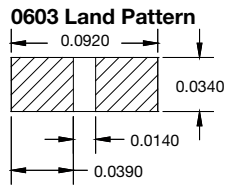

Thin Film Surface Mount Chip Resistors Long Axis Termination (L Series)

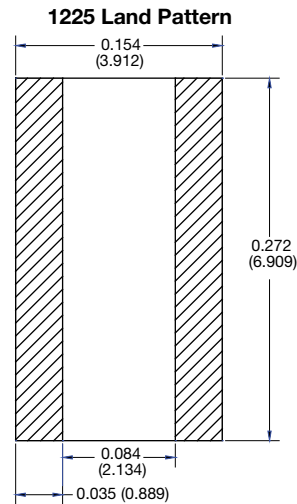
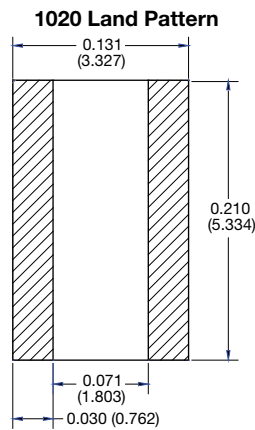
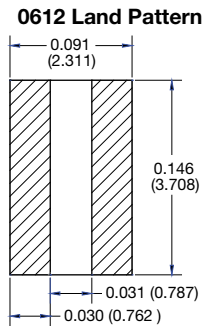
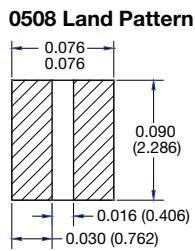



Surface Mount Networks (MPM, MP3, MP4 Series)

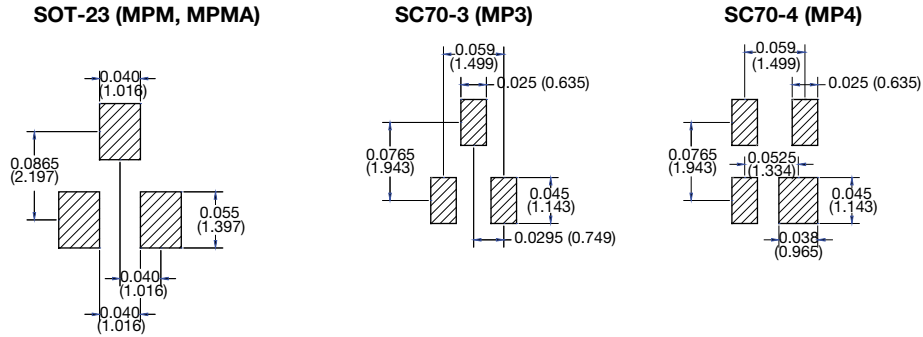

Surface Mount Networks SOIC Narrow Body 150 mils (ORN, CSO, MOMC, HTRN, AORN, MORN Series)

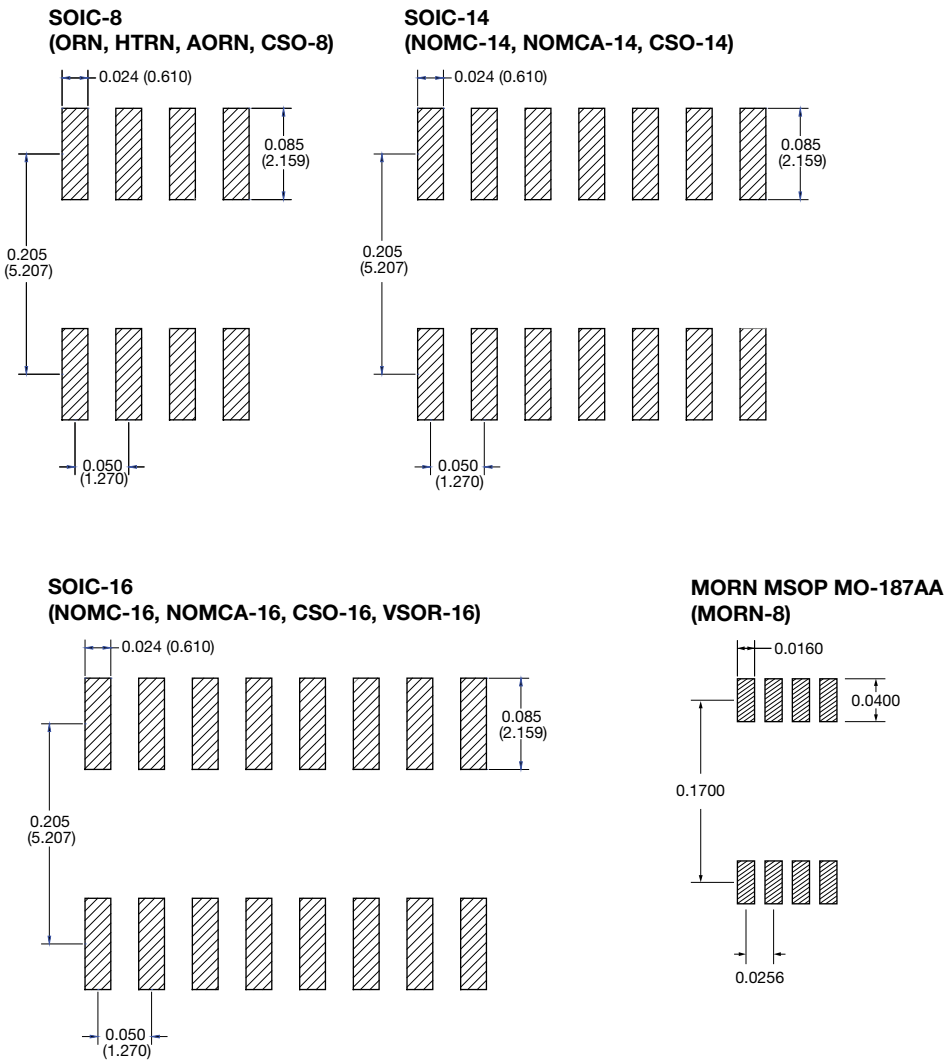



Surface Mount Networks SOIC Medium Body 220 mils (TOMC Series)

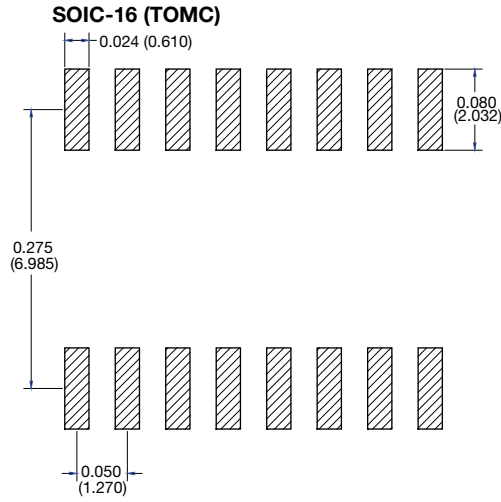

Surface Mount Networks SOIC Wide Body 300 mils (WOMC Series)

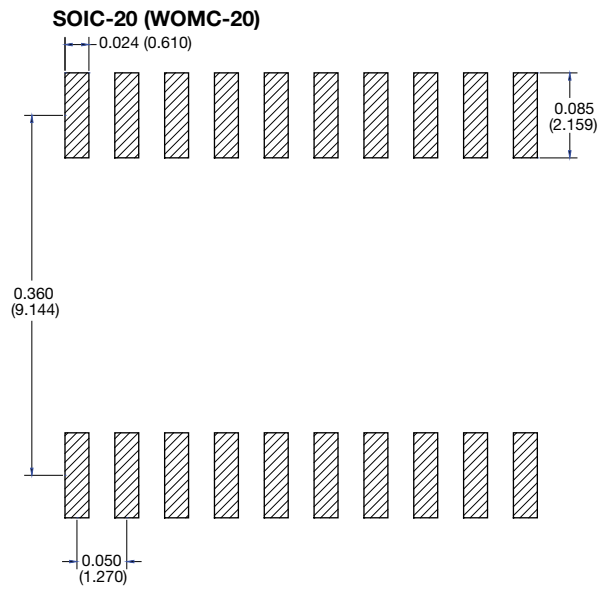
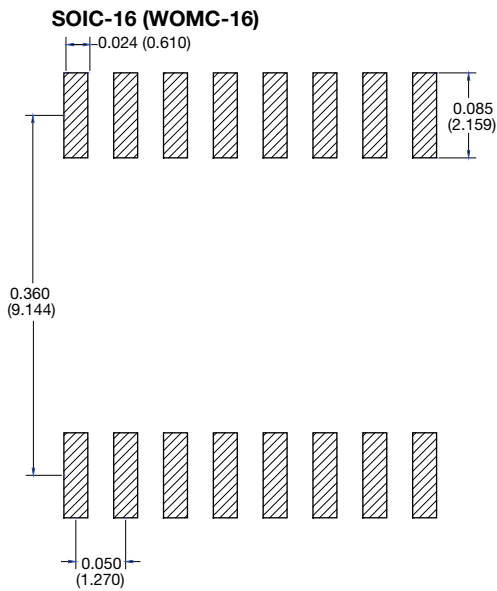



Surface Mount Networks High Density SSOP, TSOP (VSSR, VTSR Series)

SSOP MO-137

OSOP-16, VSSR-16

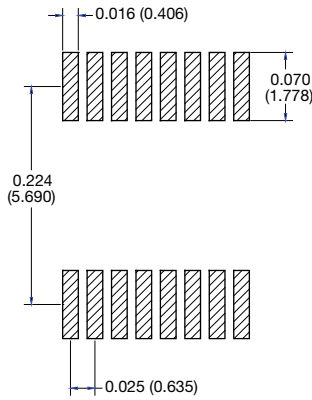

OSOP-20, VSSR-20

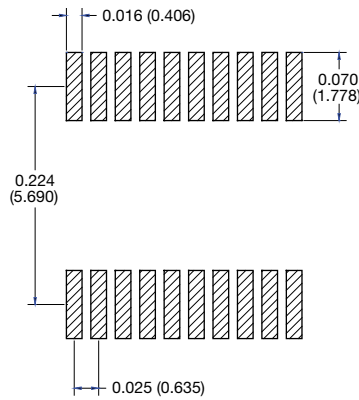

OSOP-24, VSSR-24, HD-CSO-24

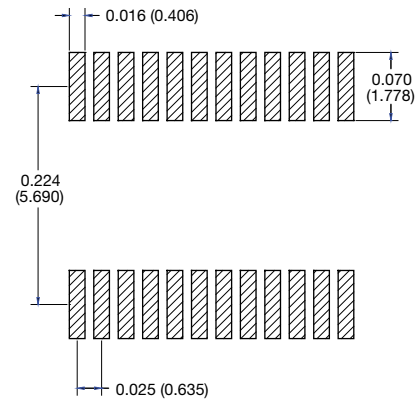

TSSOP MO-153

VTSR-16

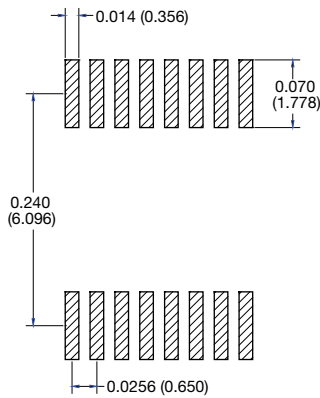

VTSR-20

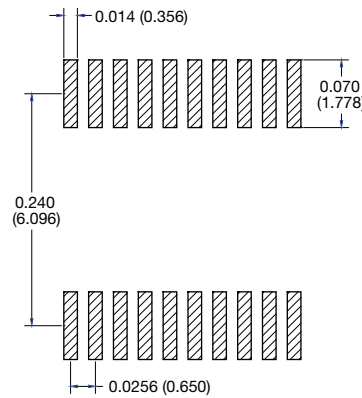

VTSR-24

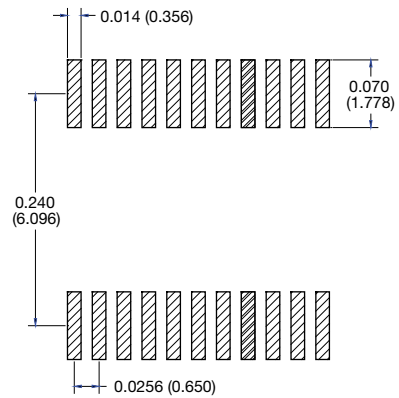

Surface Mount Leadless Networks (LCC Series)

16 Pin LCC

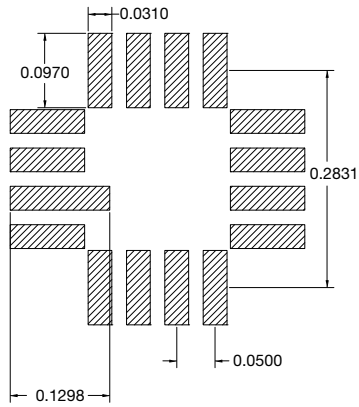

20 Pin LCC

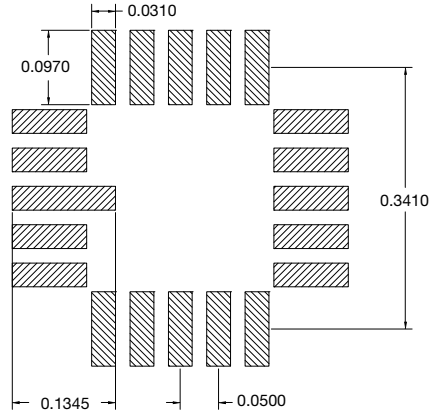

Surface Mount Leadless Networks (MPH Series)

4 Pin LCC

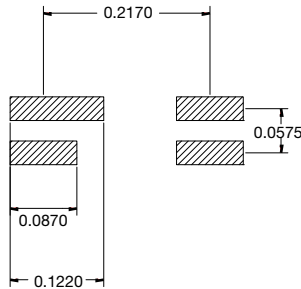

Surface Mount Leadless Packages DUAL/ QUAD Flat No Lead (DFN, QFN Series)

DFN MLP

DFN-8 4 x 5 mm Sq

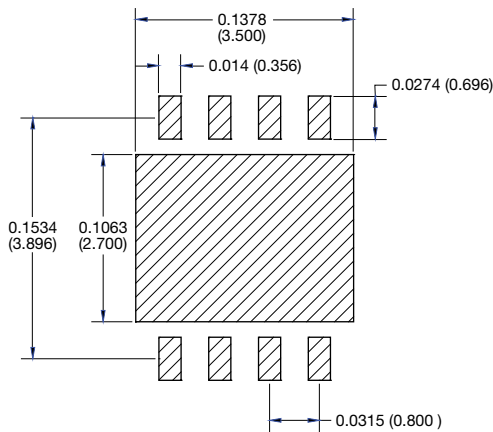

QFN MLP

QFN-20 5 x 5 mm Sq

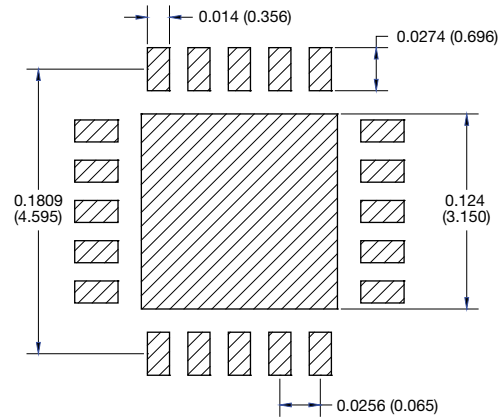

Surface Mount Leadless Resistor Arrays (PR Series)

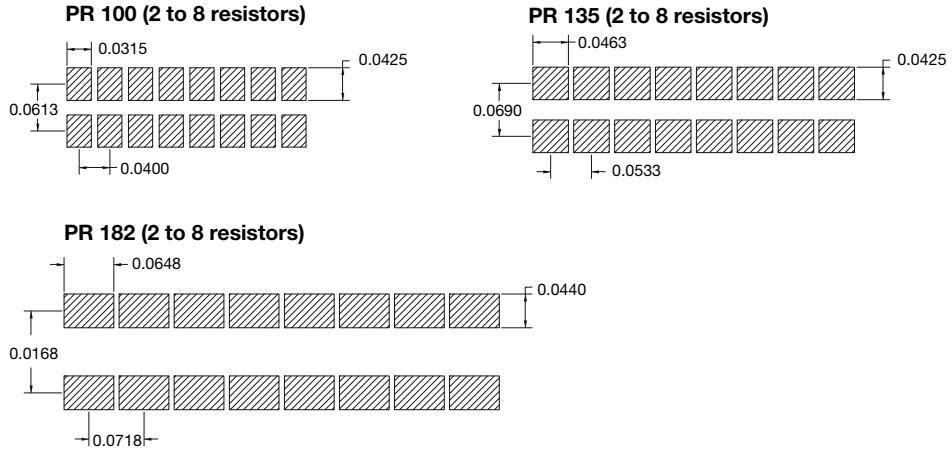

Note

- All dimensions in inches (mm)

Flatpack

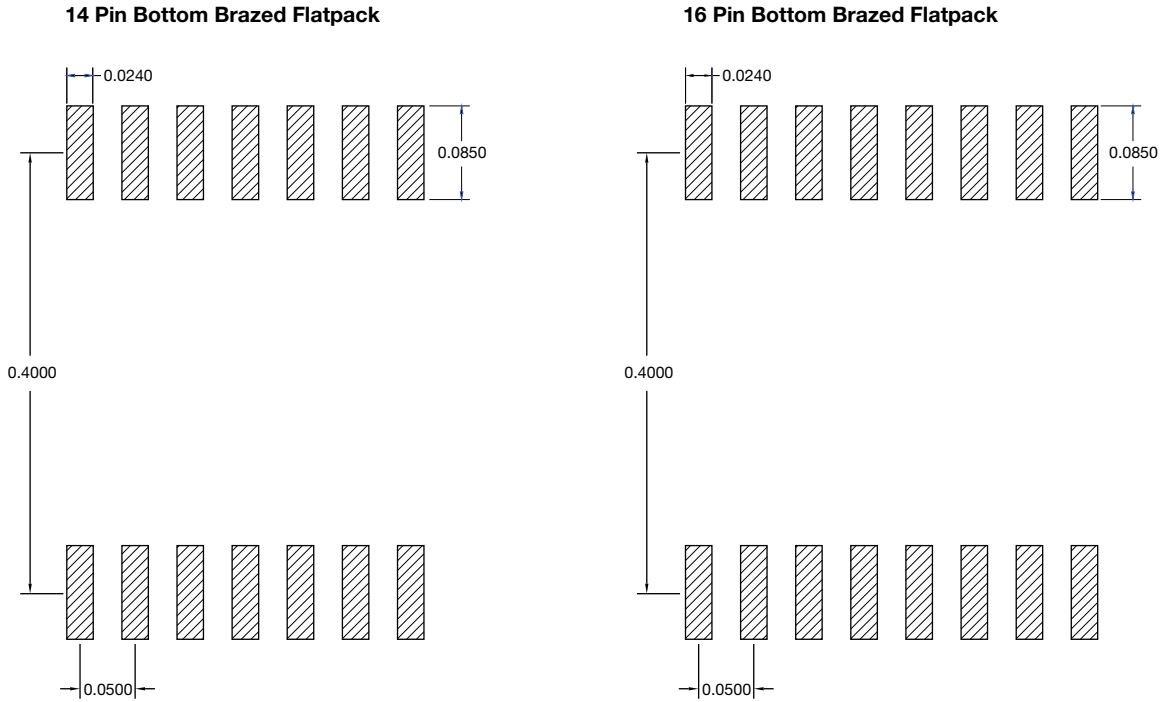



Disclaimer

ALL PRODUCT, PRODUCT SPECIFICATIONS AND DATA ARE SUBJECT TO CHANGE WITHOUT NOTICE TO IMPROVE RELIABILITY, FUNCTION OR DESIGN OR OTHERWISE.

Vishay Intertechnology, Inc., its affiliates, agents, and employees, and all persons acting on its or their behalf (collectively, "Vishay"), disclaim any and all liability for any errors, inaccuracies or incompleteness contained in any datasheet or in any other disclosure relating to any product.

Vishay makes no warranty, representation or guarantee regarding the suitability of the products for any particular purpose or the continuing production of any product. To the maximum extent permitted by applicable law, Vishay disclaims (i) any and all liability arising out of the application or use of any product, (ii) any and all liability, including without limitation special, consequential or incidental damages, and (iii) any and all implied warranties, including warranties of fitness for particular purpose, non-infringement and merchantability.

Statements regarding the suitability of products for certain types of applications are based on Vishay's knowledge of typical requirements that are often placed on Vishay products in generic applications. Such statements are not binding statements about the suitability of products for a particular application. It is the customer's responsibility to validate that a particular product with the properties described in the product specification is suitable for use in a particular application. Parameters provided in datasheets and / or specifications may vary in different applications and performance may vary over time. All operating parameters, including typical parameters, must be validated for each customer application by the customer's technical experts. Product specifications do not expand or otherwise modify Vishay's terms and conditions of purchase, including but not limited to the warranty expressed therein.

Except as expressly indicated in writing, Vishay products are not designed for use in medical, life-saving, or life-sustaining applications or for any other application in which the failure of the Vishay product could result in personal injury or death. Customers using or selling Vishay products not expressly indicated for use in such applications do so at their own risk. Please contact authorized Vishay personnel to obtain written terms and conditions regarding products designed for such applications.

No license, express or implied, by estoppel or otherwise, to any intellectual property rights is granted by this document or by any conduct of Vishay. Product names and markings noted herein may be trademarks of their respective owners.