

N- and P-Channel 30 V (D-S) 175 °C MOSFET

DESCRIPTION

The attached SPICE model describes the typical electrical characteristics of the n- and p-channel vertical DMOS. The subcircuit model is extracted and optimized over the - 55 °C to + 125 °C temperature ranges under the pulsed 0 V to 10 V gate drive. The saturated output impedance is best fit at the gate bias near the threshold voltage.

A novel gate-to-drain feedback capacitance network is used to model the gate charge characteristics while avoiding convergence difficulties of the switched C_{gd} model. All model parameter values are optimized to provide a best fit to the measured electrical data and are not intended as an exact physical interpretation of the device.

CHARACTERISTICS

- N- and P-Channel Vertical DMOS
- Macro Model (Subcircuit Model)
- Level 3 MOS
- Apply for both Linear and Switching Application
- Accurate over the - 55 °C to + 125 °C Temperature Range
- Model the Gate Charge, Transient, and Diode Reverse Recovery Characteristics

SUBCIRCUIT MODEL SCHEMATIC

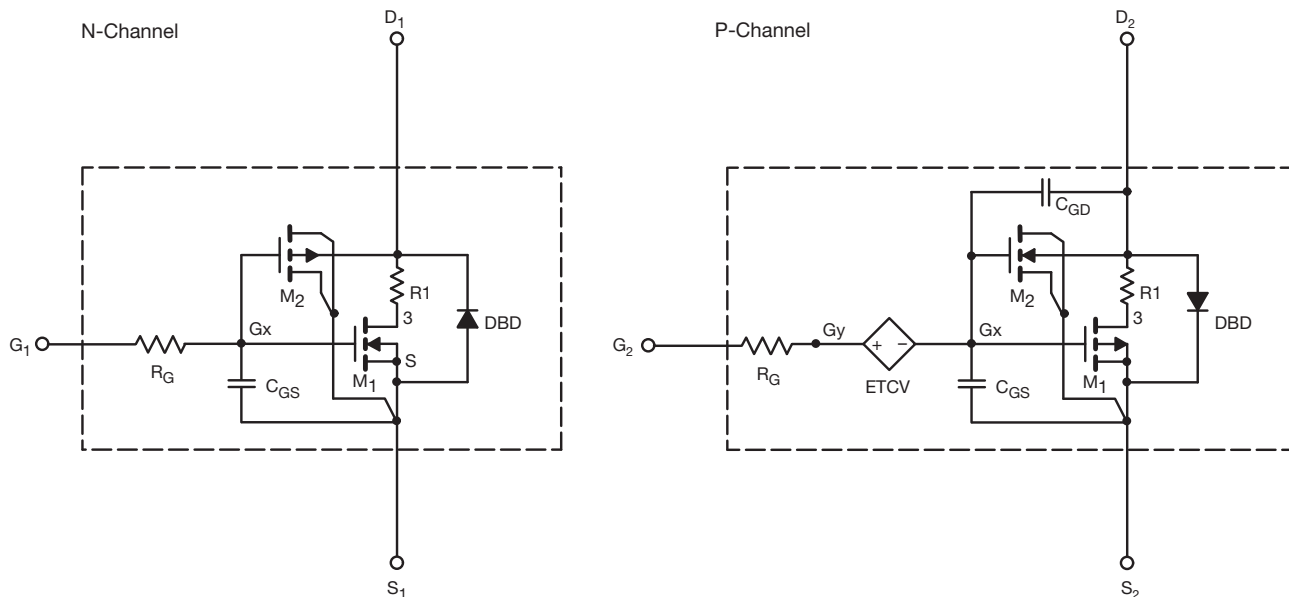

Note

- This document is intended as a SPICE modeling guideline and does not constitute a commercial product datasheet. Designers should refer to the appropriate datasheet of the same number for guaranteed specification limits.



SPECIFICATIONS (T _J = 25 °C, unless otherwise noted)						
PARAMETER	SYMBOL	TEST CONDITIONS		SIMULATED DATA	MEASURED DATA	UNIT
Static						
Gate-Source Threshold Voltage	V _{GS(th)}	V _{DS} = V _{GS} , I _D = 250 μA	N-Ch	2.2	-	V
		V _{DS} = V _{GS} , I _D = - 250 μA	P-Ch	2.4	-	
Drain-Source On-State Resistance ^a	R _{DS(on)}	V _{GS} = 10 V, I _D = 4.9 A	N-Ch	0.048	0.046	Ω
		V _{GS} = - 10 V, I _D = - 3.5 A	P-Ch	0.056	0.056	
		V _{GS} = 4.5 V, I _D = 4.1 A	N-Ch	0.084	0.083	
		V _{GS} = - 4.5 V, I _D = - 2.5 A	P-Ch	0.154	0.157	
Forward Transconductance ^a	g _{fs}	V _{DS} = 15 V, I _D = 4.9 A	N-Ch	9	9.8	S
		V _{DS} = - 15 V, I _D = - 3.5 A	P-Ch	7	5.5	
Diode Forward Voltage ^a	V _{SD}	I _S = 2 A, V _{GS} = 0 V	N-Ch	0.80	0.80	V
		I _S = - 1.5 A, V _{GS} = 0 V	P-Ch	- 0.81	- 0.80	
Dynamic^b						
Input Capacitance	C _{iss}	N-Channel V _{DS} = 25 V, V _{GS} = 0 V, f = 1 MHz P-Channel V _{DS} = - 25 V, V _{GS} = 0 V, f = 1 MHz	N-Ch	452	444	pF
			P-Ch	385	384	
Output Capacitance	C _{oss}		N-Ch	93	96	
			P-Ch	96	100	
Reverse Transfer Capacitance	C _{rss}		N-Ch	35	36	
			P-Ch	53	56	
Total Gate Charge	Q _g	N-Channel V _{DS} = 15 V, V _{GS} = 10 V, I _D = 3.9 A P-Channel V _{DS} = - 15 V, V _{GS} = - 10 V, I _D = - 2.5 A	N-Ch	7	8.7	nC
			P-Ch	8	9.7	
Gate-Source Charge	Q _{gs}		N-Ch	1.9	1.9	
			P-Ch	1.8	1.8	
Gate-Drain Charge	Q _{gd}		N-Ch	1.6	1.6	
			P-Ch	2.3	2.3	

Notes

- a. Pulse test; pulse width ≤ 300 μs, duty cycle ≤ 2 %.
- b. Guaranteed by design, not subject to production testing.



COMPARISON OF MODEL WITH MEASURED DATA ($T_J = 25\text{ }^\circ\text{C}$, unless otherwise noted)

N-Channel MOSFET

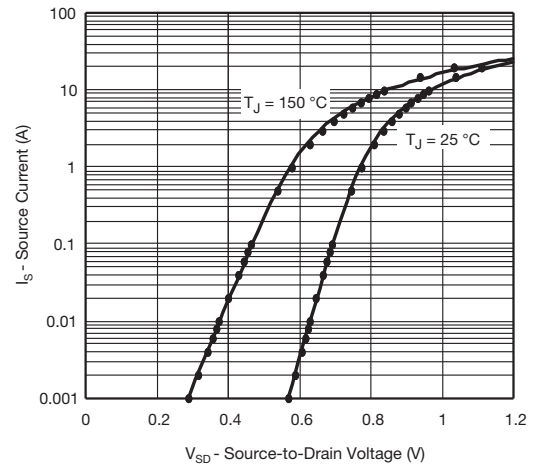
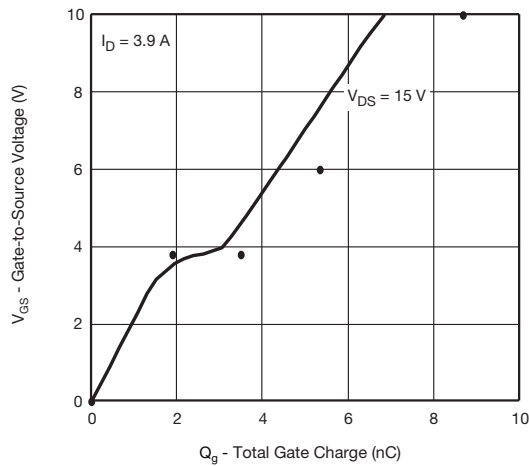
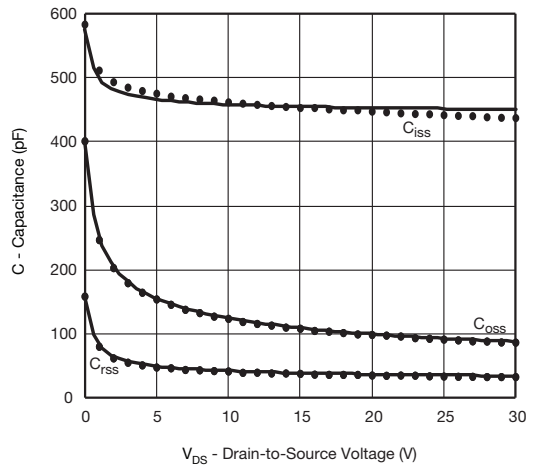
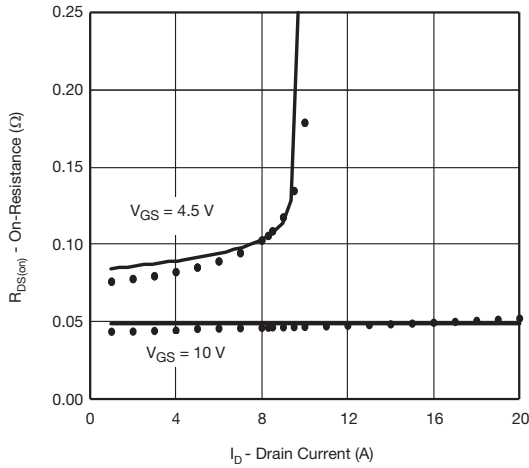
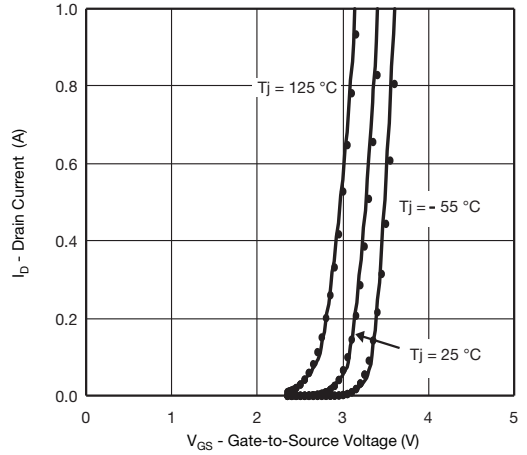
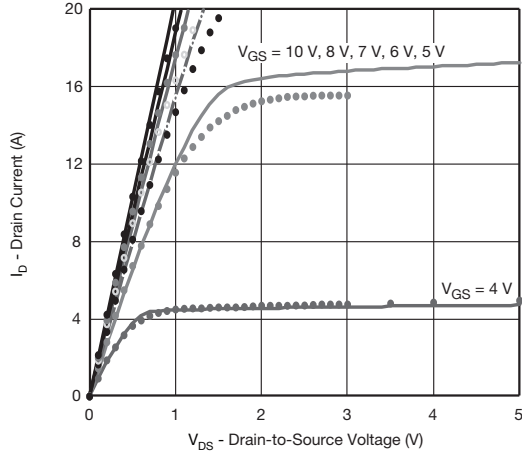

Note

- Dots and squares represent measured data.



COMPARISON OF MODEL WITH MEASURED DATA ($T_J = 25\text{ }^\circ\text{C}$, unless otherwise noted)

P-Channel MOSFET

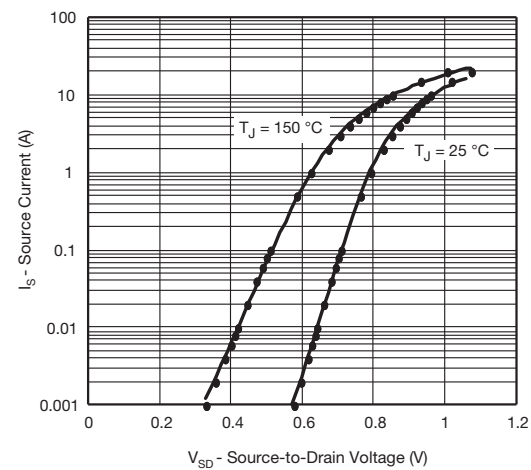
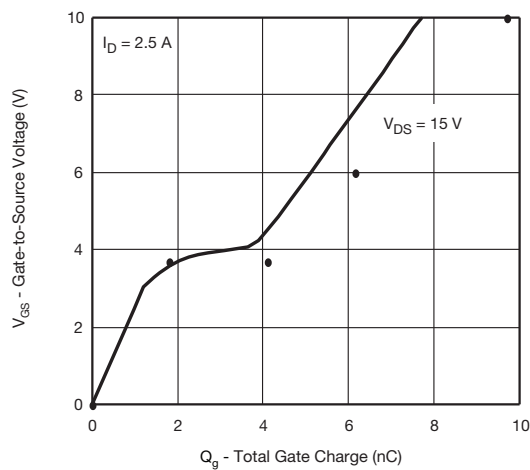
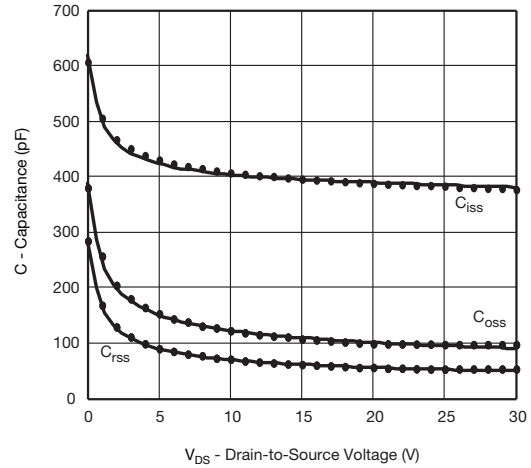
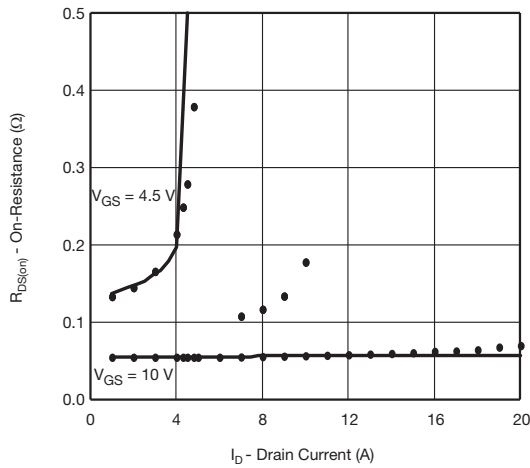
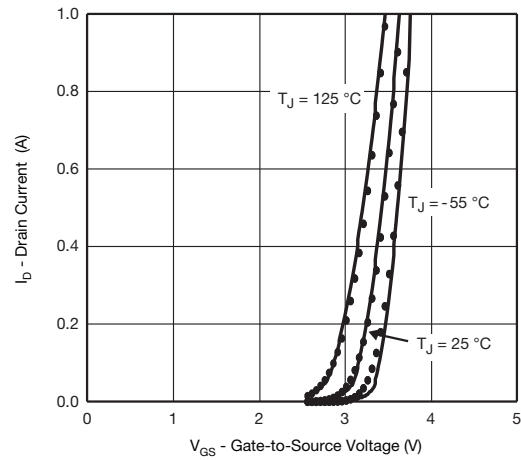
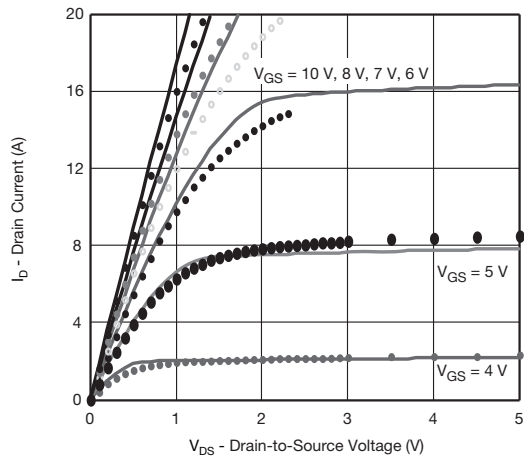

Note

- Dots and squares represent measured data.



Disclaimer

ALL PRODUCT, PRODUCT SPECIFICATIONS AND DATA ARE SUBJECT TO CHANGE WITHOUT NOTICE TO IMPROVE RELIABILITY, FUNCTION OR DESIGN OR OTHERWISE.

Vishay Intertechnology, Inc., its affiliates, agents, and employees, and all persons acting on its or their behalf (collectively, "Vishay"), disclaim any and all liability for any errors, inaccuracies or incompleteness contained in any datasheet or in any other disclosure relating to any product.

Vishay makes no warranty, representation or guarantee regarding the suitability of the products for any particular purpose or the continuing production of any product. To the maximum extent permitted by applicable law, Vishay disclaims (i) any and all liability arising out of the application or use of any product, (ii) any and all liability, including without limitation special, consequential or incidental damages, and (iii) any and all implied warranties, including warranties of fitness for particular purpose, non-infringement and merchantability.

Statements regarding the suitability of products for certain types of applications are based on Vishay's knowledge of typical requirements that are often placed on Vishay products in generic applications. Such statements are not binding statements about the suitability of products for a particular application. It is the customer's responsibility to validate that a particular product with the properties described in the product specification is suitable for use in a particular application. Parameters provided in datasheets and/or specifications may vary in different applications and performance may vary over time. All operating parameters, including typical parameters, must be validated for each customer application by the customer's technical experts. Product specifications do not expand or otherwise modify Vishay's terms and conditions of purchase, including but not limited to the warranty expressed therein.

Except as expressly indicated in writing, Vishay products are not designed for use in medical, life-saving, or life-sustaining applications or for any other application in which the failure of the Vishay product could result in personal injury or death. Customers using or selling Vishay products not expressly indicated for use in such applications do so at their own risk and agree to fully indemnify and hold Vishay and its distributors harmless from and against any and all claims, liabilities, expenses and damages arising or resulting in connection with such use or sale, including attorneys fees, even if such claim alleges that Vishay or its distributor was negligent regarding the design or manufacture of the part. Please contact authorized Vishay personnel to obtain written terms and conditions regarding products designed for such applications.

No license, express or implied, by estoppel or otherwise, to any intellectual property rights is granted by this document or by any conduct of Vishay. Product names and markings noted herein may be trademarks of their respective owners.

Material Category Policy

Vishay Intertechnology, Inc. hereby certifies that all its products that are identified as RoHS-Compliant fulfill the definitions and restrictions defined under Directive 2011/65/EU of The European Parliament and of the Council of June 8, 2011 on the restriction of the use of certain hazardous substances in electrical and electronic equipment (EEE) - recast, unless otherwise specified as non-compliant.

Please note that some Vishay documentation may still make reference to RoHS Directive 2002/95/EC. We confirm that all the products identified as being compliant to Directive 2002/95/EC conform to Directive 2011/65/EU.