

# High-Bandwidth, Low Voltage, Dual SPDT Analog Switches

## DESCRIPTION

The DG2016/DG2026 are monolithic CMOS dual single-pole/double-throw (SPDT) analog switches. They are specifically designed for low-voltage, high bandwidth applications.

The DG2016/DG2026's on-resistance ( $3 \Omega$  at 2.7 V), matching and flatness are guaranteed over the entire analog voltage range. Wide dynamic performance is achieved with better than -80 dB for both cross-talk and off-isolation at 1 MHz.

Both SPDT's operate with independent control logic, conduct equally well in both directions and block signals up to the power supply level when off. Break-before-make is guaranteed.

With fast switching speeds, low on-resistance, high bandwidth, and low charge injection, the DG2016/DG2026 are ideally suited for audio and video switching with high linearity.

Built on Vishay Siliconix's low voltage CMOS technology, the DG2016/DG2026 contain an epitaxial layer which prevents latch-up

## FEATURES

- Halogen-free according to IEC 61249-2-21 Definition
- Single Supply (1.8 V to 5.5 V)
- Low On-Resistance -  $R_{ON}$ :  $2.4 \Omega$
- Crosstalk and Off Isolation: -81 dB at 1 MHz
- MSOP-10 Package
- Compliant to RoHS Directive 2002/95/EC



**RoHS**  
COMPLIANT  
HALOGEN  
**FREE**

## BENEFITS

- Reduced Power Consumption
- High Accuracy
- Reduce Board Space
- Low-Voltage Logic Compatible
- High Bandwidth

## APPLICATIONS

- Cellular Phones
- Speaker Headset Switching
- Audio and Video Signal Routing
- PCMCIA Cards
- Low-Voltage Data Acquisition
- ATE

## FUNCTIONAL BLOCK DIAGRAM AND PIN CONFIGURATION

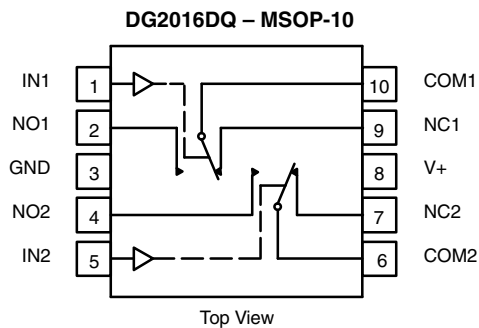

TRUTH TABLE		
Logic	NC1 and NC2	NO1 and NO2
0	ON	OFF
1	OFF	ON

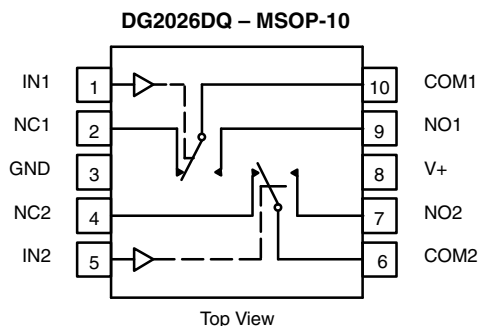

ORDERING INFORMATION		
Temp Range	Package	Part Number
-40 °C to 85 °C	MSOP-10	DG2016DQ-T1-E3
		DG2026DQ-T1-E3

ABSOLUTE MAXIMUM RATINGS			
Parameter		Limit	Unit
Reference V+ to GND		- 0.3 to + 6	V
IN, COM, NC, NO <sup>a</sup>		- 0.3 to (V+ + 0.3)	
Continuous Current (Any terminal)		± 50	mA
Peak Current (Pulsed at 1 ms, 10 % duty cycle)		± 200	
Storage Temperature (D Suffix)		- 65 to 150	°C
Power Dissipation (Packages) <sup>b</sup>	MSOP-10 <sup>c</sup>	320	mW

Notes:

a. Signals on NC, NO, or COM or IN exceeding V+ will be clamped by internal diodes. Limit forward diode current to maximum current ratings.

b. All leads welded or soldered to PC Board.

c. Derate 4 mW/°C above 70 °C.

SPECIFICATIONS (V+ = 3 V)							
Parameter	Symbol	Test Conditions Otherwise Unless Specified V+ = 3 V, ± 10 %, V <sub>IN</sub> = 0.4 V or 2 V <sup>e</sup>	Temp. <sup>a</sup>	Limits - 40 °C to 85 °C			Unit
				Min. <sup>b</sup>	Typ. <sup>c</sup>	Max. <sup>b</sup>	
<b>Analog Switch</b>							
Analog Signal Range <sup>d</sup>	V <sub>NO</sub> , V <sub>NC</sub> V <sub>COM</sub>		Full	0		V+	V
On-Resistance	R <sub>ON</sub>	V+ = 2.7 V, V <sub>COM</sub> = 0.2 V/1.5 V, I <sub>NO</sub> , I <sub>NC</sub> = 10 mA	Room Full		3	4.8 5.3	Ω
R <sub>ON</sub> Flatness	R <sub>ON</sub> Flatness	V+ = 2.7 V, V <sub>COM</sub> = 0 to V+, I <sub>NO</sub> , I <sub>NC</sub> = 10 mA	Room			1.6	
Switch Off Leakage Current <sup>f</sup>	I <sub>NO(off)</sub> I <sub>NC(off)</sub>	V+ = 3.3 V V <sub>NO</sub> , V <sub>NC</sub> = 0.3 V/3 V, V <sub>COM</sub> = 3 V/0.3 V	Room Full	- 1 - 10		1 10	nA
	I <sub>COM(off)</sub>		Room Full	- 1 - 10		1 10	
Channel-On Leakage Current <sup>f</sup>	I <sub>COM(on)</sub>	V+ = 3.3 V, V <sub>NO</sub> , V <sub>NC</sub> = V <sub>COM</sub> = 0.3 V/3 V	Room Full	- 1 - 10		1 10	
<b>Digital Control</b>							
Input High Voltage <sup>d</sup>	V <sub>INH</sub>		Full	1.6			V
Input Low Voltage	V <sub>INL</sub>		Full			0.4	
Input Capacitance	C <sub>in</sub>		Full		5		pF
Input Current	I <sub>INL</sub> or I <sub>INH</sub>	V <sub>IN</sub> = 0 V or V+	Full	1		1	μA
<b>Dynamic Characteristics</b>							
Turn-On Time	t <sub>ON</sub>	V <sub>NO</sub> or V <sub>NC</sub> = 2 V, R <sub>L</sub> = 50 Ω, C <sub>L</sub> = 35 pF	Room Full		28	53 59	ns
Turn-Off Time	t <sub>OFF</sub>		Room Full		13	38 38	
Break-Before-Make Time	t <sub>d</sub>		Full	1			
Charge Injection <sup>d</sup>	Q <sub>INJ</sub>	C <sub>L</sub> = 1 nF, V <sub>GEN</sub> = 0 V, R <sub>GEN</sub> = 0 Ω	Room		38		pC
Off-Isolation <sup>d</sup>	OIRR	R <sub>L</sub> = 50 Ω, C <sub>L</sub> = 5 pF, f = 1 MHz	Room		- 78		dB
Crosstalk <sup>d</sup>	X <sub>TALK</sub>		Room		- 82		
N <sub>O</sub> , N <sub>C</sub> Off Capacitance <sup>d</sup>	C <sub>NO(off)</sub>	V <sub>IN</sub> = 0 V or V+, f = 1 MHz	Room		15		pF
	C <sub>NC(off)</sub>		Room		15		
Channel-On Capacitance <sup>d</sup>	C <sub>NO(on)</sub>		Room		49		
	C <sub>NC(on)</sub>		Room		45		
<b>Power Supply</b>							
Power Supply Current	I+	V <sub>IN</sub> = 0 V or V+	Full		0.01	1	μA



SPECIFICATIONS (V+ = 5 V)							
Parameter	Symbol	Test Conditions Otherwise Unless Specified V+ = 5 V, ± 10 %, VIN = 0.8 V or 2.4 V <sup>e</sup>	Temp. <sup>a</sup>	Limits - 40 °C to 85 °C			Unit
				Min. <sup>b</sup>	Typ. <sup>c</sup>	Max. <sup>b</sup>	
<b>Analog Switch</b>							
Analog Signal Range <sup>d</sup>	V <sub>NO</sub> , V <sub>NC</sub> V <sub>COM</sub>		Full	0		V+	V
On-Resistance	R <sub>ON</sub>	V+ = 4.5 V, V <sub>COM</sub> = 3 V, I <sub>NO</sub> , I <sub>NC</sub> = 10 mA	Room Full		2.4	4 4.3	Ω
R <sub>ON</sub> Flatness	R <sub>ON</sub> Flatness	V+ = 4.5 V, V <sub>COM</sub> = 0 to V+, I <sub>NO</sub> , I <sub>NC</sub> = 10 mA	Room			1.2	
Switch Off Leakage Current	I <sub>NO(off)</sub> I <sub>NC(off)</sub>	V+ = 5.5 V V <sub>NO</sub> , V <sub>NC</sub> = 1 V/4.5 V, V <sub>COM</sub> = 4.5 V/1 V	Room Full	- 1 - 10		1 10	nA
	I <sub>COM(off)</sub>		Room Full	- 1 - 10		1 10	
Channel-On Leakage Current	I <sub>COM(on)</sub>	V+ = 5.5 V, V <sub>NO</sub> , V <sub>NC</sub> = V <sub>COM</sub> = 1 V/4.5 V	Room Full	- 1 - 10		1 10	
<b>Digital Control</b>							
Input High Voltage <sup>d</sup>	V <sub>INH</sub>		Full	2			V
Input Low Voltage	V <sub>INL</sub>		Full			0.8	
Input Capacitance	C <sub>in</sub>		Full		5		pF
Input Current	I <sub>INL</sub> or I <sub>INH</sub>	V <sub>IN</sub> = 0 V or V+	Full	1		1	μA
<b>Dynamic Characteristics</b>							
Turn-On Time	t <sub>ON</sub>	V <sub>NO</sub> or V <sub>NC</sub> = 3 V, R <sub>L</sub> = 50 Ω, C <sub>L</sub> = 35 pF	Room Full		23	48 52	ns
Turn-Off Time	t <sub>OFF</sub>		Room Full		8	33 35	
Break-Before-Make Time	t <sub>d</sub>		Full	1			
Charge Injection <sup>d</sup>	Q <sub>INJ</sub>	C <sub>L</sub> = 1 nF, V <sub>GEN</sub> = 0 V, R <sub>GEN</sub> = 0 Ω	Room		79		pC
Off-Isolation <sup>d</sup>	OIRR	R <sub>L</sub> = 50 Ω, C <sub>L</sub> = 5 pF, f = 1 MHz	Room		- 81		dB
Crosstalk <sup>d</sup>	X <sub>TALK</sub>		Room		- 82		
Source-Off Capacitance <sup>d</sup>	C <sub>NO(off)</sub>	V <sub>IN</sub> = 0 V or V+, f = 1 MHz	Room		14		pF
	C <sub>NC(off)</sub>		Room		14		
Channel-On Capacitance <sup>d</sup>	C <sub>NO(on)</sub>		Room		48		
	C <sub>NC(on)</sub>		Room		44		
<b>Power Supply</b>							
Power Supply Range	V+			1.8		5.5	V
Power Supply Current	I+	V <sub>IN</sub> = 0 V or V+	Full		0.01	1	μA

Notes:

- a. Room = 25 °C, Full = as determined by the operating suffix.
- b. Typical values are for design aid only, not guaranteed nor subject to production testing.
- c. The algebraic convention whereby the most negative value is a minimum and the most positive a maximum, is used in this data sheet.
- d. Guarantee by design, nor subjected to production test.
- e. V<sub>IN</sub> = input voltage to perform proper function.
- f. Guaranteed by 5 V leakage testing, not production tested.

Stresses beyond those listed under "Absolute Maximum Ratings" may cause permanent damage to the device. These are stress ratings only, and functional operation of the device at these or any other conditions beyond those indicated in the operational sections of the specifications is not implied. Exposure to absolute maximum rating conditions for extended periods may affect device reliability.

**TYPICAL CHARACTERISTICS** (25 °C, unless otherwise noted)

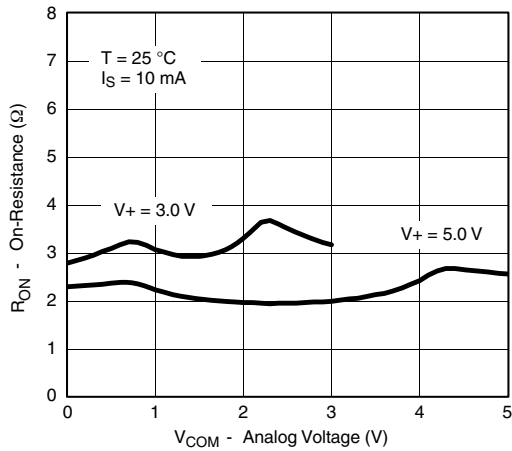

**$R_{ON}$  vs.  $V_{COM}$  and Supply Voltage**

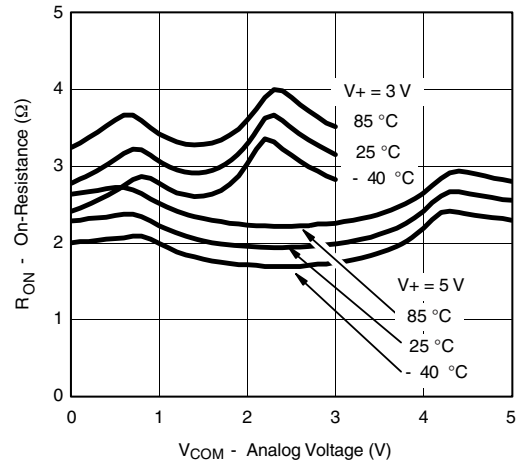

**$R_{ON}$  vs. Analog Voltage and Temperature**

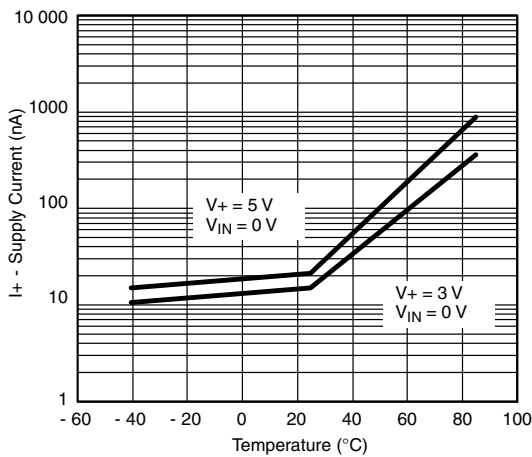

**Supply Current vs. Temperature**

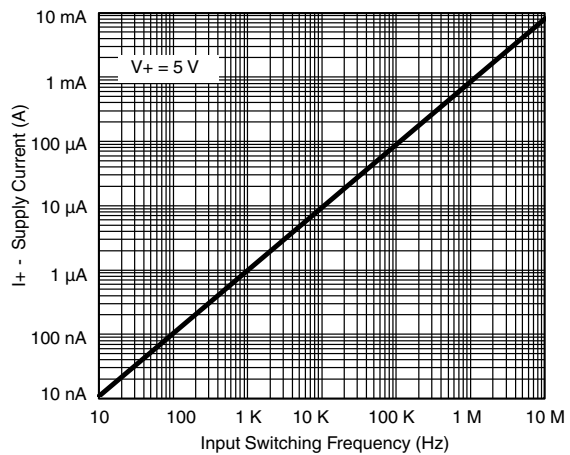

**Supply Current vs. Input Switching Frequency**

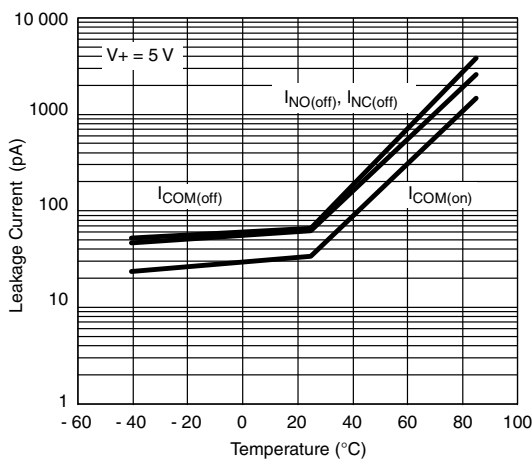

**Leakage Current vs. Temperature**

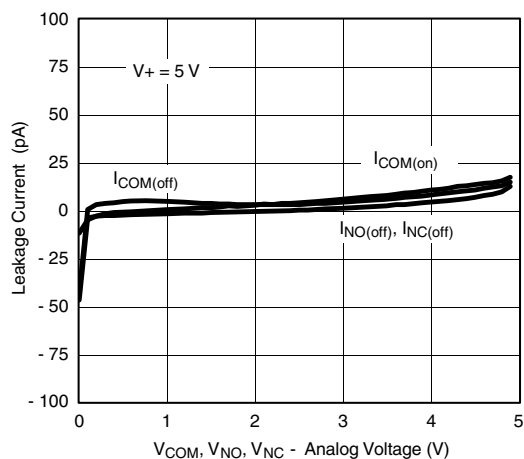

**Leakage vs. Analog Voltage**

**TYPICAL CHARACTERISTICS** (25 °C, unless otherwise noted)

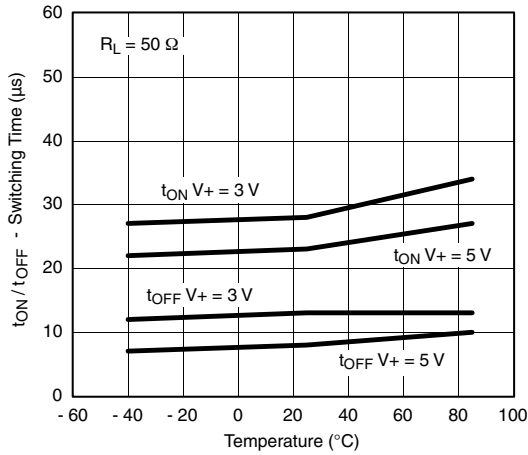

**Switching Time vs. Temperature**

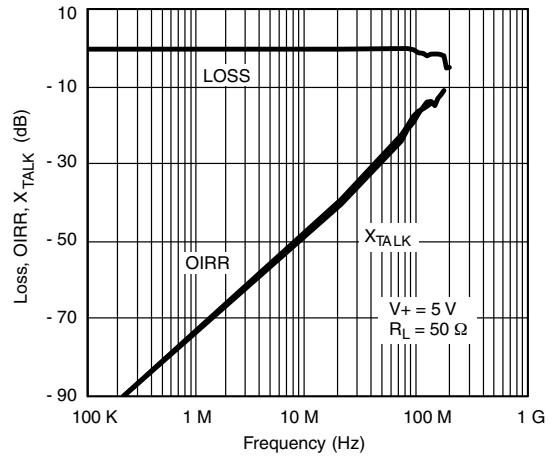

**Insertion Loss, Off-Isolation Crosstalk vs. Frequency**

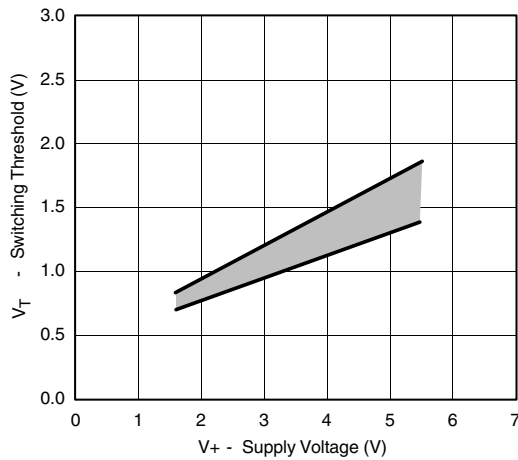

**Switching Threshold vs. Supply Voltage**

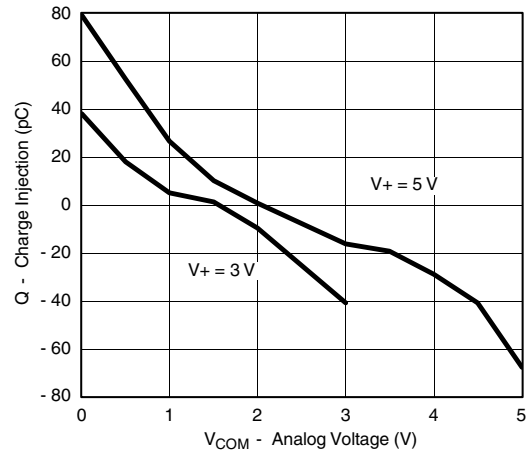

**Charge Injection vs. Analog Voltage**

**TEST CIRCUITS**

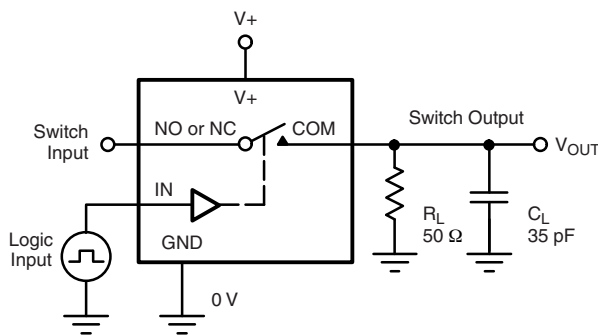

$C_L$  (includes fixture and stray capacitance)

$$V_{OUT} = V_{COM} \left( \frac{R_L}{R_L + R_{ON}} \right)$$

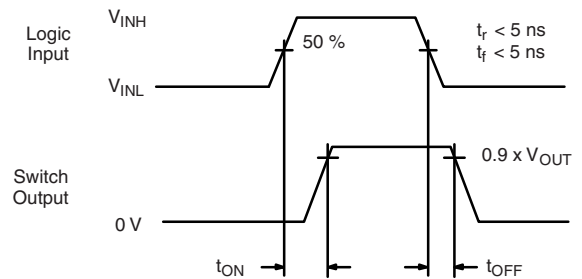

Logic "1" = Switch On  
Logic input waveforms inverted for switches that have the opposite logic sense.

**Figure 1. Switching Time**

TEST CIRCUITS

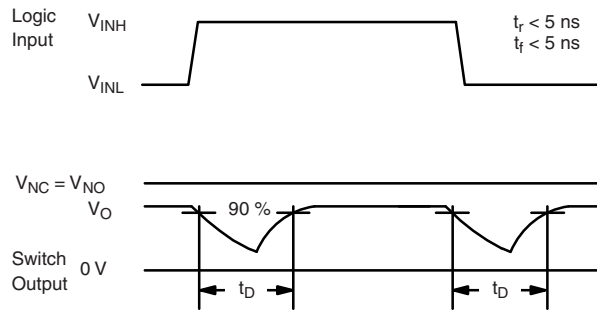
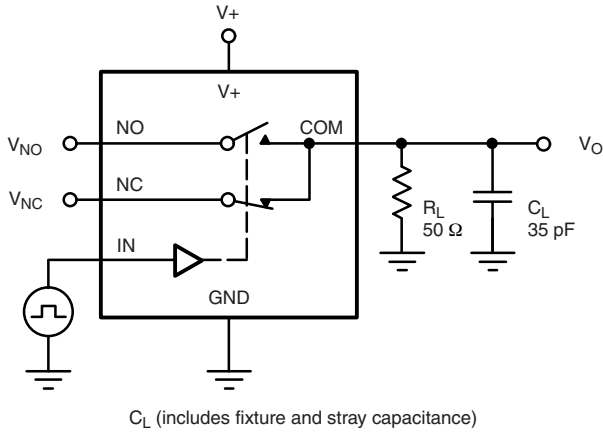
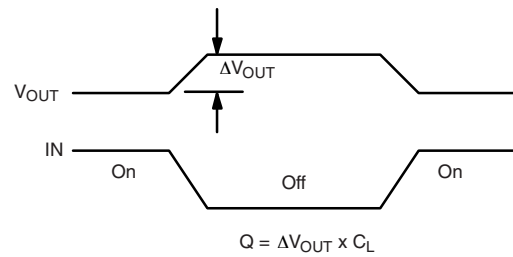
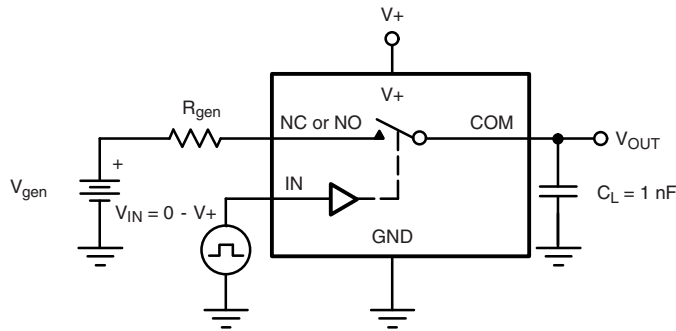

Figure 2. Break-Before-Make Interval



IN depends on switch configuration: input polarity determined by sense of switch.

Figure 3. Charge Injection

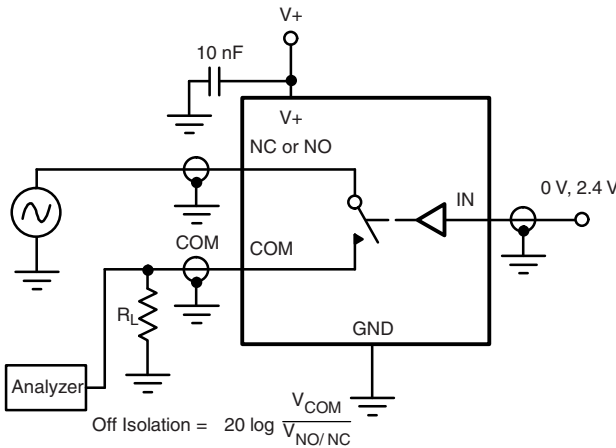

Figure 4. Off-Isolation

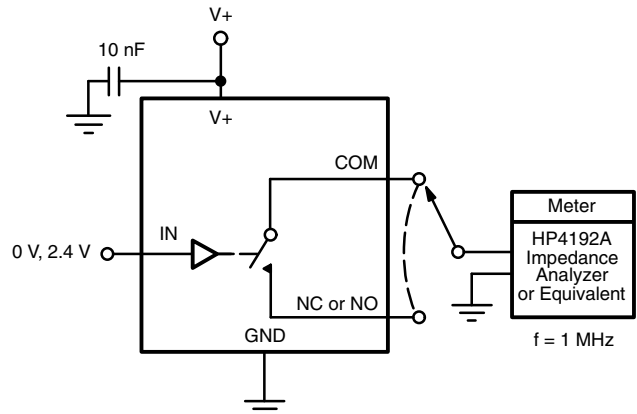

Figure 5. Channel Off/On Capacitance

Vishay Siliconix maintains worldwide manufacturing capability. Products may be manufactured at one of several qualified locations. Reliability data for Silicon Technology and Package Reliability represent a composite of all qualified locations. For related documents such as package/tape drawings, part marking, and reliability data, see [www.vishay.com/ppq?72030](http://www.vishay.com/ppq?72030).



**MSOP: 10-LEADS**

JEDEC Part Number: MO-187, (Variation AA and BA)

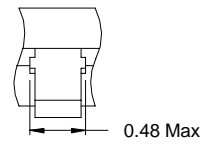
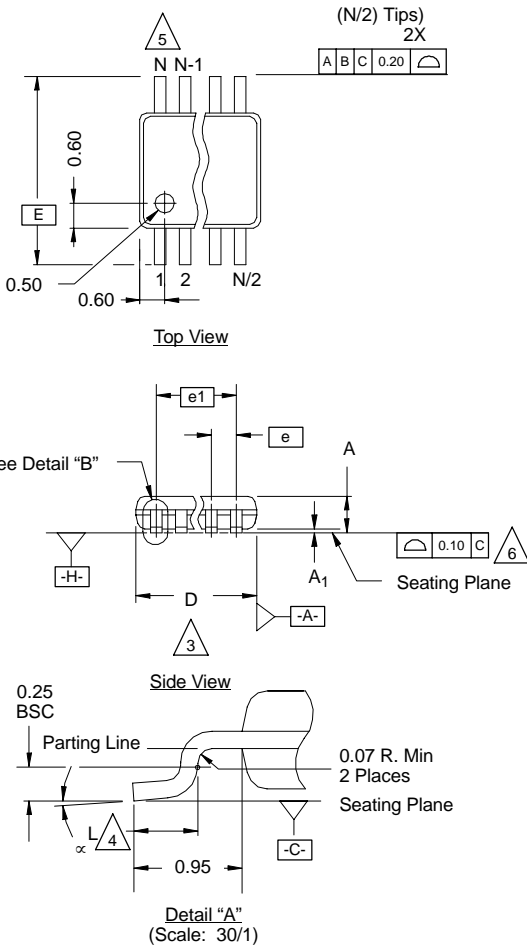

Detail "B"  
(Scale: 30/1)  
Dambar Protrusion

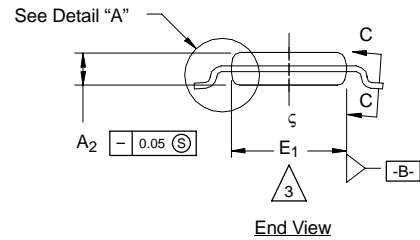
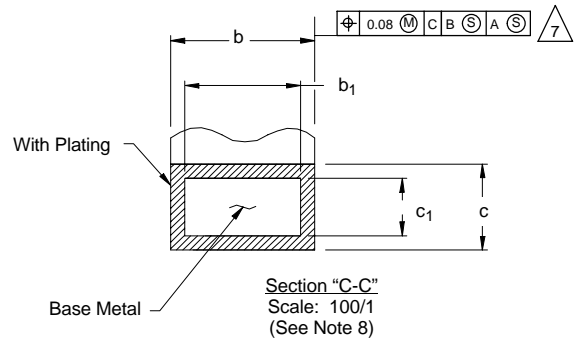

NOTES:

- Die thickness allowable is 0.203 ± 0.0127.
- Dimensioning and tolerances per ANSI.Y14.5M-1994.
- Dimensions "D" and "E<sub>1</sub>" do not include mold flash or protrusions, and are measured at Datum plane [-H-], mold flash or protrusions shall not exceed 0.15 mm per side.
- Dimension is the length of terminal for soldering to a substrate.
- Terminal positions are shown for reference only.
- Formed leads shall be planar with respect to one another within 0.10 mm at seating plane.
- The lead width dimension does not include Dambar protrusion. Allowable Dambar protrusion shall be 0.08 mm total in excess of the lead width dimension at maximum material condition. Dambar cannot be located on the lower radius or the lead foot. Minimum space between protrusions and an adjacent lead to be 0.14 mm. See detail "B" and Section "C-C".
- Section "C-C" to be determined at 0.10 mm to 0.25 mm from the lead tip.
- Controlling dimension: millimeters.
- This part is compliant with JEDEC registration MO-187, variation AA and BA.
- Datums [-A-] and [-B-] to be determined Datum plane [-H-].
- Exposed pad area in bottom side is the same as teh leadframe pad size.

**N = 10L**

Dim	MILLIMETERS			Note
	Min	Nom	Max	
A	-	-	1.10	
A <sub>1</sub>	0.05	0.10	0.15	
A <sub>2</sub>	0.75	0.85	0.95	
b	0.17	-	0.27	8
b <sub>1</sub>	0.17	0.20	0.23	8
c	0.13	-	0.23	
c <sub>1</sub>	0.13	0.15	0.18	
D	3.00 BSC			3
E	4.90 BSC			
E <sub>1</sub>	2.90	3.00	3.10	3
e	0.50 BSC			
e <sub>1</sub>	2.00 BSC			
L	0.40	0.55	0.70	4
N	10			5
α	0°	4°	6°	
ECN: T-02080—Rev. C, 15-Jul-02 DWG: 5867				



## Disclaimer

ALL PRODUCT, PRODUCT SPECIFICATIONS AND DATA ARE SUBJECT TO CHANGE WITHOUT NOTICE TO IMPROVE RELIABILITY, FUNCTION OR DESIGN OR OTHERWISE.

Vishay Intertechnology, Inc., its affiliates, agents, and employees, and all persons acting on its or their behalf (collectively, "Vishay"), disclaim any and all liability for any errors, inaccuracies or incompleteness contained in any datasheet or in any other disclosure relating to any product.

Vishay makes no warranty, representation or guarantee regarding the suitability of the products for any particular purpose or the continuing production of any product. To the maximum extent permitted by applicable law, Vishay disclaims (i) any and all liability arising out of the application or use of any product, (ii) any and all liability, including without limitation special, consequential or incidental damages, and (iii) any and all implied warranties, including warranties of fitness for particular purpose, non-infringement and merchantability.

Statements regarding the suitability of products for certain types of applications are based on Vishay's knowledge of typical requirements that are often placed on Vishay products in generic applications. Such statements are not binding statements about the suitability of products for a particular application. It is the customer's responsibility to validate that a particular product with the properties described in the product specification is suitable for use in a particular application. Parameters provided in datasheets and/or specifications may vary in different applications and performance may vary over time. All operating parameters, including typical parameters, must be validated for each customer application by the customer's technical experts. Product specifications do not expand or otherwise modify Vishay's terms and conditions of purchase, including but not limited to the warranty expressed therein.

Except as expressly indicated in writing, Vishay products are not designed for use in medical, life-saving, or life-sustaining applications or for any other application in which the failure of the Vishay product could result in personal injury or death. Customers using or selling Vishay products not expressly indicated for use in such applications do so at their own risk and agree to fully indemnify and hold Vishay and its distributors harmless from and against any and all claims, liabilities, expenses and damages arising or resulting in connection with such use or sale, including attorneys fees, even if such claim alleges that Vishay or its distributor was negligent regarding the design or manufacture of the part. Please contact authorized Vishay personnel to obtain written terms and conditions regarding products designed for such applications.

No license, express or implied, by estoppel or otherwise, to any intellectual property rights is granted by this document or by any conduct of Vishay. Product names and markings noted herein may be trademarks of their respective owners.

## Material Category Policy

**Vishay Intertechnology, Inc. hereby certifies that all its products that are identified as RoHS-Compliant fulfill the definitions and restrictions defined under Directive 2011/65/EU of The European Parliament and of the Council of June 8, 2011 on the restriction of the use of certain hazardous substances in electrical and electronic equipment (EEE) - recast, unless otherwise specified as non-compliant.**

**Please note that some Vishay documentation may still make reference to RoHS Directive 2002/95/EC. We confirm that all the products identified as being compliant to Directive 2002/95/EC conform to Directive 2011/65/EU.**