

Dual P-Channel 12 V (D-S) MOSFET

PRODUCT SUMMARY		
V _{DS} (V)	R _{DS(on)} (Ω)	I _D (A)
- 12	0.021 at V _{GS} = - 4.5 V	- 5.8
	0.028 at V _{GS} = - 2.5 V	- 5.0
	0.037 at V _{GS} = - 1.8 V	- 4.4

FEATURES

- TrenchFET[®] Power MOSFETs
- Material categorization:
For definitions of compliance please see www.vishay.com/doc?99912



RoHS
COMPLIANT
HALOGEN
FREE
Available

APPLICATIONS

- Load Switch
- Battery Switch

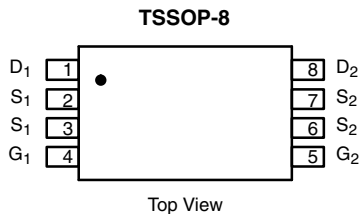

Ordering Information:
Si6913DQ-T1-E3 (Lead (Pb)-free)
Si6913DQ-T1-GE3 (Lead (Pb)-free and Halogen-free)

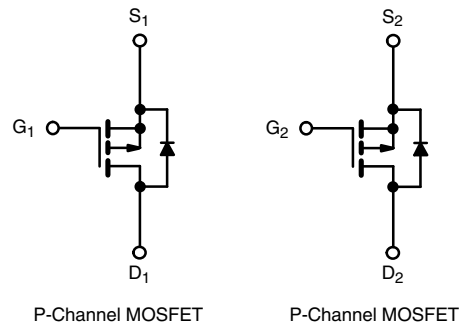

ABSOLUTE MAXIMUM RATINGS (T _A = 25 °C, unless otherwise noted)				
Parameter	Symbol	10 s	Steady State	Unit
Drain-Source Voltage	V _{DS}	- 12		V
Gate-Source Voltage	V _{GS}	± 8		
Continuous Drain Current (T _J = 150 °C) ^a	I _D	T _A = 25 °C	- 5.8	- 4.9
		T _A = 70 °C	- 4.6	- 3.9
Pulsed Drain Current (10 μs Pulse Width)	I _{DM}	- 30		A
Continuous Source Current (Diode Conduction) ^a	I _S	- 1	- 0.7	
Maximum Power Dissipation ^a	P _D	T _A = 25 °C	1.14	0.83
		T _A = 70 °C	0.73	0.53
Operating Junction and Storage Temperature Range	T _J , T _{stg}	- 55 to 150		°C

THERMAL RESISTANCE RATINGS					
Parameter		Symbol	Typical	Maximum	Unit
Maximum Junction-to-Ambient ^a	t ≤ 10 s	R _{thJA}	86	110	°C/W
	Steady State		124	150	
Maximum Junction-to-Foot (Drain)	Steady State	R _{thJF}	52	65	

Notes:

a. Surface mounted on 1" x 1" FR4 board.

SPECIFICATIONS ($T_J = 25\text{ }^\circ\text{C}$, unless otherwise noted)						
Parameter	Symbol	Test Conditions	Min.	Typ.	Max.	Unit
Static						
Gate Threshold Voltage	$V_{GS(th)}$	$V_{DS} = V_{GS}, I_D = -400\text{ }\mu\text{A}$	-0.4		-0.9	V
Gate-Body Leakage	I_{GSS}	$V_{DS} = 0\text{ V}, V_{GS} = \pm 8\text{ V}$			± 100	nA
Zero Gate Voltage Drain Current	I_{DSS}	$V_{DS} = -12\text{ V}, V_{GS} = 0\text{ V}$			-1	μA
		$V_{DS} = -12\text{ V}, V_{GS} = 0\text{ V}, T_J = 70\text{ }^\circ\text{C}$			-25	
On-State Drain Current ^a	$I_{D(on)}$	$V_{DS} = -5\text{ V}, V_{GS} = -4.5\text{ V}$	-20			A
Drain-Source On-State Resistance ^a	$R_{DS(on)}$	$V_{GS} = -4.5\text{ V}, I_D = -5.8\text{ A}$		0.016	0.021	Ω
		$V_{GS} = -2.5\text{ V}, I_D = -5\text{ A}$		0.021	0.028	
		$V_{GS} = -1.8\text{ V}, I_D = -4.4\text{ A}$		0.029	0.037	
Forward Transconductance ^a	g_{fs}	$V_{DS} = -5\text{ V}, I_D = -5.8\text{ A}$		25		S
Diode Forward Voltage ^a	V_{SD}	$I_S = -1\text{ A}, V_{GS} = 0\text{ V}$		-0.61	-1.1	V
Dynamic^b						
Total Gate Charge	Q_g	$V_{DS} = -6\text{ V}, V_{GS} = -4.5\text{ V}, I_D = -5.8\text{ A}$		18.5	28	nC
Gate-Source Charge	Q_{gs}		2.7			
Gate-Drain Charge	Q_{gd}		5			
Gate Resistance	R_g	$f = 1\text{ MHz}$		4.6		Ω
Turn-On Delay Time	$t_{d(on)}$	$V_{DD} = -6\text{ V}, R_L = 6\text{ }\Omega$ $I_D \cong -1\text{ A}, V_{GEN} = -4.5\text{ V}, R_G = 6\text{ }\Omega$		45	70	ns
Rise Time	t_r		80	120		
Turn-Off Delay Time	$t_{d(off)}$		130	200		
Fall Time	t_f		80	120		
Source-Drain Reverse Recovery Time	t_{rr}	$I_F = -1\text{ A}, dI/dt = 100\text{ A}/\mu\text{s}$		65	100	

Notes:

- a. Pulse test; pulse width $\leq 300\text{ }\mu\text{s}$, duty cycle $\leq 2\%$.
- b. Guaranteed by design, not subject to production testing.

Stresses beyond those listed under "Absolute Maximum Ratings" may cause permanent damage to the device. These are stress ratings only, and functional operation of the device at these or any other conditions beyond those indicated in the operational sections of the specifications is not implied. Exposure to absolute maximum rating conditions for extended periods may affect device reliability.

TYPICAL CHARACTERISTICS (25 °C, unless otherwise noted)

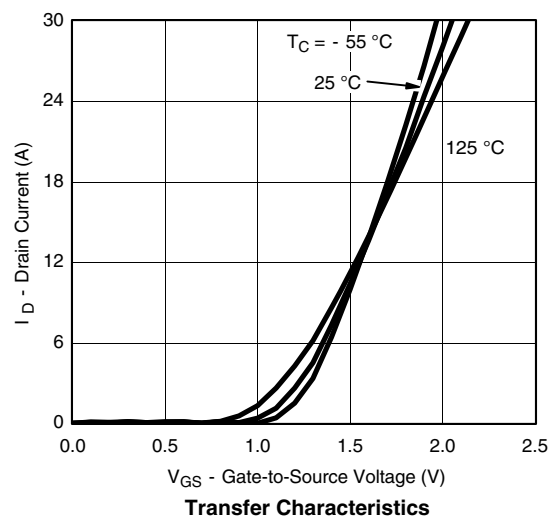
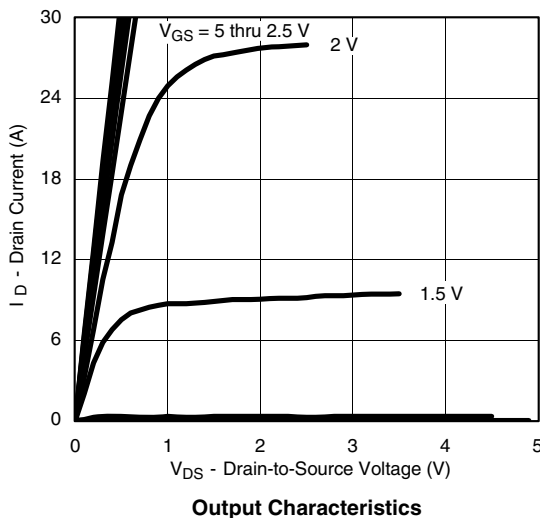

TYPICAL CHARACTERISTICS (25 °C, unless otherwise noted)

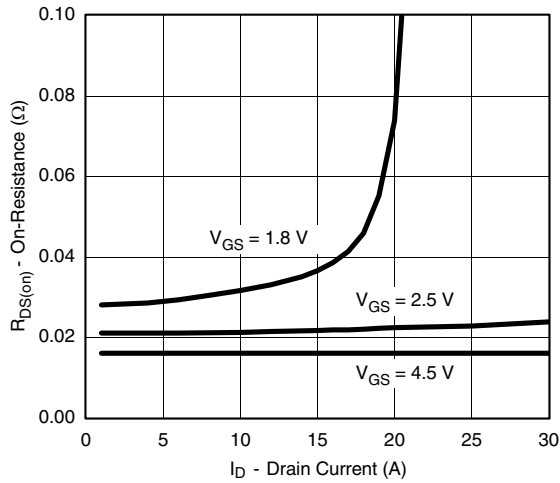

On-Resistance vs. Drain Current

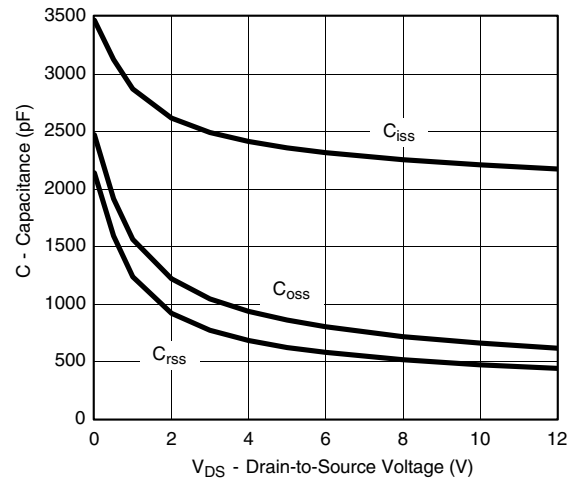

Capacitance

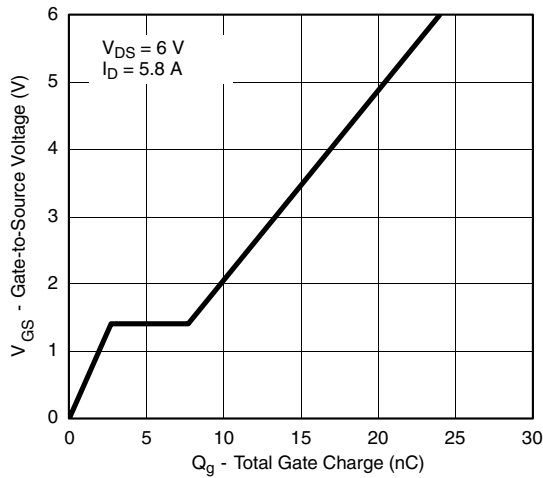

Gate Charge

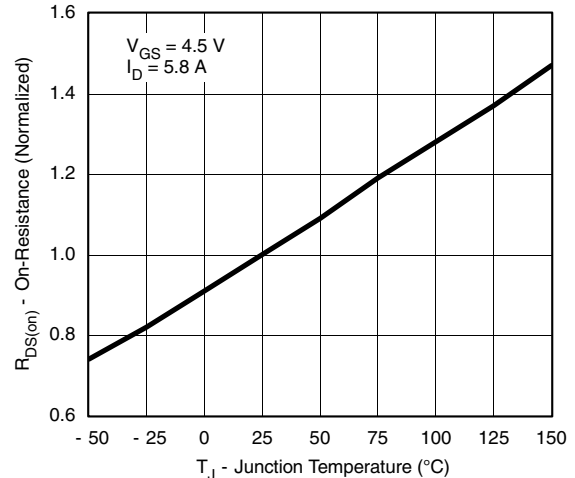

On-Resistance vs. Junction Temperature

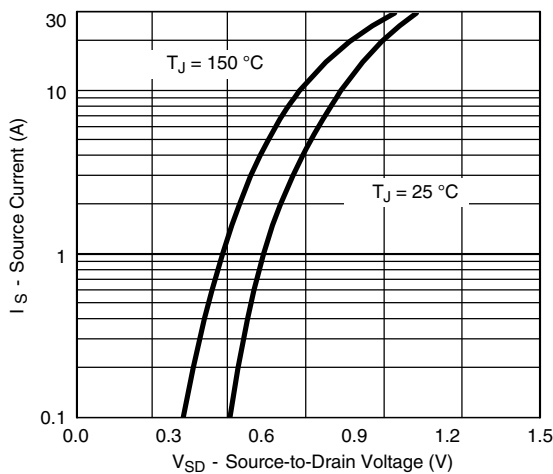

Source-Drain Diode Forward Voltage

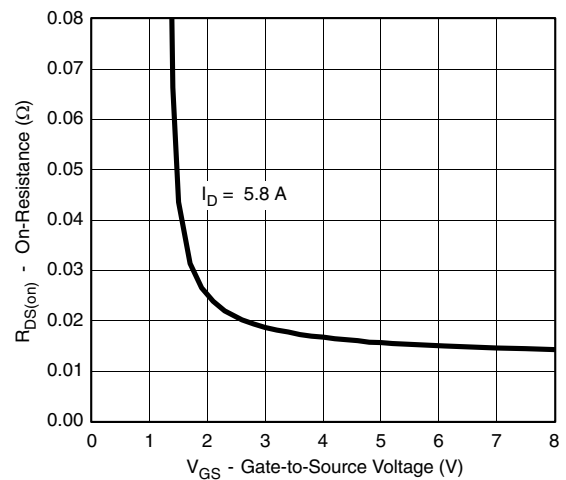

On-Resistance vs. Gate-to-Source Voltage

TYPICAL CHARACTERISTICS (25 °C, unless otherwise noted)

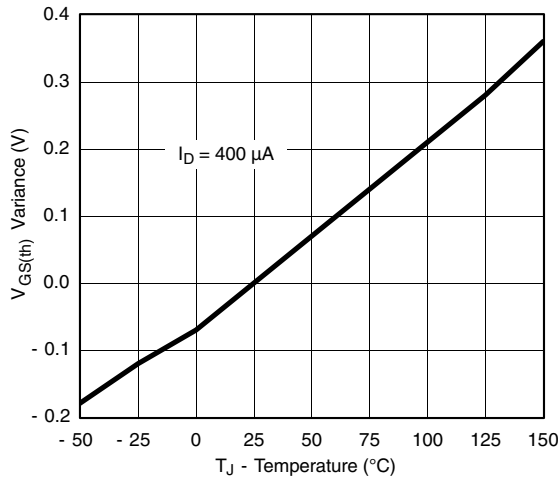

Threshold Voltage

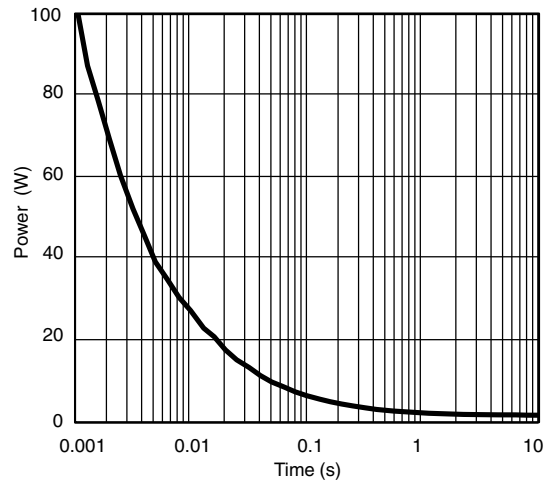

Single Pulse Power, Junction-to-Ambient

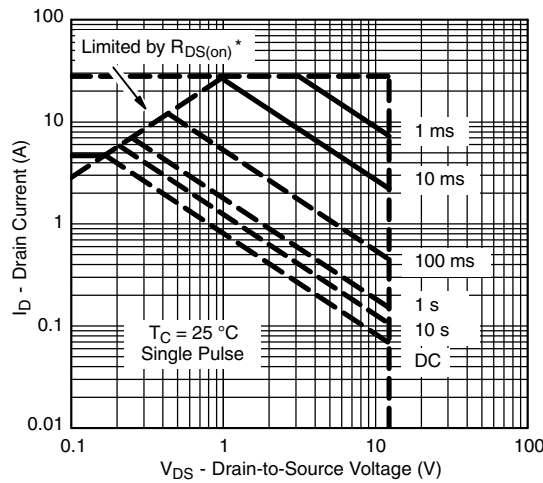

Safe Operating Area, Junction-to-Case

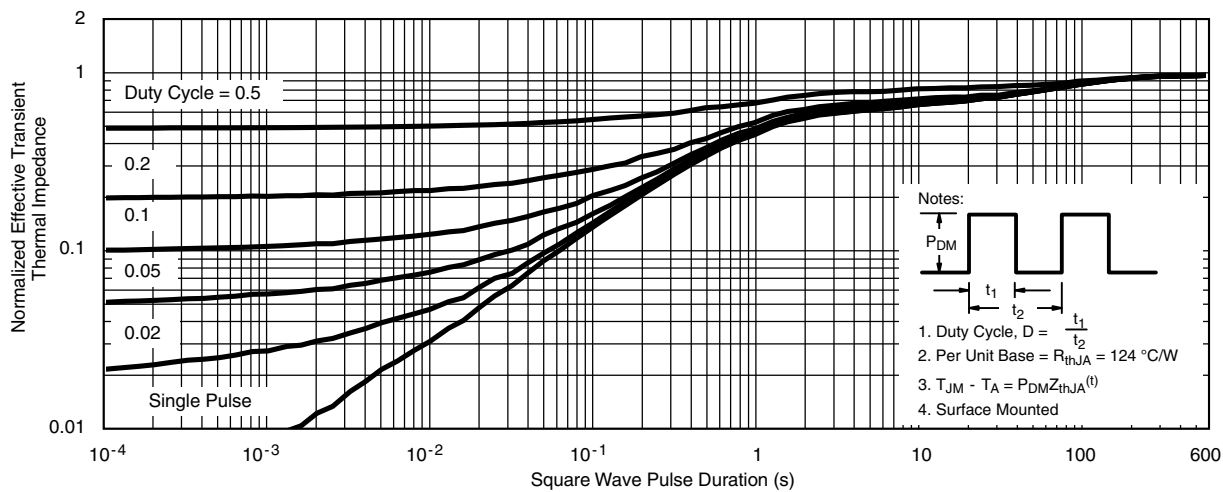

Normalized Thermal Transient Impedance, Junction-to-Ambient

Notes:

 1. Duty Cycle, $D = \frac{t_1}{t_2}$
 2. Per Unit Base = $R_{thJA} = 124 \text{ }^\circ\text{C/W}$
 3. $T_{JM} - T_A = P_{DM} Z_{thJA}^{(t)}$
 4. Surface Mounted

TYPICAL CHARACTERISTICS (25 °C, unless otherwise noted)

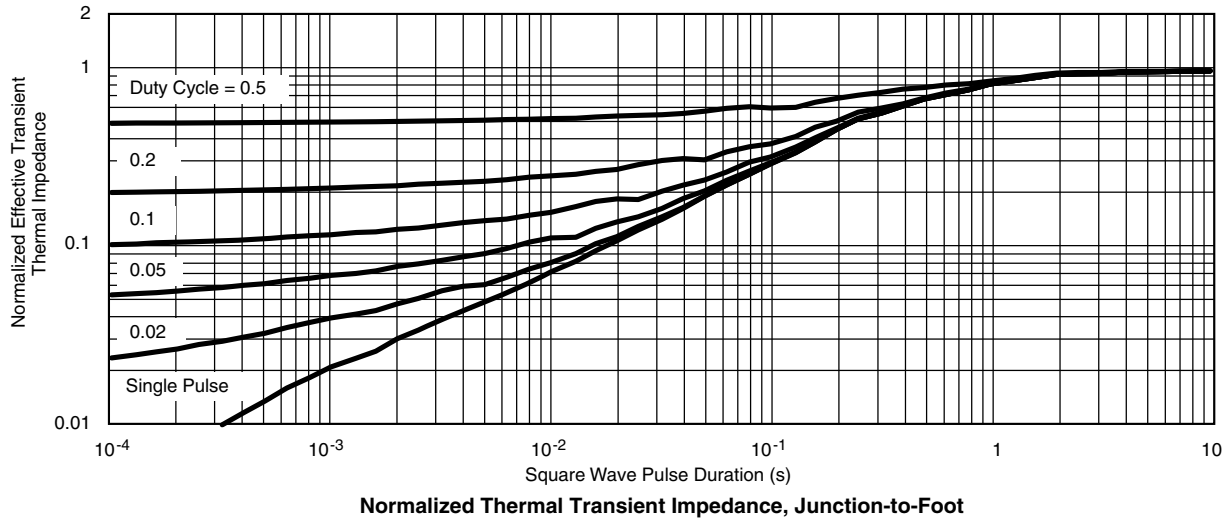

Vishay Siliconix maintains worldwide manufacturing capability. Products may be manufactured at one of several qualified locations. Reliability data for Silicon Technology and Package Reliability represent a composite of all qualified locations. For related documents such as package/tape drawings, part marking, and reliability data, see www.vishay.com/ppg?72368.



TSSOP: 8-LEAD

JEDEC Part Number: MO-153



Dim	MILLIMETERS		
	Min	Nom	Max
A	–	–	1.20
A ₁	0.05	0.10	0.15
A ₂	0.80	1.00	1.05
B	0.19	0.28	0.30
C	–	0.127	–
D	2.90	3.00	3.10
E	6.20	6.40	6.60
E ₁	4.30	4.40	4.50
e	–	0.65	–
L	0.45	0.60	0.75
L ₁	0.90	1.00	1.10
Y	–	–	0.10
£K1	0°	3°	6°

ECN: S-03946—Rev. G, 09-Jul-01
DWG: 5844

LITTLE FOOT® TSSOP-8

The Next Step in Surface-Mount Power MOSFETs

Wharton McDaniel and David Oldham

When Vishay Siliconix introduced its LITTLE FOOT MOSFETs, it was the first time that power MOSFETs had been offered in a true surface-mount package, the SOIC. LITTLE FOOT immediately found a home in new small form factor disk drives, computers, and cellular phones.

The new LITTLE FOOT TSSOP-8 power MOSFETs are the natural evolutionary response to the continuing demands of many markets for smaller and smaller packages. LITTLE FOOT TSSOP-8 MOSFETs have a smaller footprint and a lower profile than LITTLE FOOT SOICs, while maintaining low $r_{DS(on)}$ and high thermal performance. Vishay Siliconix has accomplished this by putting one or two high-density MOSFET die in a standard 8-pin TSSOP package mounted on a custom leadframe.

THE TSSOP-8 PACKAGE

LITTLE FOOT TSSOP-8 power MOSFETs require approximately half the PC board area of an equivalent LITTLE FOOT device (Figure 1). In addition to the reduction in board area, the package height has been reduced to 1.1 mm.



Figure 1. An TSSOP-8 Package Next to a SOIC-8 Package with Views from Both Top and Side

This is the low profile demanded by applications such as PCMCIA cards.

It reduces the power package to the same height as many resistors and capacitors in 0805 and 0605 sizes. It also allows placement on the “passive” side of the PC board.

The standard pinouts of the LITTLE FOOT TSSOP-8 packages have been changed from the standard established by LITTLE FOOT. This change minimizes the contribution of interconnection resistance to $r_{DS(on)}$ and maximizes the transfer of heat out of the package.

Figure 2 shows the pinouts for a single-die TSSOP. Notice that both sides of the package have Source and Drain connections, whereas LITTLE FOOT has the Source and Gate connections on one side of the package, and the Drain connections are on the opposite side.



Figure 2. Pinouts for Single Die TSSOP

Figure 3 shows the standard pinouts for a dual-die TSSOP-8. In this case, the connections for each individual MOSFET occupy one side.



Figure 3. Pinouts for Dual-Die TSSOP

Because the TSSOP has a fine pitch foot print, the pad layout is somewhat more demanding than the layout of the SOIC. Careful attention must be paid to silkscreen-to-pad and soldermask-to-pad clearances. Also, fiducial marks may be required. The design and spacing of the pads must be dealt with carefully. The pads must be sized to hold enough solder paste to form a good joint, but should not be so large or so placed as to extend under the body, increasing the potential for solder bridging. The pad pattern should allow for typical pick and place errors of 0.25 mm. See Application Note 826, *Recommended Minimum Pad Patterns With Outline Drawing Access for Vishay Siliconix MOSFETs*, (<http://www.vishay.com/doc?72286>), for the recommended pad pattern for PC board layout.

THERMAL ISSUES

LITTLE FOOT TSSOP MOSFETs have been given thermal ratings using the same methods used for LITTLE FOOT. The maximum thermal resistance junction-to-ambient is 83°C/W for the single die and 125°C/W for dual-die parts. TSSOP relies on a leadframe similar to LITTLE FOOT to remove heat from the package. The single- and dual-die leadframes are shown in Figure 4.



Figure 4. Leadframe

The MOSFETs are characterized using a single pulse power test. For this test the device mounted on a one-square-inch piece of copper clad FR-4 PC board, such as those shown in Figure 5. The single pulse power test determines the maximum amount of power the part can handle for a given pulse width and defines the thermal resistance junction-to-ambient. The test is run for pulse widths ranging from approximately 10 ms to 100 seconds. The thermal resistance at 30 seconds is the rated thermal resistance for the part. This rating was chosen to allow comparison of packages and leadframes. At longer pulse widths, the PC board thermal characteristics become dominant, making all parts look the same.



Figure 5.

The actual test is based on dissipating a known amount of power in the device for a known period of time so the junction temperature is raised to 150°C. The starting and ending junction temperatures are determined by measuring the forward drop of the body diode. The thermal resistance for that pulse width is defined by the temperature rise of the junction above ambient and the power of the pulse, $\Delta T_{ja}/P$.

Figure 6 shows the single pulse power curve of the Si6436DQ laid over the curve of the Si9936DY to give a comparison of the thermal performance. The die in the two devices have equivalent die areas, making this a comparison of the packaging. This comparison shows that the TSSOP package performs as well as the SOIC out to 150 ms, with long-term performance being 0.5 W less. Although the thermal performance is less, LITTLE FOOT TSSOP will operate in a large percentage of applications that are currently being served by LITTLE FOOT.



Figure 6. Comparison of Thermal Performance

CONCLUSION

TSSOP power MOSFETs provide a significant reduction in PC board footprint and package height, allowing reduction in board size and application where SOICs will not fit. This is accomplished using a standard IC package and a custom leadframe, combining small size with good power handling capability.

For the TSSOP-8 package outline visit:

<http://www.vishay.com/doc?71201>

For the SOIC-8 package outline visit:

<http://www.vishay.com/doc?71192>

Mounting LITTLE FOOT[®] TSSOP-8 Power MOSFETs

Wharton McDaniel

Surface-mounted LITTLE FOOT power MOSFETs use integrated circuit and small-signal packages which have been modified to provide the heat transfer capabilities required by power devices. Leadframe materials and design, molding compounds, and die attach materials have been changed, while the footprint of the packages remains the same.

See Application Note 826, *Recommended Minimum Pad Patterns With Outline Drawing Access for Vishay Siliconix MOSFET*, (<http://www.vishay.com/doc?72286>), for the basis of the pad design for a LITTLE FOOT TSSOP-8 power MOSFET package footprint. In converting the footprint to the pad set for a power device, designers must make two connections: an electrical connection and a thermal connection, to draw heat away from the package.

In the case of the TSSOP-8 package, the thermal connections are very simple. Pins 1, 5, and 8 are the drain of the MOSFET for a single MOSFET package and are connected together. In the dual package, pins 1 and 8 are the two drains. For a small-signal device or integrated circuit, typical connections would be made with traces that are 0.020 inches wide. Since the drain pins also provide the thermal connection to the package, this level of connection is inadequate. The total cross section of the copper may be adequate to carry the current required for the application, but it presents a large thermal impedance. Also, heat spreads in a circular fashion from the heat source. In this case the drain pins are the heat sources when looking at heat spread on the PC board.



FIGURE 1. Single MOSFET TSSOP-8 Pad Pattern with Copper Spreading

The pad patterns with copper spreading for the single-MOSFET TSSOP-8 (Figure 1) and dual-MOSFET TSSOP-8 (Figure 2) show the starting point for utilizing the board area available for the heat-spreading copper. To create this pattern, a plane of copper overlies the drain pins. The copper plane connects the drain pins electrically, but more importantly provides planar copper to draw heat from the drain leads and start the process of spreading the heat so it can be dissipated into the ambient air. These patterns use all the available area underneath the body for this purpose.



FIGURE 2. Dual MOSFET TSSOP-8 Pad Pattern with Copper Spreading

Since surface-mounted packages are small, and reflow soldering is the most common way in which these are affixed to the PC board, "thermal" connections from the planar copper to the pads have not been used. Even if additional planar copper area is used, there should be no problems in the soldering process. The actual solder connections are defined by the solder mask openings. By combining the basic footprint with the copper plane on the drain pins, the solder mask generation occurs automatically.

A final item to keep in mind is the width of the power traces. The absolute minimum power trace width must be determined by the amount of current it has to carry. For thermal reasons, this minimum width should be at least 0.020 inches. The use of wide traces connected to the drain plane provides a low impedance path for heat to move away from the device.

RECOMMENDED MINIMUM PADS FOR TSSOP-8



Recommended Minimum Pads
Dimensions in Inches/(mm)

[Return to Index](#)



Disclaimer

ALL PRODUCT, PRODUCT SPECIFICATIONS AND DATA ARE SUBJECT TO CHANGE WITHOUT NOTICE TO IMPROVE RELIABILITY, FUNCTION OR DESIGN OR OTHERWISE.

Vishay Intertechnology, Inc., its affiliates, agents, and employees, and all persons acting on its or their behalf (collectively, "Vishay"), disclaim any and all liability for any errors, inaccuracies or incompleteness contained in any datasheet or in any other disclosure relating to any product.

Vishay makes no warranty, representation or guarantee regarding the suitability of the products for any particular purpose or the continuing production of any product. To the maximum extent permitted by applicable law, Vishay disclaims (i) any and all liability arising out of the application or use of any product, (ii) any and all liability, including without limitation special, consequential or incidental damages, and (iii) any and all implied warranties, including warranties of fitness for particular purpose, non-infringement and merchantability.

Statements regarding the suitability of products for certain types of applications are based on Vishay's knowledge of typical requirements that are often placed on Vishay products in generic applications. Such statements are not binding statements about the suitability of products for a particular application. It is the customer's responsibility to validate that a particular product with the properties described in the product specification is suitable for use in a particular application. Parameters provided in datasheets and / or specifications may vary in different applications and performance may vary over time. All operating parameters, including typical parameters, must be validated for each customer application by the customer's technical experts. Product specifications do not expand or otherwise modify Vishay's terms and conditions of purchase, including but not limited to the warranty expressed therein.

Except as expressly indicated in writing, Vishay products are not designed for use in medical, life-saving, or life-sustaining applications or for any other application in which the failure of the Vishay product could result in personal injury or death. Customers using or selling Vishay products not expressly indicated for use in such applications do so at their own risk. Please contact authorized Vishay personnel to obtain written terms and conditions regarding products designed for such applications.

No license, express or implied, by estoppel or otherwise, to any intellectual property rights is granted by this document or by any conduct of Vishay. Product names and markings noted herein may be trademarks of their respective owners.