

## Automotive N-Channel 40 V (D-S) 175 °C MOSFET

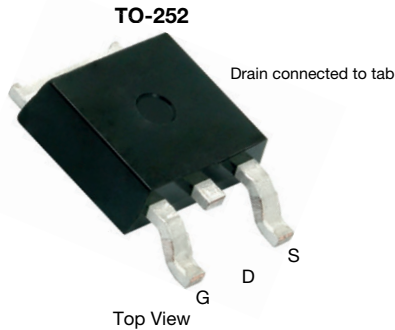

### FEATURES

- TrenchFET® power MOSFET
- Package with low thermal resistance
- 100 % R<sub>g</sub> and UIS tested
- AEC-Q101 qualified
- Material categorization:  
for definitions of compliance please see  
[www.vishay.com/doc?99912](http://www.vishay.com/doc?99912)

 AUTOMOTIVE  
GRADE

**RoHS**  
COMPLIANT  
HALOGEN  
**FREE**

PRODUCT SUMMARY	
V <sub>DS</sub> (V)	40
R <sub>DS(on)</sub> (Ω) at V <sub>GS</sub> = 10 V	0.00233
I <sub>D</sub> (A)	100
Configuration	Single
Package	TO-252

ABSOLUTE MAXIMUM RATINGS (T <sub>C</sub> = 25 °C, unless otherwise noted)				
PARAMETER		SYMBOL	LIMIT	UNIT
Drain-source voltage		V <sub>DS</sub>	40	V
Gate-source voltage		V <sub>GS</sub>	± 20	
Continuous drain current	T <sub>C</sub> = 25 °C <sup>a</sup>	I <sub>D</sub>	100	A
	T <sub>C</sub> = 125 °C		87.5	
Continuous source current (diode conduction)		I <sub>S</sub>	97	
Pulsed drain current <sup>b</sup>		I <sub>DM</sub>	280	
Single pulse avalanche current	L = 0.1 mH	I <sub>AS</sub>	46	
Single pulse avalanche energy		E <sub>AS</sub>	105.8	mJ
Maximum power dissipation <sup>b</sup>	T <sub>C</sub> = 25 °C	P <sub>D</sub>	107	W
	T <sub>C</sub> = 125 °C		35	
Operating junction and storage temperature range		T <sub>J</sub> , T <sub>stg</sub>	-55 to +175	°C

THERMAL RESISTANCE RATINGS				
PARAMETER		SYMBOL	LIMIT	UNIT
Junction-to-ambient	PCB mount <sup>c</sup>	R <sub>thJA</sub>	50	°C/W
Junction-to-case (drain)		R <sub>thJC</sub>	1.4	

### Notes

- Package limited
- Pulse test; pulse width ≤ 300 μs, duty cycle ≤ 2 %
- When mounted on 1" square PCB (FR4 material)



<b>SPECIFICATIONS</b> ( $T_C = 25\text{ }^\circ\text{C}$ , unless otherwise noted)						
PARAMETER	SYMBOL	TEST CONDITIONS	MIN.	TYP.	MAX.	UNIT
<b>Static</b>						
Drain-source breakdown voltage	$V_{DS}$	$V_{GS} = 0\text{ V}, I_D = 250\text{ }\mu\text{A}$	40	-	-	V
Gate-source threshold voltage	$V_{GS(th)}$	$V_{DS} = V_{GS}, I_D = 250\text{ }\mu\text{A}$	2.5	3.0	3.5	
Gate-source leakage	$I_{GSS}$	$V_{DS} = 0\text{ V}, V_{GS} = \pm 20\text{ V}$	-	-	$\pm 100$	nA
Zero gate voltage drain current	$I_{DSS}$	$V_{GS} = 0\text{ V}$ $V_{DS} = 40\text{ V}$	-	-	1	$\mu\text{A}$
		$V_{GS} = 0\text{ V}$ $V_{DS} = 40\text{ V}, T_J = 125\text{ }^\circ\text{C}$	-	-	50	
		$V_{GS} = 0\text{ V}$ $V_{DS} = 40\text{ V}, T_J = 175\text{ }^\circ\text{C}$	-	-	500	$\mu\text{A}$
On-state drain current <sup>a</sup>	$I_{D(on)}$	$V_{GS} = 10\text{ V}$ $V_{DS} \geq 5\text{ V}$	50	-	-	A
Drain-source on-state resistance <sup>a</sup>	$R_{DS(on)}$	$V_{GS} = 10\text{ V}$ $I_D = 20\text{ A}$	-	0.00190	0.00233	
		$V_{GS} = 10\text{ V}$ $I_D = 20\text{ A}, T_J = 125\text{ }^\circ\text{C}$	-	-	0.00390	$\Omega$
		$V_{GS} = 10\text{ V}$ $I_D = 20\text{ A}, T_J = 175\text{ }^\circ\text{C}$	-	-	0.00470	
Forward transconductance <sup>b</sup>	$g_{fs}$	$V_{DS} = 15\text{ V}, I_D = 20\text{ A}$	-	84	-	S
<b>Dynamic <sup>b</sup></b>						
Input capacitance	$C_{iss}$	$V_{GS} = 0\text{ V}$ $V_{DS} = 25\text{ V}, f = 1\text{ MHz}$	-	5405	8000	$\mu\text{F}$
Output capacitance	$C_{oss}$		-	1942	2700	
Reverse transfer capacitance	$C_{rss}$		-	175	250	
Total gate charge <sup>c</sup>	$Q_g$	$V_{GS} = 10\text{ V}$ $V_{DS} = 20\text{ V}, I_D = 50\text{ A}$	-	84	130	nC
Gate-source charge <sup>c</sup>	$Q_{gs}$		-	29.5	-	
Gate-drain charge <sup>c</sup>	$Q_{gd}$		-	19.5	-	
Gate resistance	$R_g$	$f = 1\text{ MHz}$	1	2	3	$\Omega$
Turn-on delay time <sup>c</sup>	$t_{d(on)}$	$V_{DD} = 20\text{ V}, R_L = 0.4\text{ }\Omega$ $I_D \cong 50\text{ A}, V_{GEN} = 10\text{ V}, R_g = 1\text{ }\Omega$	-	17	30	ns
Rise time <sup>c</sup>	$t_r$		-	17	30	
Turn-off delay time <sup>c</sup>	$t_{d(off)}$		-	34	60	
Fall time <sup>c</sup>	$t_f$		-	18	35	
<b>Source-Drain Diode Ratings and Characteristics <sup>b</sup></b>						
Pulsed current <sup>a</sup>	$I_{SM}$		-	-	280	A
Forward voltage	$V_{SD}$	$I_F = 25\text{ A}, V_{GS} = 0\text{ V}$	-	0.8	1.5	V
Body diode reverse recovery time	$t_{rr}$	$I_F = 50\text{ A}, di/dt = 100\text{ A}/\mu\text{s}$	-	41	85	ns
Body diode reverse recovery charge	$Q_{rr}$		-	28	60	nC
Reverse recovery fall time	$t_a$		-	24	-	ns
Reverse recovery rise time	$t_b$		-	17	-	
Body diode peak reverse recovery current	$I_{RM(REC)}$			-	-1.36	-

**Notes**

- a. Pulse test; pulse width  $\leq 300\text{ }\mu\text{s}$ , duty cycle  $\leq 2\%$
- b. Guaranteed by design, not subject to production testing
- c. Independent of operating temperature

Stresses beyond those listed under "Absolute Maximum Ratings" may cause permanent damage to the device. These are stress ratings only, and functional operation of the device at these or any other conditions beyond those indicated in the operational sections of the specifications is not implied. Exposure to absolute maximum rating conditions for extended periods may affect device reliability.



**TYPICAL CHARACTERISTICS** ( $T_A = 25\text{ }^\circ\text{C}$ , unless otherwise noted)

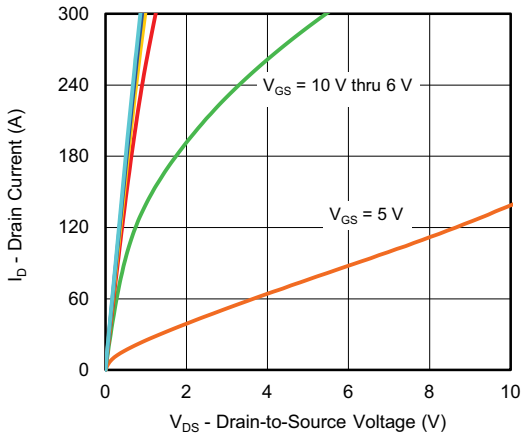

**Output Characteristics**

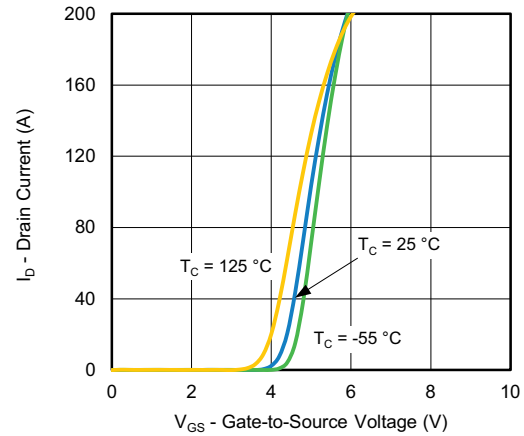

**Transfer Characteristics**

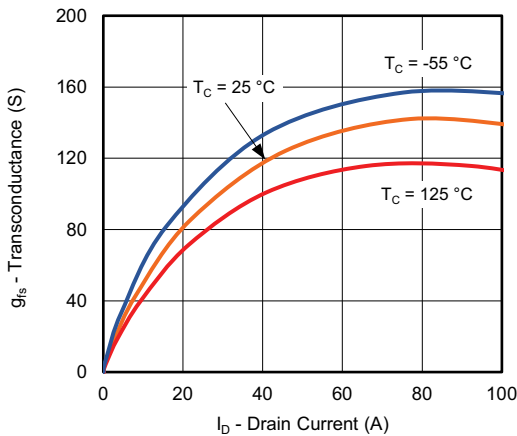

**Transconductance**

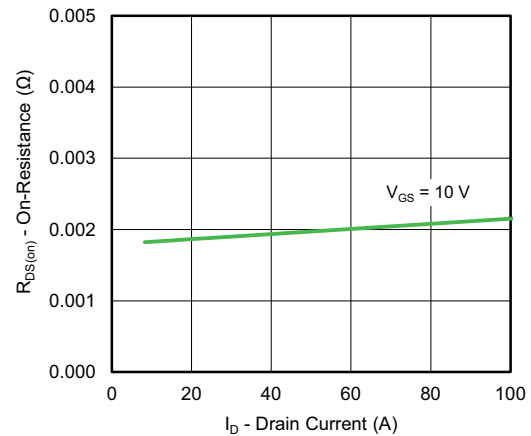

**On-Resistance vs. Drain Current**

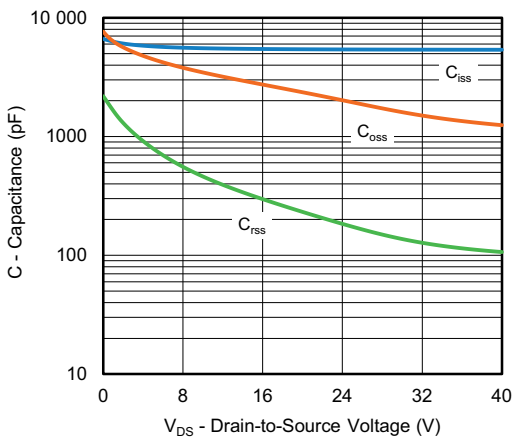

**Capacitance**

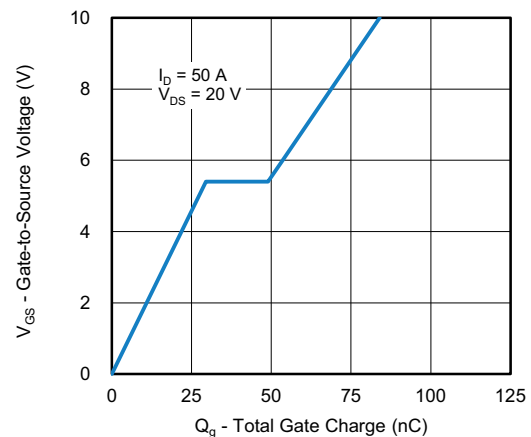

**Gate Charge**



TYPICAL CHARACTERISTICS (T<sub>A</sub> = 25 °C, unless otherwise noted)

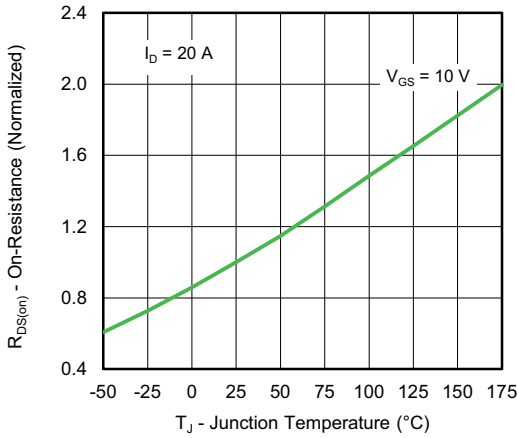

On-Resistance vs. Junction Temperature

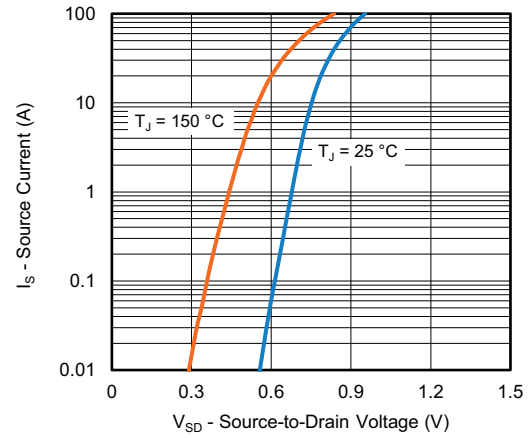

Source Drain Diode Forward Voltage

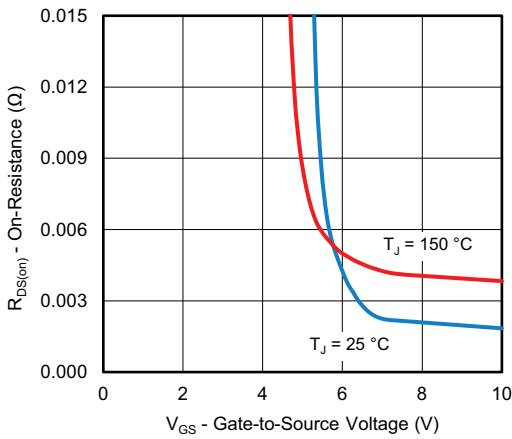

On-Resistance vs. Gate-to-Source Voltage

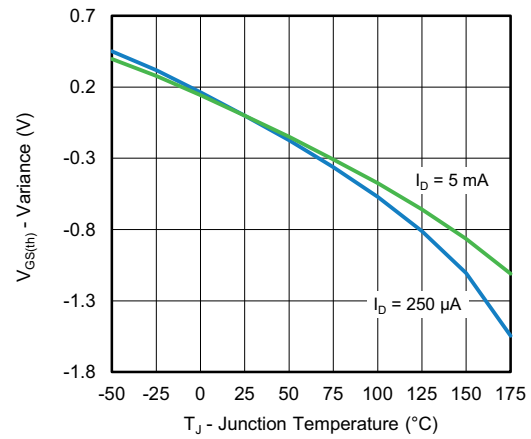

Threshold Voltage

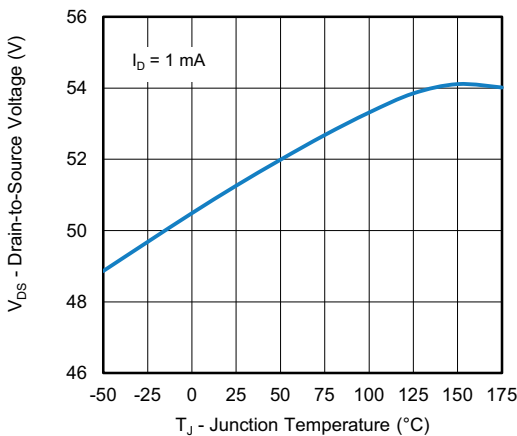

Drain Source Breakdown vs. Junction Temperature

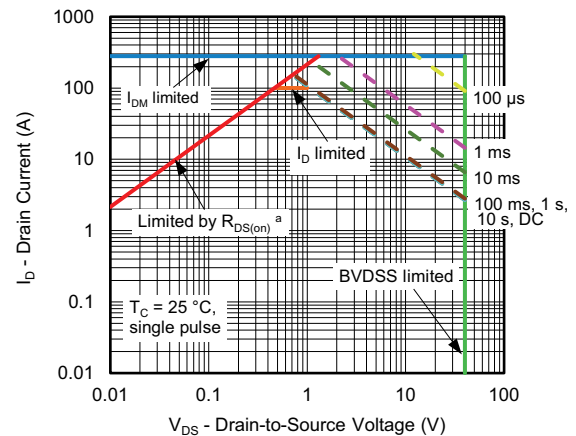

Safe Operating Area

Note

- a. V<sub>GS</sub> > minimum V<sub>GS</sub> at which R<sub>DS(on)</sub> is specified

**THERMAL RATINGS** ( $T_A = 25\text{ }^\circ\text{C}$ , unless otherwise noted)

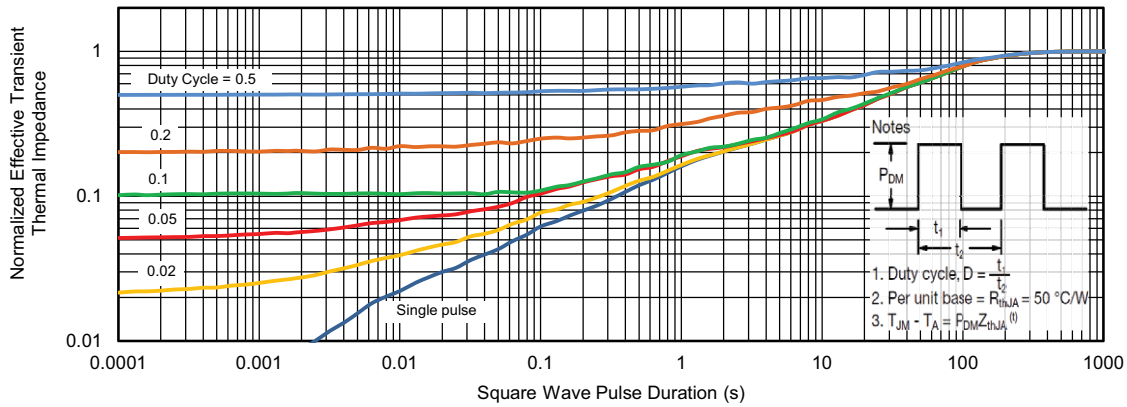

**Normalized Thermal Transient Impedance, Junction-to-Ambient**

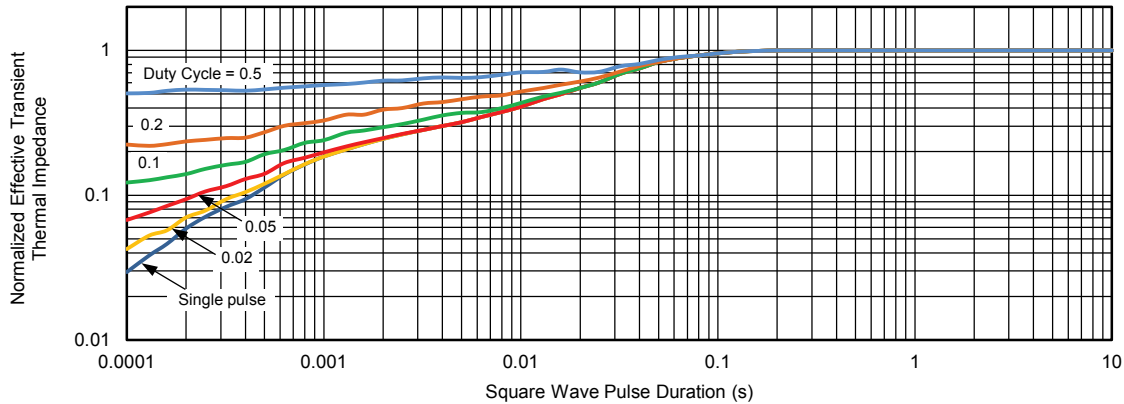

**Normalized Thermal Transient Impedance, Junction-to-Case**

**Note**

- The characteristics shown in the two graphs
  - Normalized Transient Thermal Impedance Junction-to-Ambient ( $25\text{ }^\circ\text{C}$ )
  - Normalized Transient Thermal Impedance Junction-to-Case ( $25\text{ }^\circ\text{C}$ )
 are given for general guidelines only to enable the user to get a “ball park” indication of part capabilities. The data are extracted from single pulse transient thermal impedance characteristics which are developed from empirical measurements. The latter is valid for the part mounted on printed circuit board - FR4, size 1" x 1" x 0.062", double sided with 2 oz. copper, 100 % on both sides. The part capabilities can widely vary depending on actual application parameters and operating conditions

Vishay Siliconix maintains worldwide manufacturing capability. Products may be manufactured at one of several qualified locations. Reliability data for Silicon Technology and Package Reliability represent a composite of all qualified locations. For related documents such as package / tape drawings, part marking, and reliability data, see [www.vishay.com/ppg?76909](http://www.vishay.com/ppg?76909).

## TO-252AA Case Outline

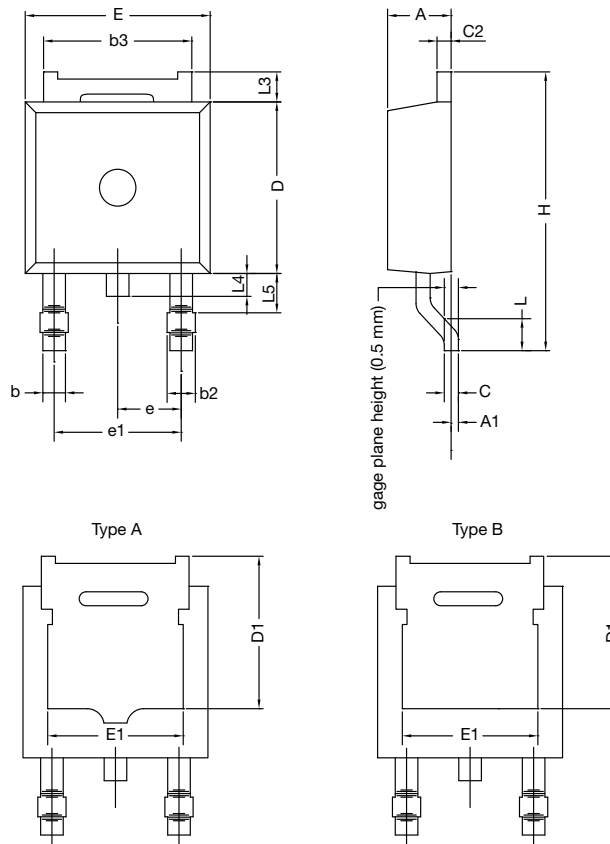

DIM.	MILLIMETERS		INCHES	
	MIN.	MAX.	MIN.	MAX.
A	2.18	2.38	0.086	0.094
A1	-	0.127	-	0.005
b	0.64	0.88	0.025	0.035
b2	0.76	1.14	0.030	0.045
b3	4.95	5.46	0.195	0.215
C	0.46	0.61	0.018	0.024
C2	0.46	0.89	0.018	0.035
D	5.97	6.22	0.235	0.245
D1	4.10	-	0.161	-
E	6.35	6.73	0.250	0.265
E1	4.32	-	0.170	-
H	9.40	10.41	0.370	0.410
e	2.28 BSC		0.090 BSC	
e1	4.56 BSC		0.180 BSC	
L	1.40	1.78	0.055	0.070
L3	0.89	1.27	0.035	0.050
L4	-	1.02	-	0.040
L5	1.01	1.52	0.040	0.060

ECN: T25-0122-Rev. C, 12-May-2025  
DWG: 6019

**Notes**

- Dimension L3 is for reference only
- Dimension D1 and E1 on type A and B is the same

## RECOMMENDED MINIMUM PADS FOR DPAK (TO-252)



Recommended Minimum Pads  
Dimensions in Inches/(mm)

[Return to Index](#)



## **Disclaimer**

ALL PRODUCT, PRODUCT SPECIFICATIONS AND DATA ARE SUBJECT TO CHANGE WITHOUT NOTICE TO IMPROVE RELIABILITY, FUNCTION OR DESIGN OR OTHERWISE.

Vishay Intertechnology, Inc., its affiliates, agents, and employees, and all persons acting on its or their behalf (collectively, "Vishay"), disclaim any and all liability for any errors, inaccuracies or incompleteness contained in any datasheet or in any other disclosure relating to any product.

Vishay makes no warranty, representation or guarantee regarding the suitability of the products for any particular purpose or the continuing production of any product. To the maximum extent permitted by applicable law, Vishay disclaims (i) any and all liability arising out of the application or use of any product, (ii) any and all liability, including without limitation special, consequential or incidental damages, and (iii) any and all implied warranties, including warranties of fitness for particular purpose, non-infringement and merchantability.

Statements regarding the suitability of products for certain types of applications are based on Vishay's knowledge of typical requirements that are often placed on Vishay products in generic applications. Such statements are not binding statements about the suitability of products for a particular application. It is the customer's responsibility to validate that a particular product with the properties described in the product specification is suitable for use in a particular application. Parameters provided in datasheets and / or specifications may vary in different applications and performance may vary over time. All operating parameters, including typical parameters, must be validated for each customer application by the customer's technical experts. Product specifications do not expand or otherwise modify Vishay's terms and conditions of purchase, including but not limited to the warranty expressed therein.

Hyperlinks included in this datasheet may direct users to third-party websites. These links are provided as a convenience and for informational purposes only. Inclusion of these hyperlinks does not constitute an endorsement or an approval by Vishay of any of the products, services or opinions of the corporation, organization or individual associated with the third-party website. Vishay disclaims any and all liability and bears no responsibility for the accuracy, legality or content of the third-party website or for that of subsequent links.

Vishay products are not designed for use in life-saving or life-sustaining applications or any application in which the failure of the Vishay product could result in personal injury or death unless specifically qualified in writing by Vishay. Customers using or selling Vishay products not expressly indicated for use in such applications do so at their own risk. Please contact authorized Vishay personnel to obtain written terms and conditions regarding products designed for such applications.

No license, express or implied, by estoppel or otherwise, to any intellectual property rights is granted by this document or by any conduct of Vishay. Product names and markings noted herein may be trademarks of their respective owners.