

6.5 mΩ, Bidirectional Battery Switch in Compact WCSP

DESCRIPTION

The SiP32103 bidirectional switch feature reverse blocking capability to isolate the battery from the system. The internal switch has an ultra low 6.5 mΩ (typ. at 3.3 V) on-resistance and operates from a +2.3 V to +5.5 V input voltage range, making the devices ideal battery-disconnect switches for high capacity battery applications.

The SiP32103 has slew rate control, making it ideal in large load capacitor as well as high current load switching applications. This device is also highly efficient, consuming only 110 nA (typ.) current in shutdown and 8.2 μA while operating.

The SiP32103 has an active low enable. It can interface directly with a low voltage control signal.

The SiP32103 is available in an ultra compact 12-bump, 1.3 mm x 1.7 mm, 0.4 mm pitch WCSP package with top side lamination. The device operates over the temperature of -40 °C to +85 °C.

FEATURES

- Bi-directional on and off
- 7 A continuous current capability
- Ultra-low R_{on} , 6.5 mΩ (typ.) at 3.3 V
- Wide input voltage, 2.3 V to 5.5 V
- Slew rate controlled turn on
- Low quiescent current: 8.2 μA (typ.)
- EN pin with integrated pull up or pull down resistor
- Compact 12-bump, 1.3 mm x 1.7 mm x 0.55 mm WCSP package
- Material categorization: for definitions of compliance please see www.vishay.com/doc?99912



RoHS
COMPLIANT
HALOGEN
FREE

APPLICATIONS

- Smartphones and tablets
- Digital still / video cameras
- Portable meters and test instruments
- Communication devices with embedded batteries
- Portable medical and healthcare systems
- Data storage
- Battery bank

TYPICAL APPLICATION CIRCUIT

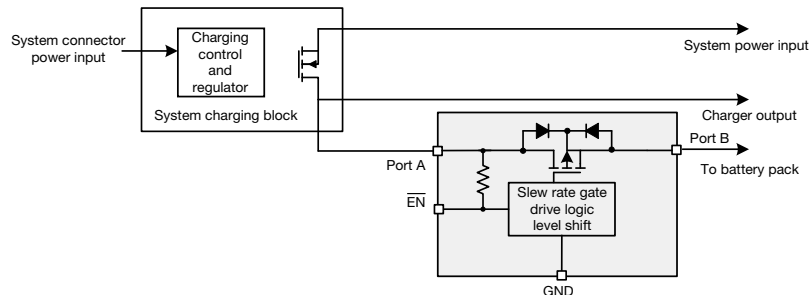

Fig. 1 - Typical Application Circuit

ORDERING INFORMATION					
PART NUMBER	MARKING	ENABLE	ENABLE PULL RESISTOR	PACKAGE	TEMPERATURE
SiP32103DB-T1-GE1	32103A	Low	Enable pull High	12-bump, 1.3 mm x 1.7 mm, 0.4 mm pitch WCSP package	-40 °C to +85 °C
SiP32103EVB	-	-	-	Evaluation board	-

Note

- GE1 denotes halogen-free and RoHS-compliant

MARKING

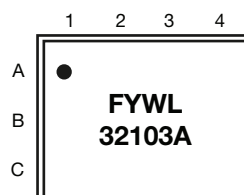



ABSOLUTE MAXIMUM RATINGS			
PARAMETER	CONDITIONS	LIMIT	UNIT
V_{PA}, V_{PB}	Reference to GND	-0.3 to +6	V
	Pulse at 1 ms reference to GND ^a	-1.6	
V_{EN}	Reference to GND	-0.3 to +6	
Maximum continuous switch current		7	A
Maximum pulse current	100 μ s pulse	15	
ESD (HBM)		8000	V
Operating temperature		-40 to +85	°C
Operating junction temperature		125	
Storage temperature		-65 to +150	
Thermal resistance (θ_{JA}) ^b		73	°C/W
Power dissipation (P_D) ^{b, c}	$T_A = 70$ °C	1096	mW

Notes

- a. Negative current injection up to 300 mA
b. All bumps soldered to 1" x 1", 2 oz. copper, 4 layers PC board
c. Derate 13.7 mW/°C above $T_A = 70$ °C

Stresses beyond those listed under "Absolute Maximum Ratings" may cause permanent damage to the device. These are stress ratings only, and functional operation of the device at these or any other conditions beyond those indicated in the operational sections of the specifications is not implied. Exposure to absolute maximum rating/conditions for extended periods may affect device reliability.

SPECIFICATIONS						
PARAMETER	SYMBOL	TEST CONDITIONS UNLESS SPECIFIED $V_{IN} = V_{PA}/V_{PB} = 2.3$ V to 5.5 V, $T_A = -40$ °C to 85 °C (Typical values are at $V_{PA}, V_{PB} = 4.2$ V, $C_{PA}, C_{PB} = 0.1$ μ F, $T_A = 25$ °C)	LIMITS			UNIT
			MIN. ^a	TYP. ^b	MAX. ^a	
Power Supply						
Operating voltage ^c	$V_{PA/PB}$		2.3	-	5.5	V
Quiescent current	I_Q	$V_{EN} = 0$ V, no load	-	8.2	15	μ A
Shutdown current	I_{SHDN}	$V_{EN} = V_{IN}$, no load	-	110	400	nA
Internal FET						
On-resistance	$R_{DS(on)}$	$V_{PA}/V_{PB} = 2.3$ V, $I_L = 500$ mA, $T_A = 25$ °C	-	8	13	m Ω
		$V_{PA}/V_{PB} = 3.3$ V, $I_L = 500$ mA, $T_A = 25$ °C	-	6.5	10	
Control						
\overline{EN} input logic-low voltage ^c	V_{IL}		-	-	0.4	V
\overline{EN} input logic-high voltage ^c	V_{IH}		1.4	-	-	
\overline{EN} input logic hysteresis	$V_{I(HYS)}$		-	> 200	-	mV
\overline{EN} pull resistor	R_{EN}	$V_{PA}/V_{PB} = 5.5$ V, V_{EN} (or V_{EN}) = 2.3 V	-	500	700	k Ω
Timing						
Output turn-on delay time	$t_{d(on)}$	$V_{IN} = 4.2$ V, $R_L = 100$ Ω , $C_L = 0.1$ μ F, $T_A = 25$ °C	-	0.8	-	ms
Output turn-on rise time	t_r		-	1	-	
Output turn-off delay time	$t_{d(off)}$		-	0.12	-	
Output turn-off fall time	t_f		-	0.1	-	

Notes

- a. The algebraic convention whereby the most negative value is a minimum and the most positive a maximum
b. Typical values are for DESIGN AID ONLY, not guaranteed nor subject to production testing
c. For V_{IN} outside this range consult typical \overline{EN} , EN threshold curve

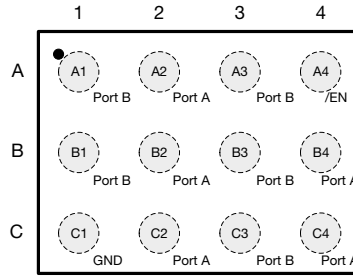
BUMP CONFIGURATION

Top view
(solder bumps on bottom)

Fig. 2 - WCSP12, 1.3 mm x 1.7 mm

BUMP DESCRIPTION		
BUMP NUMBER	NAME	FUNCTION
A1, B1, A3, B3, C3	PB	Power port B
C1	GND	Ground
A2, B2, C2, B4, C4	PA	Power port A
A4	$\overline{\text{EN}}$	Switch enable input, active low

FUNCTIONAL BLOCK DIAGRAM

TYPICAL CHARACTERISTICS (internally regulated 25 °C, unless otherwise noted)

Fig. 3 - Quiescent vs. Input Voltage

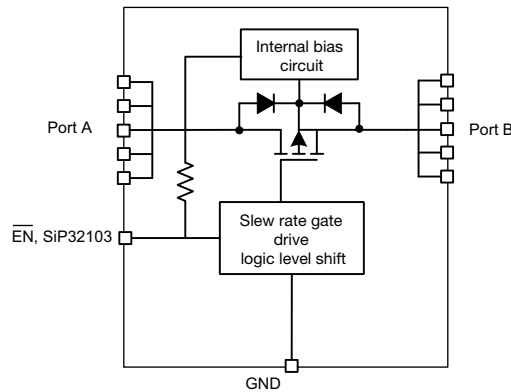
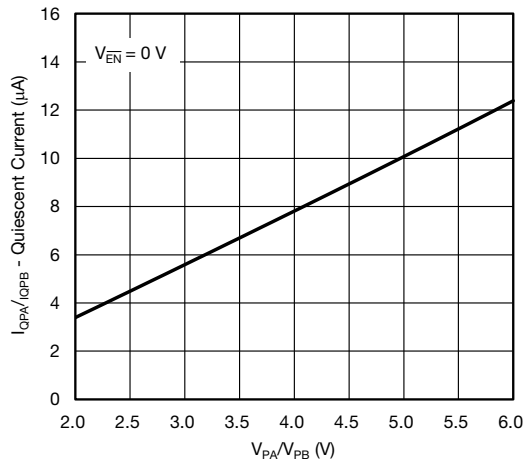
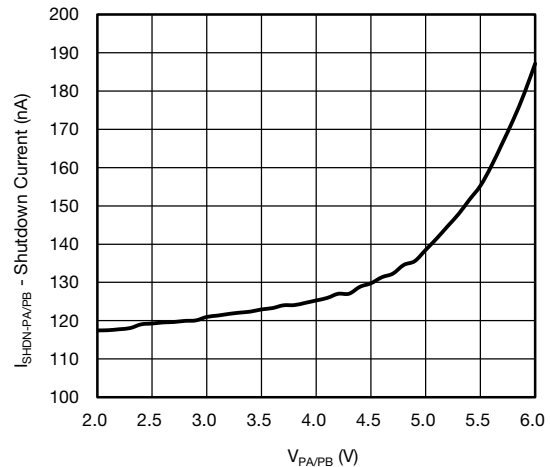

Fig. 4 - Shutdown Current vs. Input Voltage

TYPICAL CHARACTERISTICS (internally regulated 25 °C, unless otherwise noted)

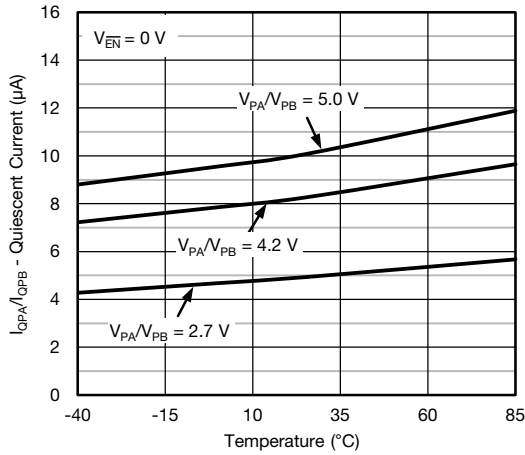

Fig. 5 - Quiescent vs. Temperature

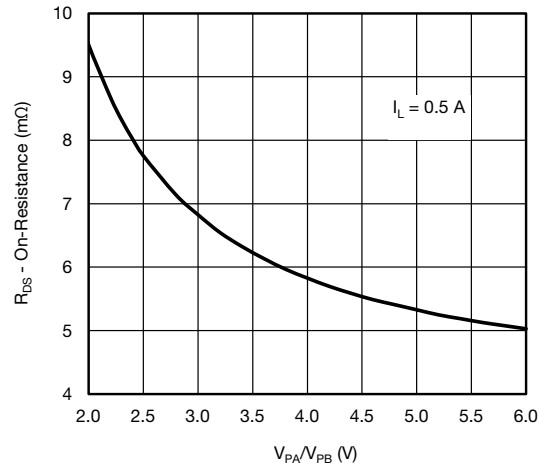

Fig. 8 - On Resistance vs. Input Voltage

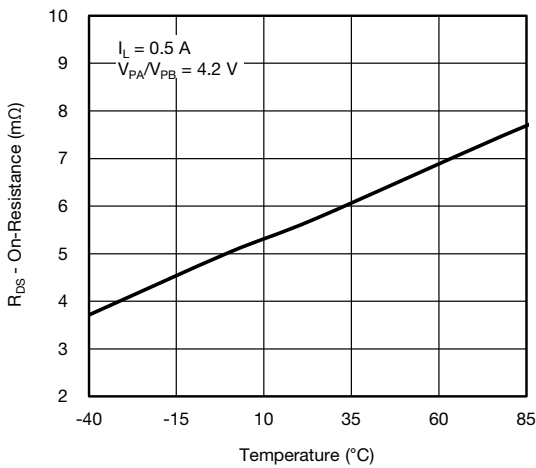

Fig. 6 - On Resistance vs. Temperature

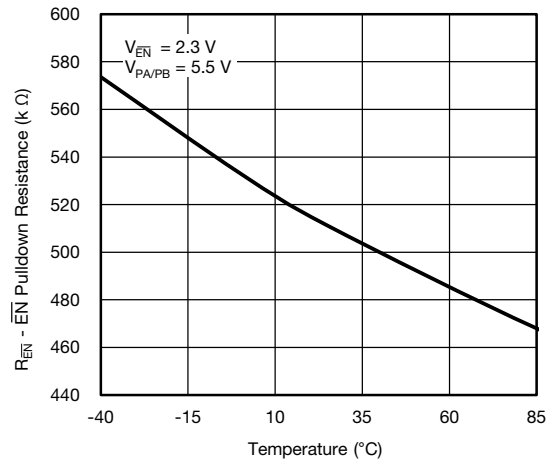

Fig. 9 - EN Pull down Resistance vs. Temperature

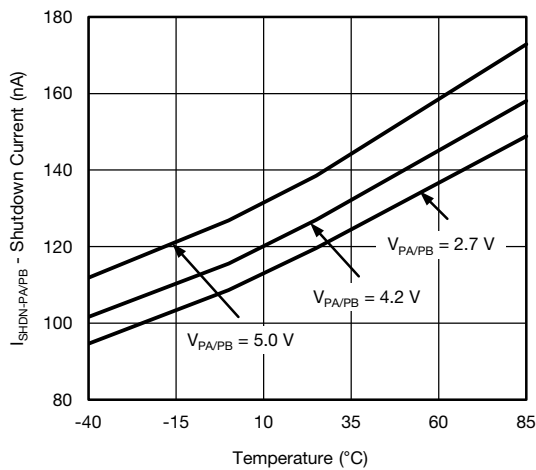

Fig. 7 - Shutdown Current vs. Temperature

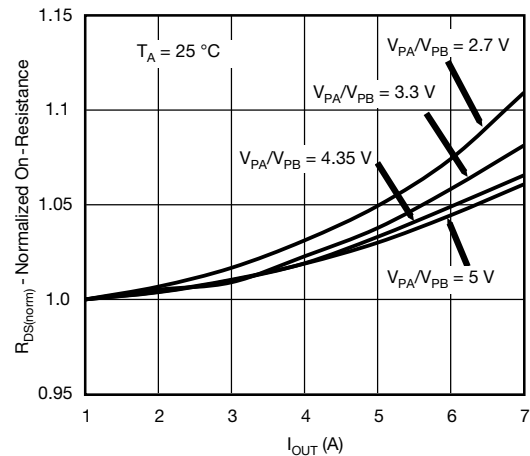

Fig. 10 - Normalized On Resistance vs. Load Current

TYPICAL CHARACTERISTICS (internally regulated 25 °C, unless otherwise noted)

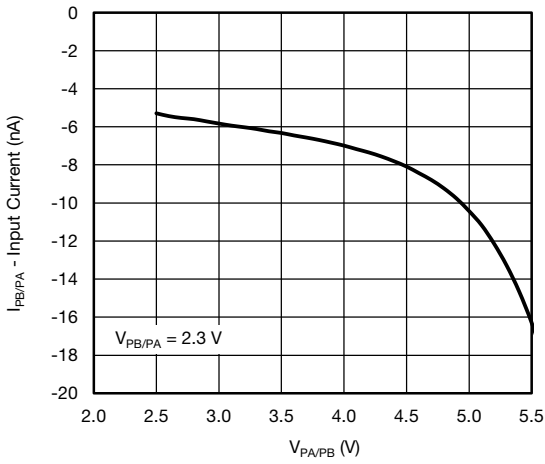

Fig. 11 - Reverse Blocking Current (I_{RB}) vs. Output Voltage

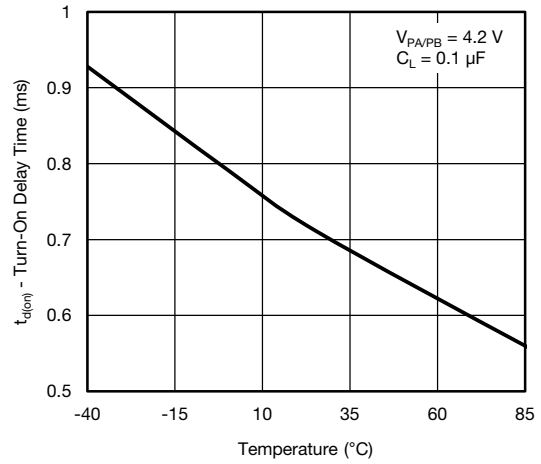

Fig. 14 - Turn-on Delay Time vs. Temperature

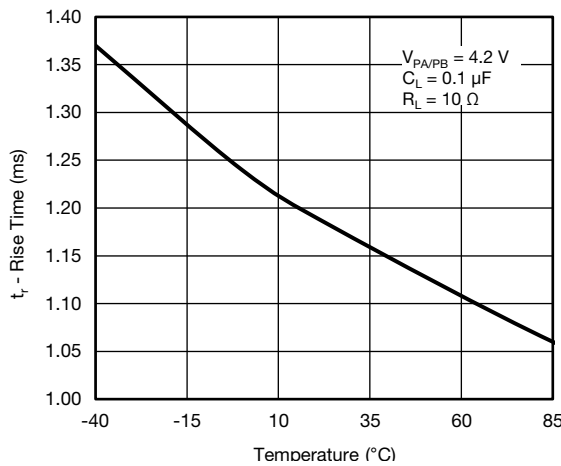

Fig. 12 - Rise Time vs. Temperature

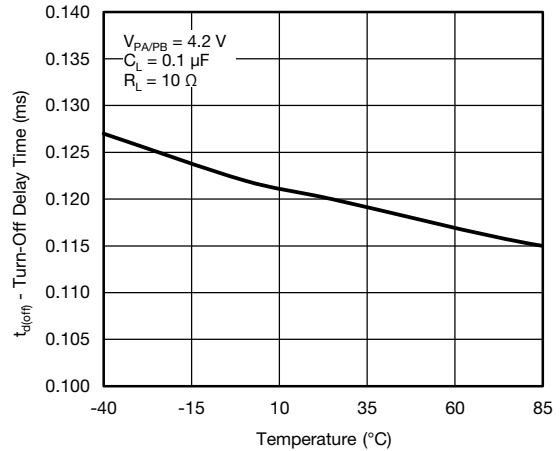

Fig. 15 - Turn-off Delay Time vs. Temperature

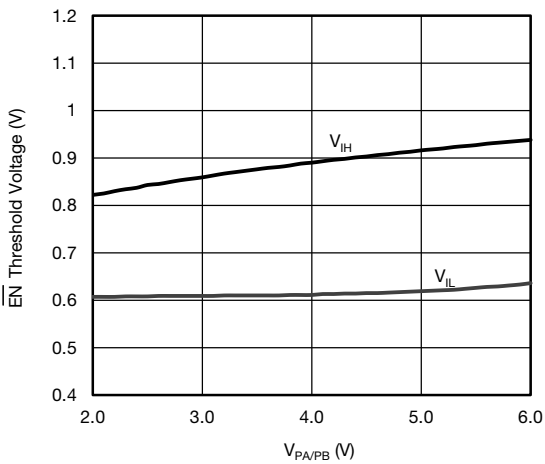

Fig. 13 - \overline{EN} Threshold Voltage vs. Input Voltage

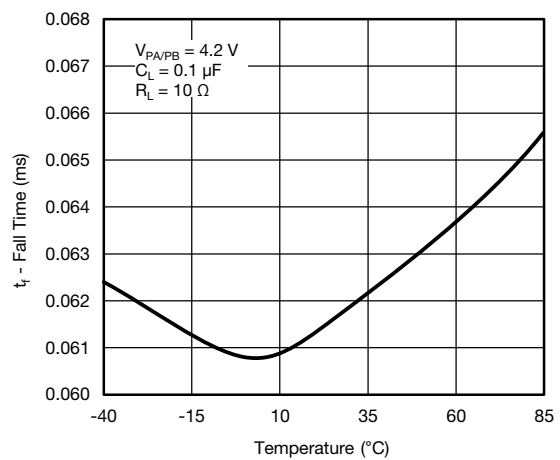

Fig. 16 - Fall Time vs. Temperature

DETAILED DESCRIPTION

The SiP32103 bidirectional switch features reverse blocking capability to isolate the battery from the system. The internal switch has an ultra low 6.5 mΩ (typ. at 3.3 V) on-resistance and operates from a +2.3 V to +5.5 V input voltage range, making the device ideal battery-disconnect switch for high capacity battery applications. The parts can handle 7 A continuous current at both directions.

The SiP32103 has slew rate control, making it ideal in large load capacitor as well as high current load switching applications.

The SiP32103 is available in an ultra compact 12-bump, 1.3 mm x 1.7 mm, 0.4 mm pitch WCSP package with top side lamination. The device operates over the temperature of -40 °C to +85 °C.

REVERSE CURRENT BLOCKING

The SiP32103 is a bidirectional switch that prevent current flowing from either port to the other when the device is disabled.

EN INPUT

SiP32103 has an active-low enable pin which can interface with low voltage GPIO directly. The switch is on when EN is low and off when EN is high. The SiP32103 EN pin integrates a pull up resistor that will automatically connected to either port A or port whichever is of higher voltage.

SWITCH ON AND OFF PERFORMANCE

The SiP32103 has a slew rate control. This minimizes the inrush current and provides a soft turn on.

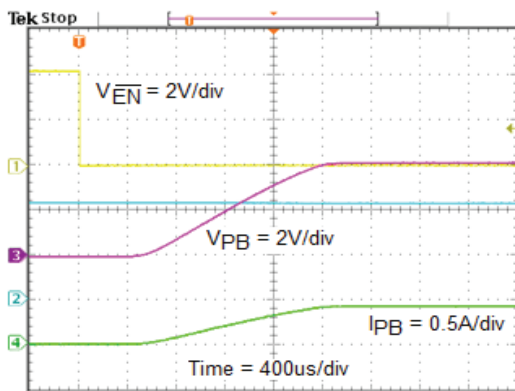

Fig. 17 - Port B Turn-On Time
(V_{PA} = 4.2 V, R_L = 10 Ω, C_L = 0.1 μF)

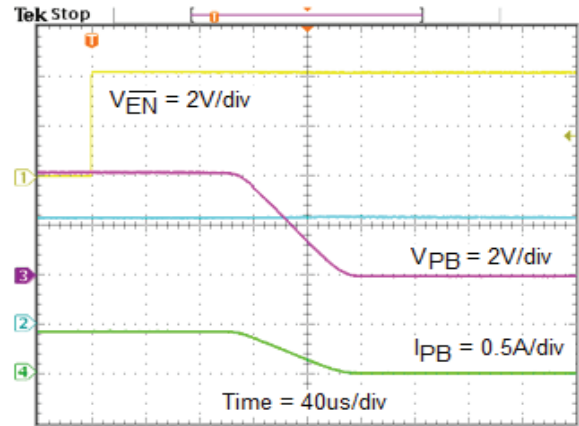

Fig. 18 - Port B Turn-Off Time
(V_{PA} = 4.2 V, R_L = 10 Ω, C_L = 0.1 μF)

DEVICE PIN OUT

Device pin out is designed for ease of layout.

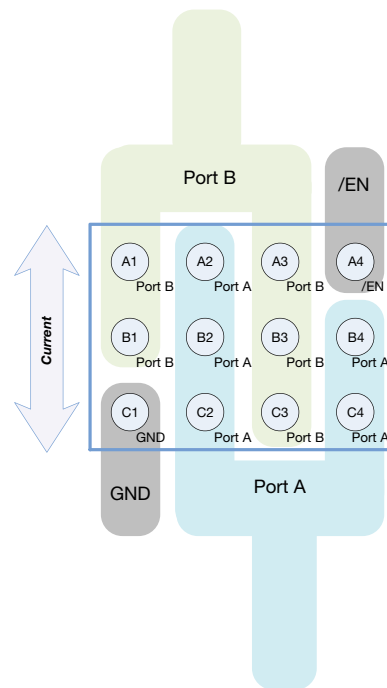
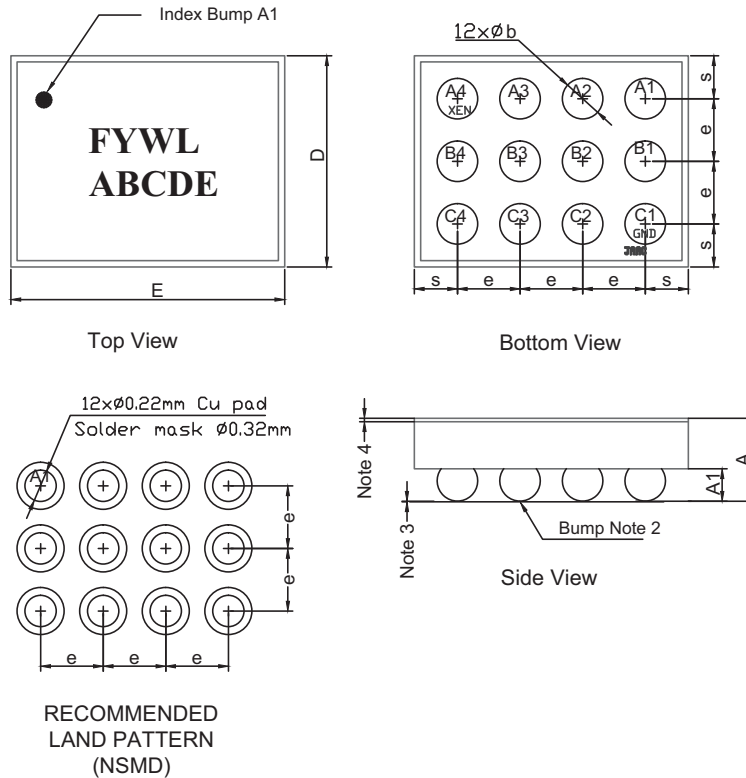

Fig. 19 - Proposed Layout

Vishay Siliconix maintains worldwide manufacturing capability. Products may be manufactured at one of several qualified locations. Reliability data for Silicon Technology and Package Reliability represent a composite of all qualified locations. For related documents such as package / tape drawings, part marking, and reliability data, see www.vishay.com/ppg?78814.

WCSP12: 12 Bumps

(3 x 4, 0.4 mm pitch, 208 μm bump height, 1.71 mm x 1.31 mm die size)



DIMENSION	MILLIMETERS ⁽⁵⁾			INCHES		
	MIN.	NOM.	MAX.	MIN.	NOM.	MAX.
A	0.515	0.530	0.545	0.0203	0.0209	0.0215
A1	0.183	0.208	0.233	0.0072	0.0082	0.0092
b	0.234	0.260	0.312	0.0092	0.0102	0.0123
e	0.400			0.0157		
s	0.235	0.255	0.275	0.0093	0.0100	0.0108
D	1.270	1.310	1.350	0.0500	0.0516	0.0531
E	1.670	1.710	1.750	0.0657	0.0673	0.0689

Notes (unless otherwise specified)

- (1) Laser mark on the silicon die back coated with an epoxy film.
- (2) Bumps are SAC396.
- (3) 0.050 max. co-planarity.
- (4) Laminate tape thickness is 0.022 mm.
- (5) Use millimeters as the primary measurement.

ECN: S13-2510-Rev. B, 16-Dec-13
 DWG: 6017



Disclaimer

ALL PRODUCT, PRODUCT SPECIFICATIONS AND DATA ARE SUBJECT TO CHANGE WITHOUT NOTICE TO IMPROVE RELIABILITY, FUNCTION OR DESIGN OR OTHERWISE.

Vishay Intertechnology, Inc., its affiliates, agents, and employees, and all persons acting on its or their behalf (collectively, "Vishay"), disclaim any and all liability for any errors, inaccuracies or incompleteness contained in any datasheet or in any other disclosure relating to any product.

Vishay makes no warranty, representation or guarantee regarding the suitability of the products for any particular purpose or the continuing production of any product. To the maximum extent permitted by applicable law, Vishay disclaims (i) any and all liability arising out of the application or use of any product, (ii) any and all liability, including without limitation special, consequential or incidental damages, and (iii) any and all implied warranties, including warranties of fitness for particular purpose, non-infringement and merchantability.

Statements regarding the suitability of products for certain types of applications are based on Vishay's knowledge of typical requirements that are often placed on Vishay products in generic applications. Such statements are not binding statements about the suitability of products for a particular application. It is the customer's responsibility to validate that a particular product with the properties described in the product specification is suitable for use in a particular application. Parameters provided in datasheets and / or specifications may vary in different applications and performance may vary over time. All operating parameters, including typical parameters, must be validated for each customer application by the customer's technical experts. Product specifications do not expand or otherwise modify Vishay's terms and conditions of purchase, including but not limited to the warranty expressed therein.

Except as expressly indicated in writing, Vishay products are not designed for use in medical, life-saving, or life-sustaining applications or for any other application in which the failure of the Vishay product could result in personal injury or death. Customers using or selling Vishay products not expressly indicated for use in such applications do so at their own risk. Please contact authorized Vishay personnel to obtain written terms and conditions regarding products designed for such applications.

No license, express or implied, by estoppel or otherwise, to any intellectual property rights is granted by this document or by any conduct of Vishay. Product names and markings noted herein may be trademarks of their respective owners.