

Silicon NPN Phototransistor, RoHS Compliant

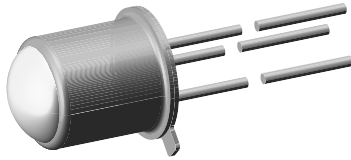

94 8401

DESCRIPTION

BPW77 is a silicon NPN phototransistor with high radiant sensitivity in hermetically sealed TO-18 package with base terminal and glass lens. It is sensitive to visible and near infrared radiation.

FEATURES

- Package type: leaded
- Package form: TO-18
- Dimensions (in mm): \varnothing 4.7
- High photo sensitivity
- High radiant sensitivity
- Suitable for visible and near infrared radiation
- Fast response times
- Angle of half sensitivity: $\varphi = \pm 10^\circ$
- Base terminal connected
- Hermetically sealed package
- Lead (Pb)-free component in accordance with RoHS 2002/95/EC and WEEE 2002/96/EC



RoHS
COMPLIANT

APPLICATIONS

- Detector in electronic control and drive circuits

PRODUCT SUMMARY

COMPONENT	I_{ca} (mA)	φ (deg)	$\lambda_{0.1}$ (nm)
BPW77NA	7.5 to 15	± 10	450 to 1080
BPW77NB	> 10	± 10	450 to 1080

Note

Test condition see table "Basic Characteristics"

ORDERING INFORMATION

ORDERING CODE	PACKAGING	REMARKS	PACKAGE FORM
BPW77NA	Bulk	MOQ: 1000 pcs, 1000 pcs/bulk	TO-18
BPW77NB	Bulk	MOQ: 1000 pcs, 1000 pcs/bulk	TO-18

Note

MOQ: minimum order quantity

ABSOLUTE MAXIMUM RATINGS

PARAMETER	TEST CONDITION	SYMBOL	VALUE	UNIT
Collector base voltage		V_{CBO}	80	V
Collector emitter voltage		V_{CEO}	70	V
Emitter base voltage		V_{EBO}	5	V
Collector current		I_C	50	mA
Collector peak current	$t_p/T = 0.5, t_p \leq 10$ ms	I_{CM}	100	mA
Total power dissipation	$T_{amb} \leq 25$ °C	P_V	250	mW
Junction temperature		T_j	125	°C
Operating temperature range		T_{amb}	- 40 to + 125	°C
Storage temperature range		T_{stg}	- 40 to + 125	°C
Soldering temperature	$t \leq 5$ s	T_{sd}	260	°C
Thermal resistance junction/ambient	Connected with Cu wire, 0.14 mm ²	R_{thJA}	400	K/W
Thermal resistance junction/gase		R_{thJC}	150	K/W

Note

$T_{amb} = 25$ °C, unless otherwise specified

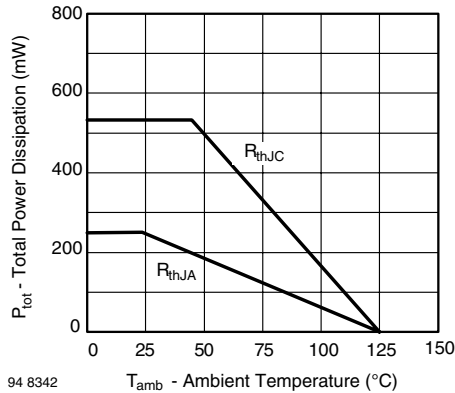

Fig. 1 - Power Dissipation Limit vs. Ambient Temperature

BASIC CHARACTERISTICS						
PARAMETER	TEST CONDITION	SYMBOL	MIN.	TYP.	MAX.	UNIT
Collector emitter breakdown voltage	$I_C = 1 \text{ mA}$	$V_{(BR)CEO}$	70			V
Collector emitter dark current	$V_{CE} = 20 \text{ V}, E = 0$	I_{CEO}		1	100	nA
Collector emitter capacitance	$V_{CE} = 5 \text{ V}, f = 1 \text{ MHz}, E = 0$	C_{CEO}		6		pF
Angle of half sensitivity		ϕ		± 10		deg
Wavelength of peak sensitivity		λ_p		850		nm
Range of spectral bandwidth		$\lambda_{0.1}$		450 to 1080		nm
Collector emitter saturation voltage	$E_e = 1 \text{ mW/cm}^2, \lambda = 950 \text{ nm}, I_C = 1 \text{ mA}$	V_{CEsat}		0.15	0.3	V
Turn-on time	$V_S = 5 \text{ V}, I_C = 5 \text{ mA}, R_L = 100 \Omega$	t_{on}		6		μs
Turn-off time	$V_S = 5 \text{ V}, I_C = 5 \text{ mA}, R_L = 100 \Omega$	t_{off}		5		μs
Cut-off frequency	$V_S = 5 \text{ V}, I_C = 5 \text{ mA}, R_L = 100 \Omega$	f_c		110		kHz

Note

$T_{amb} = 25 \text{ }^\circ\text{C}$, unless otherwise specified

TYPE DEDICATED CHARACTERISTICS							
PARAMETER	TEST CONDITION	PART	SYMBOL	MIN.	TYP.	MAX.	UNIT
Collector light current	$E_e = 1 \text{ mW/cm}^2, \lambda = 950 \text{ nm}, V_{CE} = 5 \text{ V}$	BPW77NA	I_{ca}	7.5		15	mA
		BPW77NB	I_{ca}	10			mA

BASIC CHARACTERISTICS

$T_{amb} = 25 \text{ }^\circ\text{C}$, unless otherwise specified

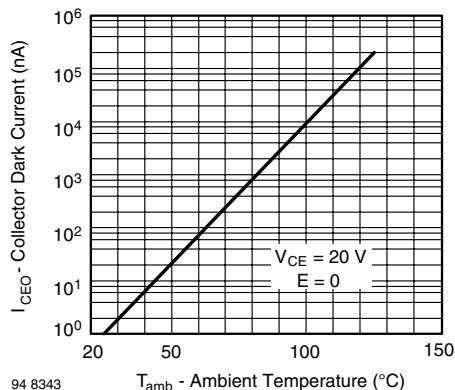

Fig. 2 - Collector Dark Current vs. Ambient Temperature

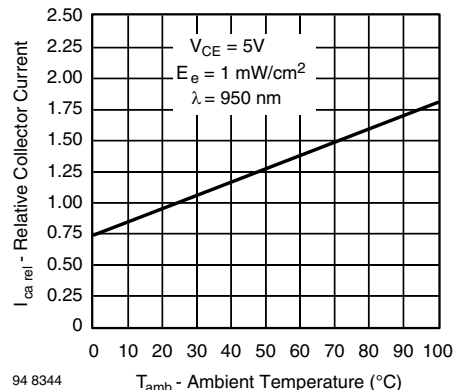
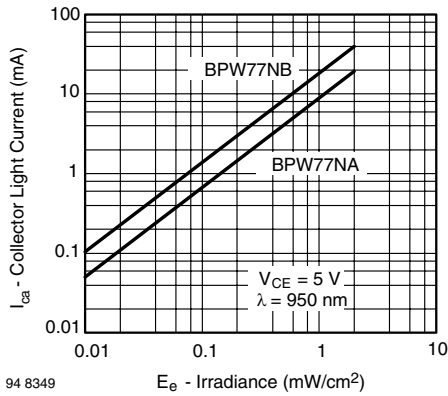
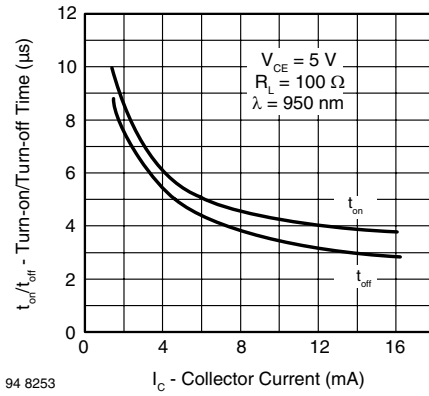

Fig. 3 - Relative Collector Current vs. Ambient Temperature



94 8349

Fig. 4 - Collector Light Current vs. Irradiance



94 8253

Fig. 7 - Turn-on/Turn-off Time vs. Collector Current

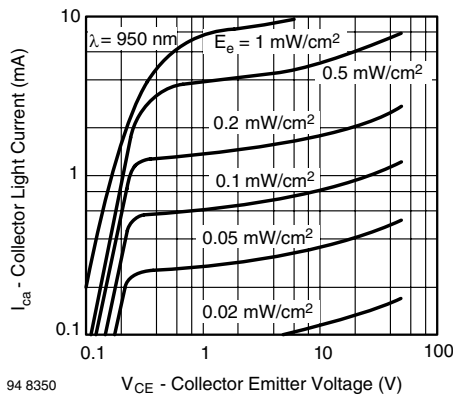

94 8350

Fig. 5 - Collector Light Current vs. Collector Emitter Voltage

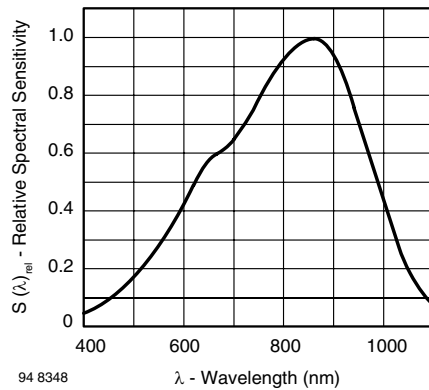

94 8348

Fig. 8 - Relative Spectral Sensitivity vs. Wavelength

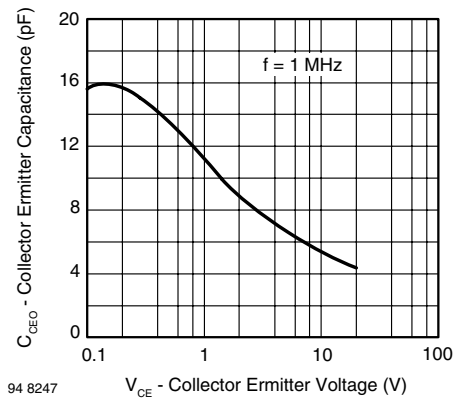

94 8247

Fig. 6 - Collector Emitter Capacitance vs. Collector Emitter Voltage

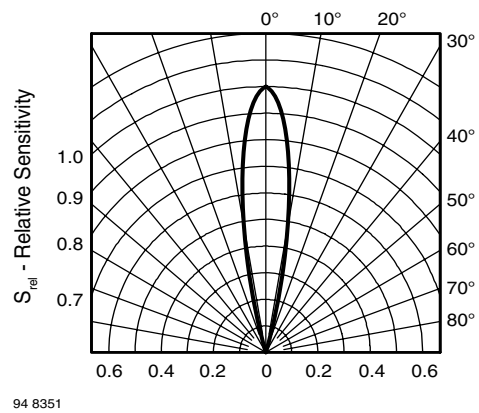

94 8351

Fig. 9 - Relative Radiant Sensitivity vs. Angular Displacement



BPW77NA, BPW77NB

Silicon NPN Phototransistor, RoHS Compliant Vishay Semiconductors

PACKAGE DIMENSIONS in millimeters

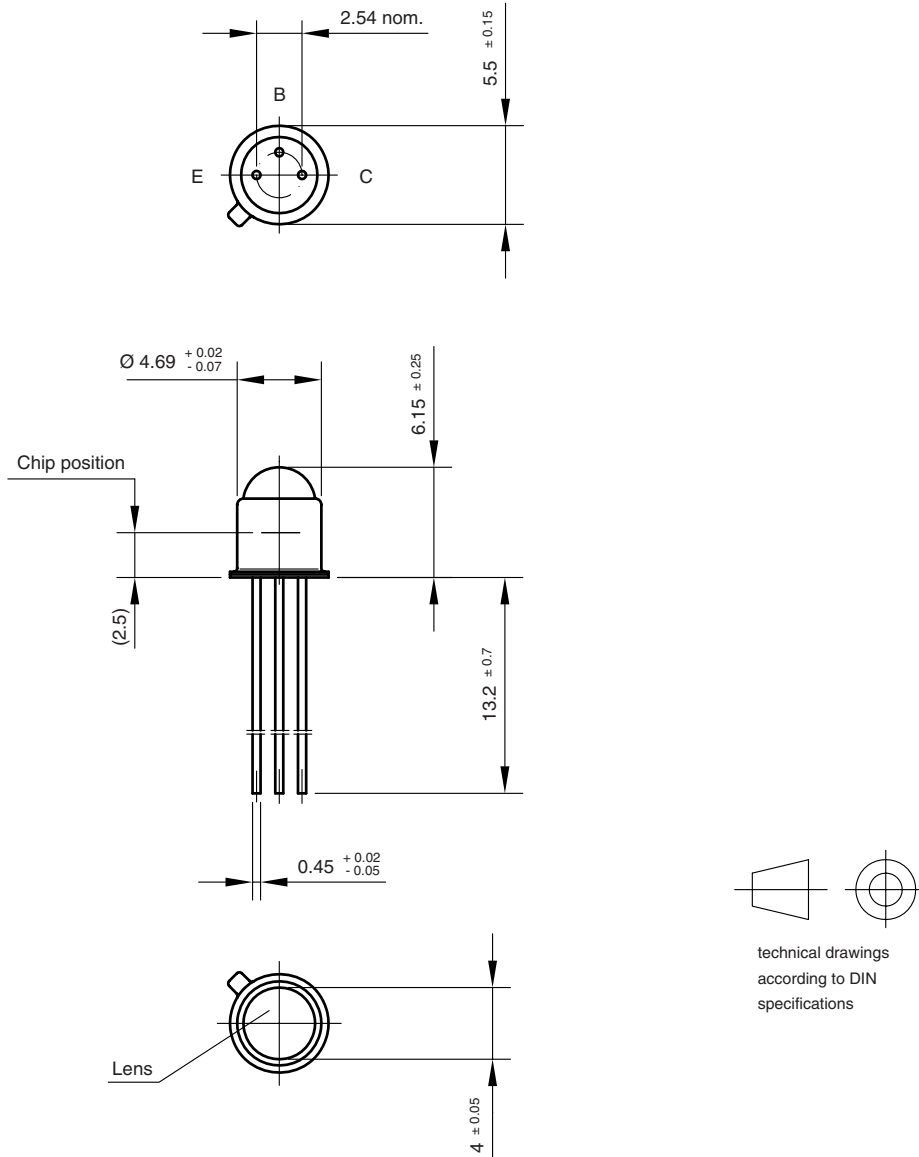

Drawing-No.: 6.503-5023.01-4
Issue: 1; 01.07.96
96 12180



Disclaimer

ALL PRODUCT, PRODUCT SPECIFICATIONS AND DATA ARE SUBJECT TO CHANGE WITHOUT NOTICE TO IMPROVE RELIABILITY, FUNCTION OR DESIGN OR OTHERWISE.

Vishay Intertechnology, Inc., its affiliates, agents, and employees, and all persons acting on its or their behalf (collectively, "Vishay"), disclaim any and all liability for any errors, inaccuracies or incompleteness contained in any datasheet or in any other disclosure relating to any product.

Vishay makes no warranty, representation or guarantee regarding the suitability of the products for any particular purpose or the continuing production of any product. To the maximum extent permitted by applicable law, Vishay disclaims (i) any and all liability arising out of the application or use of any product, (ii) any and all liability, including without limitation special, consequential or incidental damages, and (iii) any and all implied warranties, including warranties of fitness for particular purpose, non-infringement and merchantability.

Statements regarding the suitability of products for certain types of applications are based on Vishay's knowledge of typical requirements that are often placed on Vishay products in generic applications. Such statements are not binding statements about the suitability of products for a particular application. It is the customer's responsibility to validate that a particular product with the properties described in the product specification is suitable for use in a particular application. Parameters provided in datasheets and/or specifications may vary in different applications and performance may vary over time. All operating parameters, including typical parameters, must be validated for each customer application by the customer's technical experts. Product specifications do not expand or otherwise modify Vishay's terms and conditions of purchase, including but not limited to the warranty expressed therein.

Except as expressly indicated in writing, Vishay products are not designed for use in medical, life-saving, or life-sustaining applications or for any other application in which the failure of the Vishay product could result in personal injury or death. Customers using or selling Vishay products not expressly indicated for use in such applications do so at their own risk and agree to fully indemnify and hold Vishay and its distributors harmless from and against any and all claims, liabilities, expenses and damages arising or resulting in connection with such use or sale, including attorneys fees, even if such claim alleges that Vishay or its distributor was negligent regarding the design or manufacture of the part. Please contact authorized Vishay personnel to obtain written terms and conditions regarding products designed for such applications.

No license, express or implied, by estoppel or otherwise, to any intellectual property rights is granted by this document or by any conduct of Vishay. Product names and markings noted herein may be trademarks of their respective owners.