

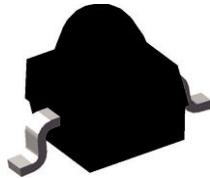

## Silicon PIN Photodiode



21568-1

VEMD2020X01

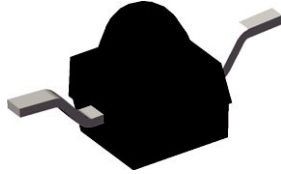

VEMD2000X01

### DESCRIPTION

VEMD2000X01 and VEMD2020X01 are high speed and high sensitive PIN photodiodes in a miniature surface mount package (SMD) with dome lens and daylight blocking filter. Filter is matched with IR emitters operating at wavelength of 830 nm to 950 nm. The photo sensitive area of the chip is 0.23 mm<sup>2</sup>.

### FEATURES

- Package type: surface mount
- Package form: GW, RGW
- Dimensions (L x W x H in mm): 2.3 x 2.3 x 2.8
- AEC-Q101 qualified
- High radiant sensitivity
- Daylight blocking filter matched with 830 nm to 950 nm IR emitters
- Fast response times
- Angle of half sensitivity:  $\phi = \pm 15^\circ$
- Package matched with IR emitter series VSMB2000X01
- Floor life: 4 weeks, MSL 2a, acc. J-STD-020
- Lead (Pb)-free reflow soldering
- Compliant to RoHS Directive 2002/95/EC and in accordance to WEEE 2002/96/EC



### Note

\*\* Please see document "Vishay Material Category Policy": [www.vishay.com/doc?99902](http://www.vishay.com/doc?99902)

### APPLICATIONS

- High speed photo detector
- Infrared remote control
- Infrared data transmission
- Photo interrupters
- Shaft encoders

PRODUCT SUMMARY			
COMPONENT	I <sub>ra</sub> (μA)	φ (deg)	λ <sub>0.5</sub> (nm)
VEMD2000X01	12	± 15	750 to 1050
VEMD2020X01	12	± 15	750 to 1050

### Note

- Test conditions see table "Basic Characteristics"

ORDERING INFORMATION			
ORDERING CODE	PACKAGING	REMARKS	PACKAGE FORM
VEMD2000X01	Tape and reel	MOQ: 6000 pcs, 6000 pcs/reel	Reverse gullwing
VEMD2020X01	Tape and reel	MOQ: 6000 pcs, 6000 pcs/reel	Gullwing

### Note

- MOQ: minimum order quantity

ABSOLUTE MAXIMUM RATINGS (T <sub>amb</sub> = 25 °C, unless otherwise specified)				
PARAMETER	TEST CONDITION	SYMBOL	VALUE	UNIT
Reverse voltage		V <sub>R</sub>	60	V
Power dissipation	T <sub>amb</sub> ≤ 25 °C	P <sub>V</sub>	215	mW
Junction temperature		T <sub>j</sub>	100	°C
Operating temperature range		T <sub>amb</sub>	- 40 to + 100	°C
Storage temperature range		T <sub>stg</sub>	- 40 to + 100	°C
Soldering temperature	Acc. reflow solder profile fig. 7	T <sub>sd</sub>	260	°C
Thermal resistance junction/ambient	Acc. J-STD-051	R <sub>thJA</sub>	250	K/W



<b>BASIC CHARACTERISTICS</b> ( $T_{amb} = 25\text{ }^{\circ}\text{C}$ , unless otherwise specified)						
PARAMETER	TEST CONDITION	SYMBOL	MIN.	TYP.	MAX.	UNIT
Forward voltage	$I_F = 50\text{ mA}$	$V_F$		1		V
Breakdown voltage	$I_R = 100\text{ }\mu\text{A}$ , $E = 0$	$V_{(BR)}$	32			V
Reverse dark current	$V_R = 10\text{ V}$ , $E = 0$	$I_{ro}$		1	10	nA
Diode capacitance	$V_R = 0\text{ V}$ , $f = 1\text{ MHz}$ , $E = 0$	$C_D$		4		pF
	$V_R = 5\text{ V}$ , $f = 1\text{ MHz}$ , $E = 0$	$C_D$		1.3		pF
Open circuit voltage	$E_e = 1\text{ mW/cm}^2$ , $\lambda = 950\text{ nm}$	$V_o$		350		mV
Temperature coefficient of $V_o$	$E_e = 1\text{ mW/cm}^2$ , $\lambda = 950\text{ nm}$	$TK_{V_o}$		-2.6		mV/K
Short circuit current	$E_e = 1\text{ mW/cm}^2$ , $\lambda = 950\text{ nm}$	$I_k$		11		$\mu\text{A}$
Temperature coefficient of $I_k$	$E_e = 1\text{ mW/cm}^2$ , $\lambda = 950\text{ nm}$	$TK_{I_k}$		0.1		%/K
Reverse light current	$E_e = 1\text{ mW/cm}^2$ , $\lambda = 950\text{ nm}$ , $V_R = 5\text{ V}$	$I_{ra}$	8.5	12	17	$\mu\text{A}$
Angle of half sensitivity		$\phi$		$\pm 15$		deg
Wavelength of peak sensitivity		$\lambda_p$		940		nm
Range of spectral bandwidth		$\lambda_{0.5}$		750 to 1050		nm
Rise time	$V_R = 10\text{ V}$ , $R_L = 1\text{ k}\Omega$ , $\lambda = 820\text{ nm}$	$t_r$		100		ns
Fall time	$V_R = 10\text{ V}$ , $R_L = 1\text{ k}\Omega$ , $\lambda = 820\text{ nm}$	$t_f$		100		ns

**BASIC CHARACTERISTICS** ( $T_{amb} = 25\text{ }^{\circ}\text{C}$ , unless otherwise specified)

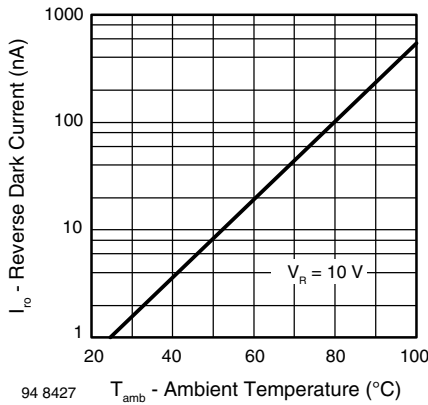

Fig. 1 - Reverse Dark Current vs. Ambient Temperature

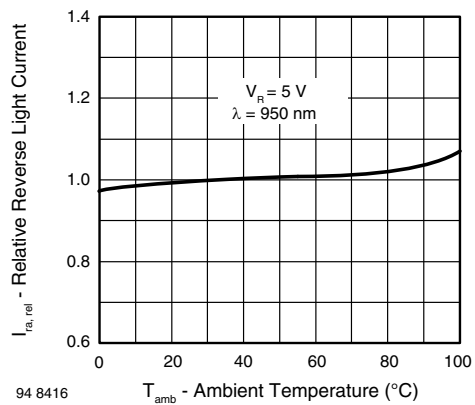

Fig. 2 - Relative Reverse Light Current vs. Ambient Temperature

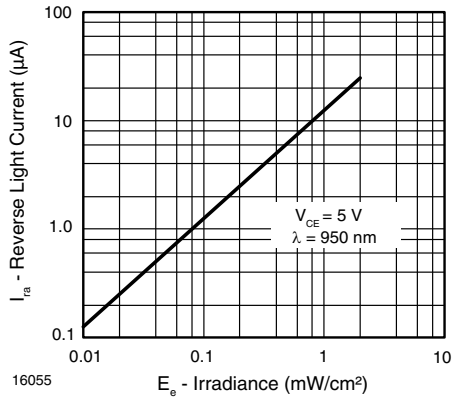

Fig. 3 - Reverse Light Current vs. Irradiance

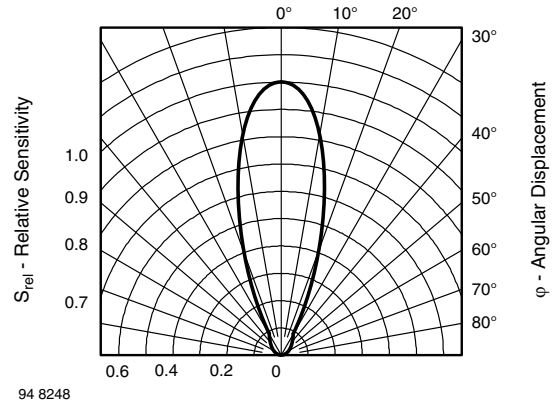

Fig. 6 - Relative Radiant Intensity vs. Angular Displacement

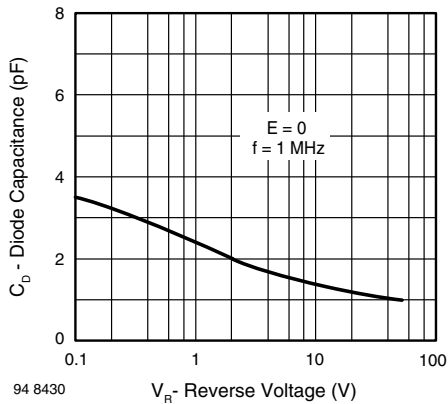

Fig. 4 - Diode Capacitance vs. Reverse Voltage

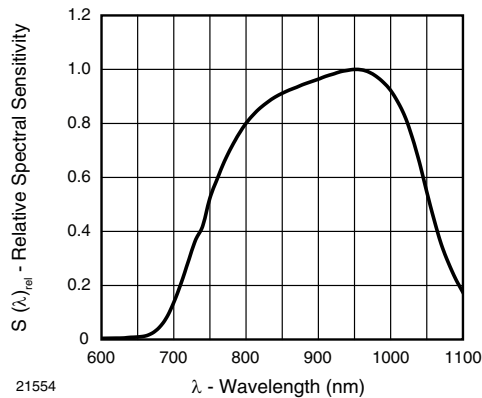

Fig. 5 - Relative Spectral Sensitivity vs. Wavelength

## REFLOW SOLDER PROFILE

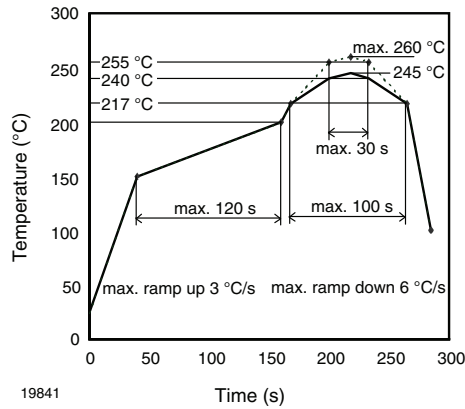

Fig. 7 - Lead (Pb)-free Reflow Solder Profile acc. J-STD-020D

## DRYPACK

Devices are packed in moisture barrier bags (MBB) to prevent the products from moisture absorption during transportation and storage. Each bag contains a desiccant.

## FLOOR LIFE

Floor life (time between soldering and removing from MBB) must not exceed the time indicated on MBB label:

Floor life: 4 weeks

Conditions:  $T_{amb} < 30\text{ °C}$ , RH < 60 %

Moisture sensitivity level 2a, acc. to J-STD-020.

## DRYING

In case of moisture absorption devices should be baked before soldering. Conditions see J-STD-020 or label. Devices taped on reel dry using recommended conditions 192 h at 40 °C (+ 5 °C), RH < 5 %.

## PACKAGE DIMENSIONS in millimeters: VEMD2000

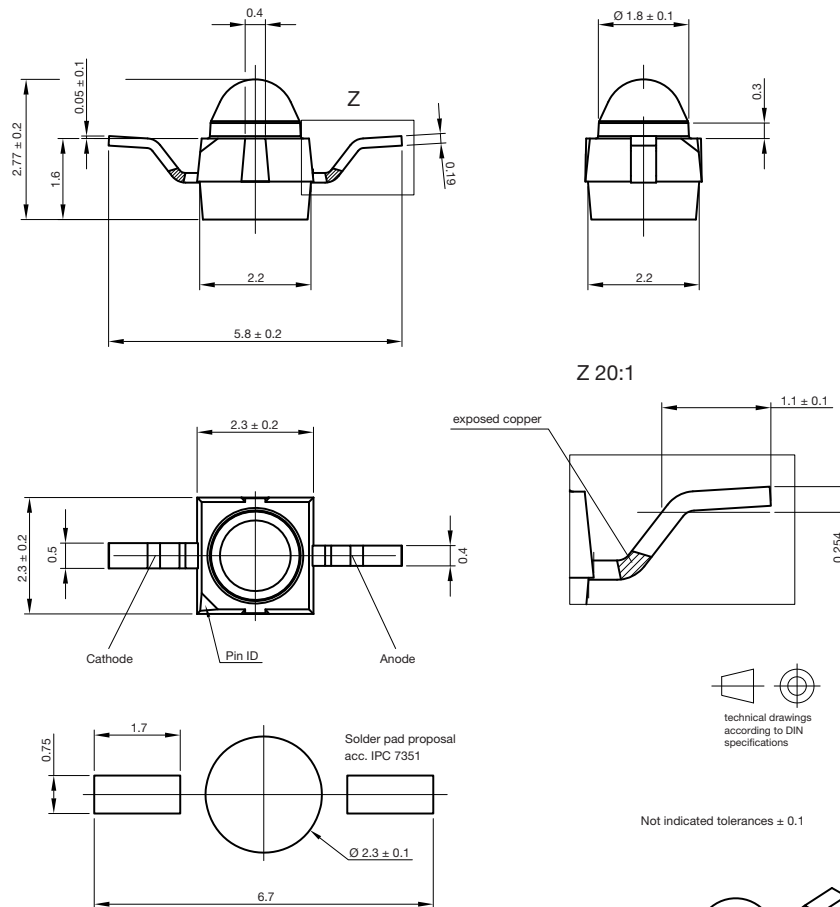

Drawing-No.: 6.544-5391.02-4  
Issue: 2; 18.03.10  
21517

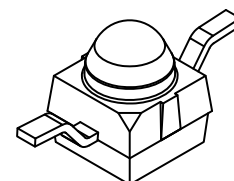



## PACKAGE DIMENSIONS in millimeters: VEMD2020

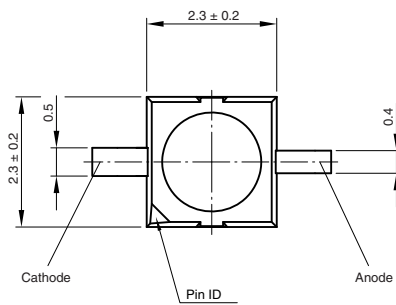
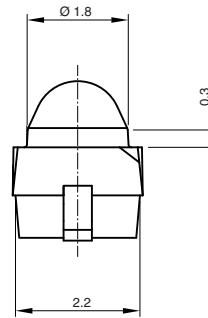
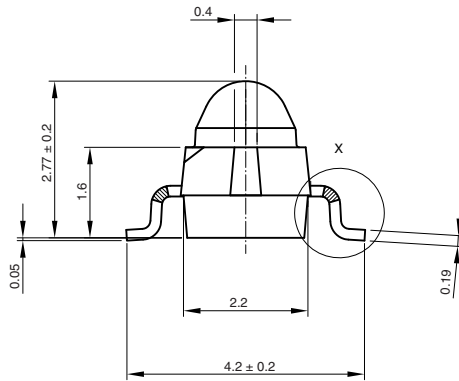

X 20:1

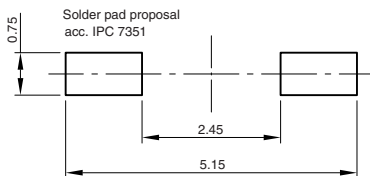
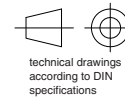
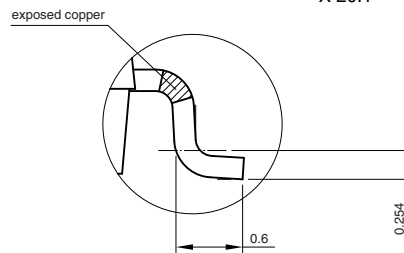

Not indicated tolerances ± 0.1

Drawing-No.: 6.544-5383.02-4  
 Issue: 4; 18.03.10  
 21488

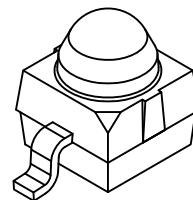



**TAPING AND REEL DIMENSIONS** in millimeters: **VEMD2000**

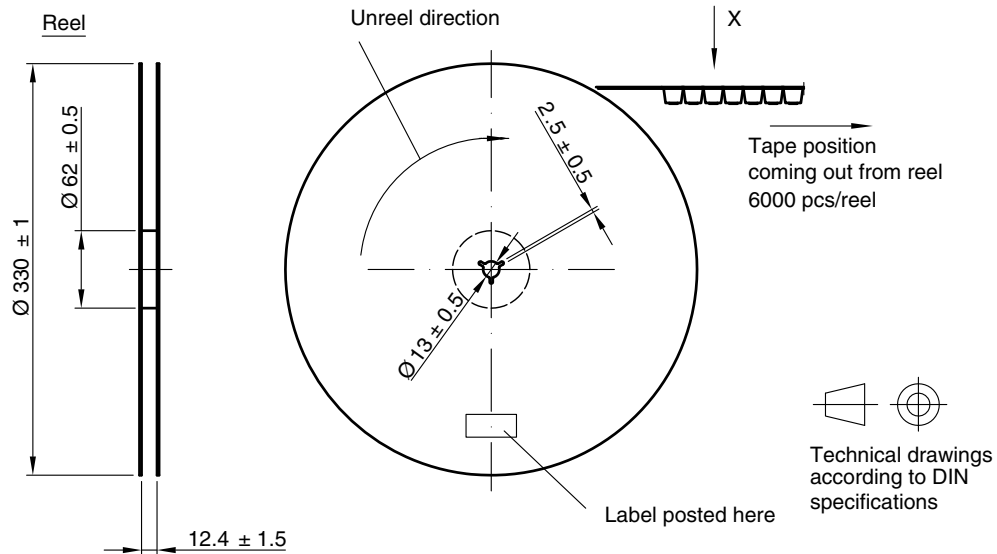

Leader and trailer tape:

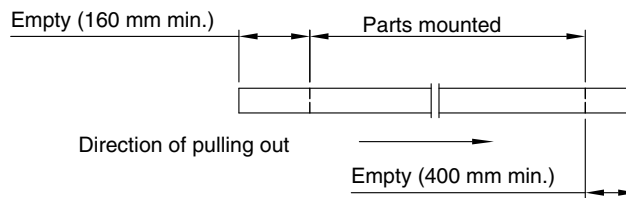

Terminal position in tape

Device	Lead I	Lead II
VEMT2000	Collector	Emitter
VEMT2500		
VEMD2000	Cathode	Anode
VEMD2500		
VSMB2000		
VSMG2000		
VSMY2850RG	Anode	Cathode

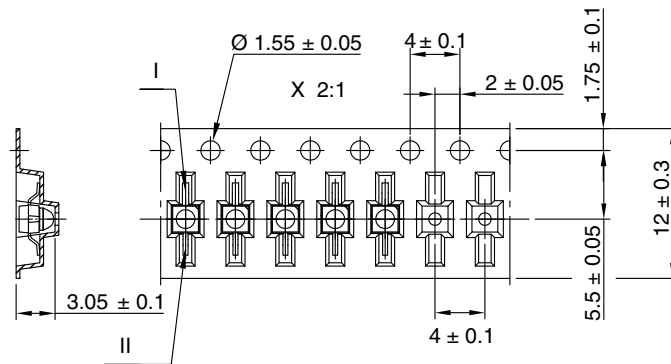

Drawing-No.: 9.800-5100.01-4  
 Issue: 2; 18.03.10  
 21572

## TAPING AND REEL DIMENSIONS in millimeters: VEMD2020

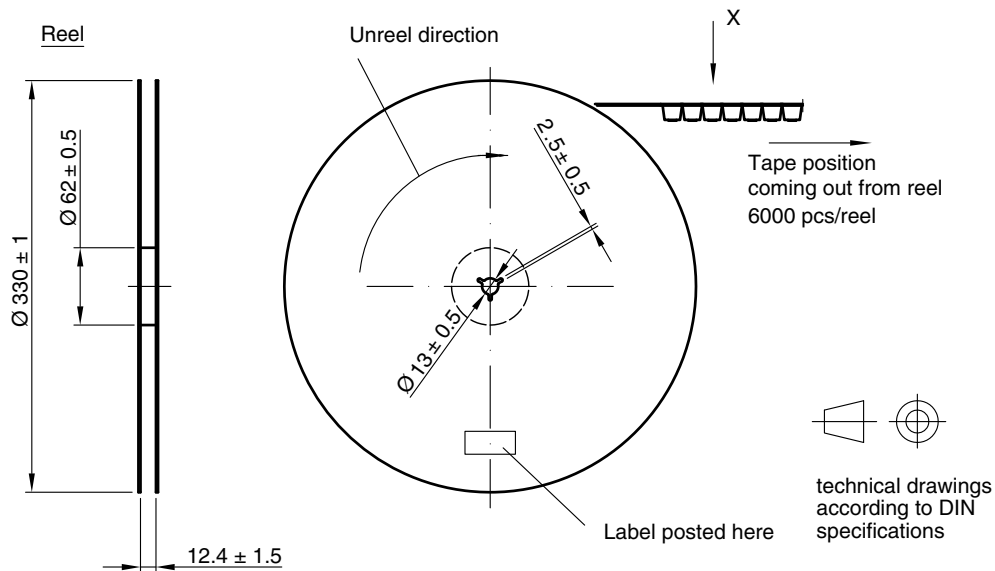

### Leader and trailer tape:

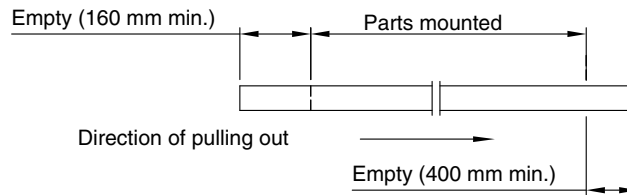

### Terminal position in tape

Device	Lead I	Lead II
VEMT2020	Collector	Emitter
VEMT2520		
VSMB2020	Cathode	Anode
VSMG2020		
VEMD2020		
VEMD2520	Anode	Cathode
VSMY2850G		

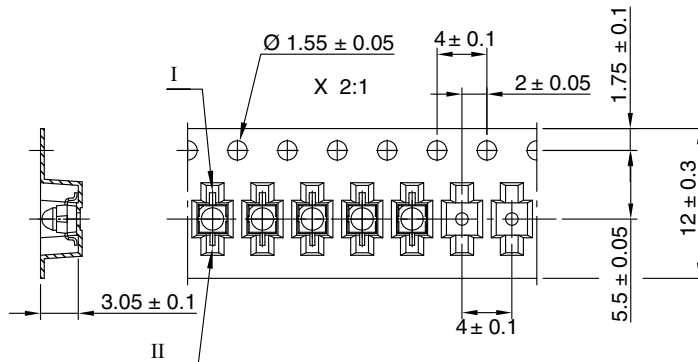

Drawing-No.: 9.800-5091.01-4

Issue: 3; 18.03.10

21571



## **Disclaimer**

ALL PRODUCT, PRODUCT SPECIFICATIONS AND DATA ARE SUBJECT TO CHANGE WITHOUT NOTICE TO IMPROVE RELIABILITY, FUNCTION OR DESIGN OR OTHERWISE.

Vishay Intertechnology, Inc., its affiliates, agents, and employees, and all persons acting on its or their behalf (collectively, "Vishay"), disclaim any and all liability for any errors, inaccuracies or incompleteness contained in any datasheet or in any other disclosure relating to any product.

Vishay makes no warranty, representation or guarantee regarding the suitability of the products for any particular purpose or the continuing production of any product. To the maximum extent permitted by applicable law, Vishay disclaims (i) any and all liability arising out of the application or use of any product, (ii) any and all liability, including without limitation special, consequential or incidental damages, and (iii) any and all implied warranties, including warranties of fitness for particular purpose, non-infringement and merchantability.

Statements regarding the suitability of products for certain types of applications are based on Vishay's knowledge of typical requirements that are often placed on Vishay products in generic applications. Such statements are not binding statements about the suitability of products for a particular application. It is the customer's responsibility to validate that a particular product with the properties described in the product specification is suitable for use in a particular application. Parameters provided in datasheets and / or specifications may vary in different applications and performance may vary over time. All operating parameters, including typical parameters, must be validated for each customer application by the customer's technical experts. Product specifications do not expand or otherwise modify Vishay's terms and conditions of purchase, including but not limited to the warranty expressed therein.

Except as expressly indicated in writing, Vishay products are not designed for use in medical, life-saving, or life-sustaining applications or for any other application in which the failure of the Vishay product could result in personal injury or death. Customers using or selling Vishay products not expressly indicated for use in such applications do so at their own risk. Please contact authorized Vishay personnel to obtain written terms and conditions regarding products designed for such applications.

No license, express or implied, by estoppel or otherwise, to any intellectual property rights is granted by this document or by any conduct of Vishay. Product names and markings noted herein may be trademarks of their respective owners.