



IR Receiver Modules for Remote Control Systems



FEATURES

- Improved dark sensitivity
- Improved immunity against optical noise
- Improved immunity against Wi-Fi noise
- Low supply current
- Photo detector and preamplifier in one package
- Internal filter for PCM frequency
- Supply voltage: 2.5 V to 5.5 V
- Insensitive to supply voltage ripple and noise
- Material categorization: for definitions of compliance please see www.vishay.com/doc?99912



RoHS
COMPLIANT
HALOGEN
FREE
GREEN
(5-2008)

DESIGN SUPPORT TOOLS AVAILABLE



MECHANICAL DATA

Pinning for TSOP18...:

1 = OUT, 2 = GND, 3 = V_S

DESCRIPTION

The TSOP18... series devices are the latest generation miniaturized IR receiver modules for infrared remote control systems. This series provides improvements in sensitivity to remote control signals in dark ambient as well as in sensitivity in the presence of optical disturbances e.g. from CFLs. The robustness against spurious pulses originating from Wi-Fi signals has been enhanced.

The devices contain a PIN diode and a preamplifier assembled on a lead frame. The epoxy package contains an IR filter. The demodulated output signal can be directly connected to a microprocessor for decoding.

The TSOP182.., TSOP184.., and TSOP186.. series devices are designed to receive long burst codes (10 or more carrier cycles per burst). The third digit designates the AGC level (AGC2, AGC4, or AGC6) and the last two digits designate the band-pass frequency (see table below). The higher the AGC, the better noise is suppressed, but the lower the code compatibility. AGC2 provides basic noise suppression, AGC4 provides enhanced noise suppression and AGC6 provides maximized noise suppression. Generally, we advise to select the highest AGC that satisfactorily receives the desired remote code.

These components have not been qualified to automotive specifications.

PARTS TABLE					
AGC		BASIC NOISE SUPPRESSION (AGC2)	ENHANCED NOISE SUPPRESSION (AGC4)	MAXIMIZED NOISE SUPPRESSION (AGC6)	
Carrier frequency	30 kHz	TSOP18230	TSOP18430	TSOP18630	
	33 kHz	TSOP18233	TSOP18433	TSOP18633	
	36 kHz	TSOP18236	TSOP18436 ⁽²⁾⁽⁵⁾⁽⁷⁾	TSOP18636 ⁽⁶⁾	
	38 kHz	TSOP18238	TSOP18438 ⁽³⁾⁽¹⁰⁾⁽¹¹⁾	TSOP18638 ⁽⁴⁾	
	40 kHz	TSOP18240 ⁽¹²⁾	TSOP18440	TSOP18640	
	56 kHz	TSOP18256 ⁽¹⁾	TSOP18456 ⁽⁹⁾	TSOP18656 ⁽⁸⁾	
Package		Minicast			
Pinning		1 = OUT, 2 = GND, 3 = V _S			
Dimensions (mm)		5.0 W x 6.95 H x 4.8 D			
Mounting		Leaded			
Application		Remote control			
Best choice for		⁽¹⁾ Cisco ⁽²⁾ MCIR ⁽³⁾ Mitsubishi ⁽⁴⁾ NEC ⁽⁵⁾ Panasonic ⁽⁶⁾ RC-5 ⁽⁷⁾ RC-6 ⁽⁸⁾ RCA ⁽⁹⁾ r-step ⁽¹⁰⁾ Sejin 4PPM ⁽¹¹⁾ Sharp ⁽¹²⁾ Sony			

Note

- 30 kHz and 33 kHz only available on written request

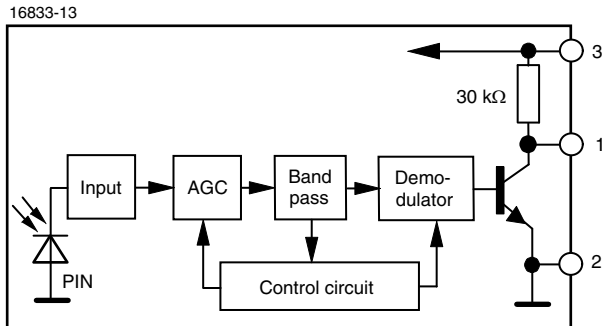
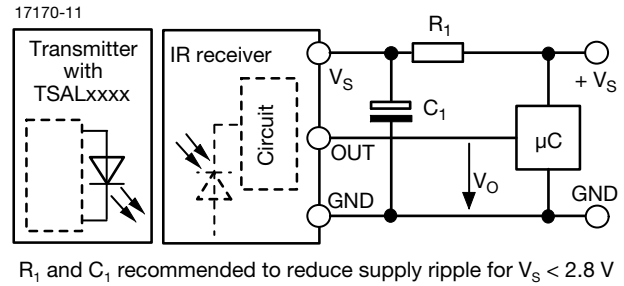
BLOCK DIAGRAM

APPLICATION CIRCUIT

ABSOLUTE MAXIMUM RATINGS

PARAMETER	TEST CONDITION	SYMBOL	VALUE	UNIT
Supply voltage		V_S	-0.3 to +6	V
Supply current		I_S	3	mA
Output voltage		V_O	-0.3 to $(V_S + 0.3)$	V
Output current		I_O	5	mA
Junction temperature		T_j	100	°C
Storage temperature range		T_{stg}	-25 to +85	°C
Operating temperature range		T_{amb}	-25 to +85	°C
Power consumption	$T_{amb} \leq 85$ °C	P_{tot}	10	mW
Soldering temperature	$t \leq 10$ s, 1 mm from case	T_{sd}	260	°C

Note

- Stresses beyond those listed under “Absolute Maximum Ratings” may cause permanent damage to the device. This is a stress rating only and functional operation of the device at these or any other conditions beyond those indicated in the operational sections of this specification is not implied. Exposure to absolute maximum rating conditions for extended periods may affect the device reliability

ELECTRICAL AND OPTICAL CHARACTERISTICS ($T_{amb} = 25$ °C, unless otherwise specified)

PARAMETER	TEST CONDITION	SYMBOL	MIN.	TYP.	MAX.	UNIT
Supply current	$E_v = 0, V_S = 3.3$ V	I_{SD}	0.55	0.70	0.90	mA
	$E_v = 40$ klx, sunlight	I_{SH}	-	0.80	-	mA
Supply voltage		V_S	2.5	-	5.5	V
Transmission distance	$E_v = 0$, test signal see Fig. 1, IR diode TSAL6200, $I_F = 50$ mA	d	-	24	-	m
Output voltage low	$I_{OSL} = 0.5$ mA, $E_e = 0.7$ mW/m ² , test signal see Fig. 1	V_{OSL}	-	-	100	mV
Minimum irradiance	Pulse width tolerance: $t_{pi} - 3.5/f_0 < t_{po} < t_{pi} + 3.5/f_0$, test signal see Fig. 1	E_e min.	-	0.12	0.25	mW/m ²
Maximum irradiance	$t_{pi} - 3.5/f_0 < t_{po} < t_{pi} + 3.5/f_0$, test signal see Fig. 1	E_e max.	30	-	-	W/m ²
Directivity	Angle of half transmission distance	$\phi_{1/2}$	-	± 45	-	°

TYPICAL CHARACTERISTICS ($T_{amb} = 25\text{ }^{\circ}\text{C}$, unless otherwise specified)

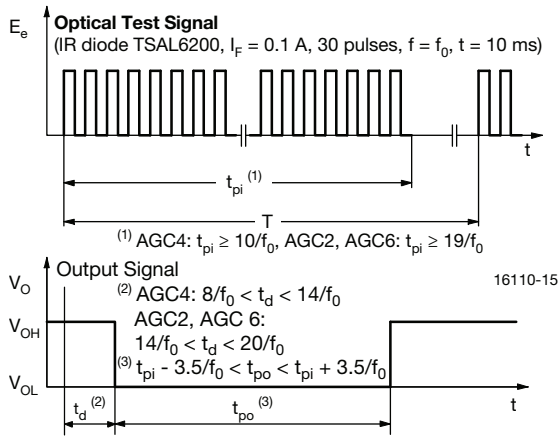

Fig. 1 - Output Delay and Pulse-Width

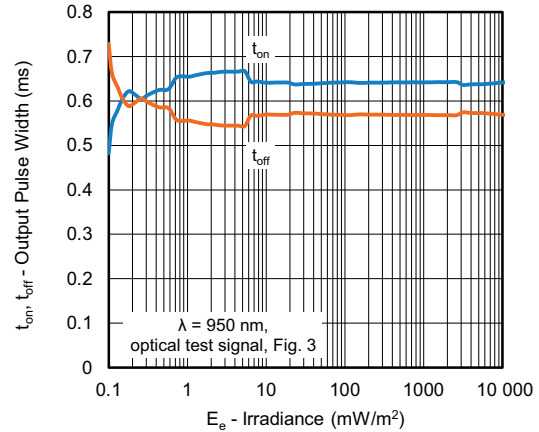

Fig. 4 - Pulse-Width vs. Irradiance in Dark Ambient

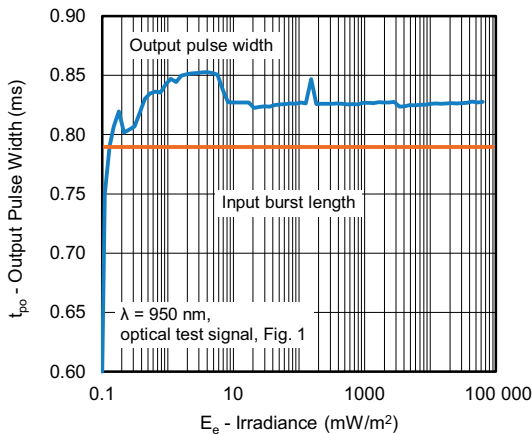

Fig. 2 - Pulse-Width vs. Irradiance in Dark Ambient

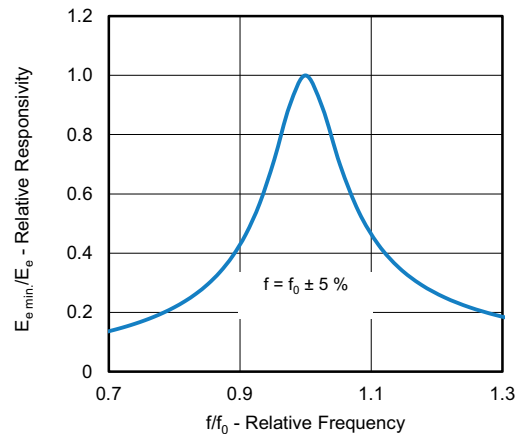

Fig. 5 - Frequency Dependence of Responsivity

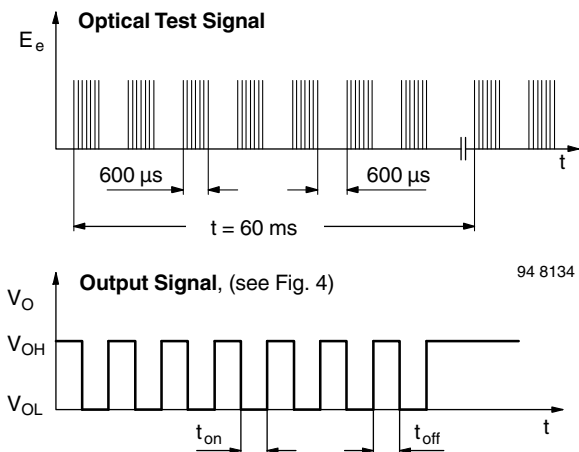

Fig. 3 - Test Signal

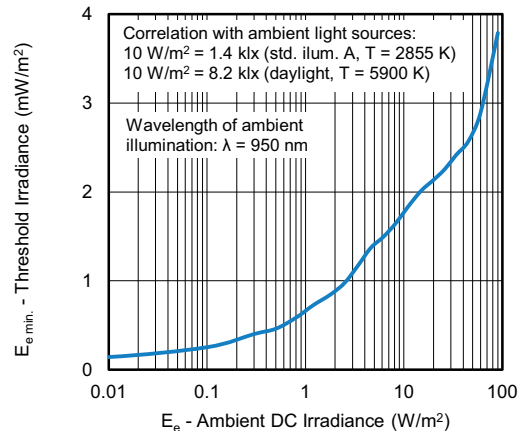

Fig. 6 - Sensitivity in Bright Ambient

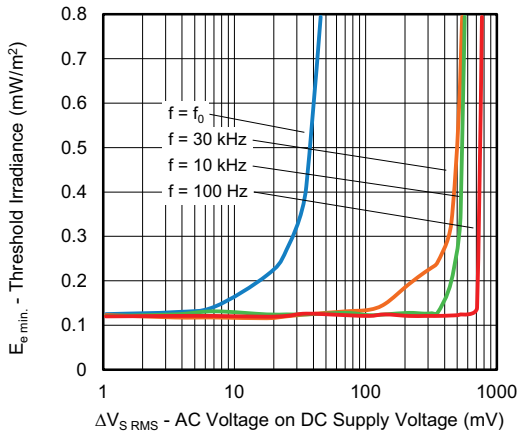

Fig. 7 - Sensitivity vs. Supply Voltage Disturbances

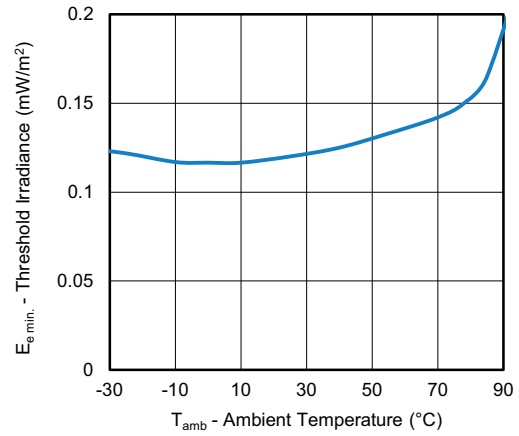

Fig. 9 - Sensitivity vs. Ambient Temperature

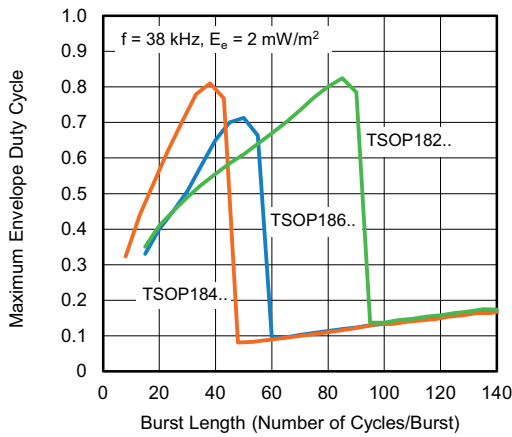

Fig. 8 - Max. Envelope Duty Cycle vs. Burst Length

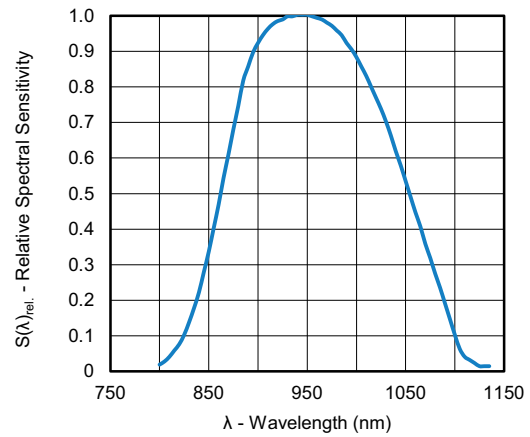

Fig. 10 - Relative Spectral Sensitivity vs. Wavelength

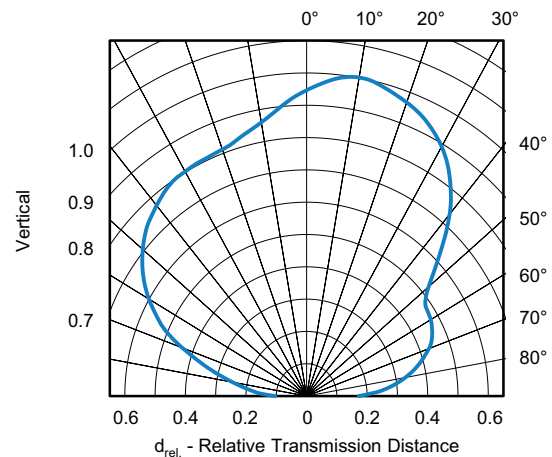
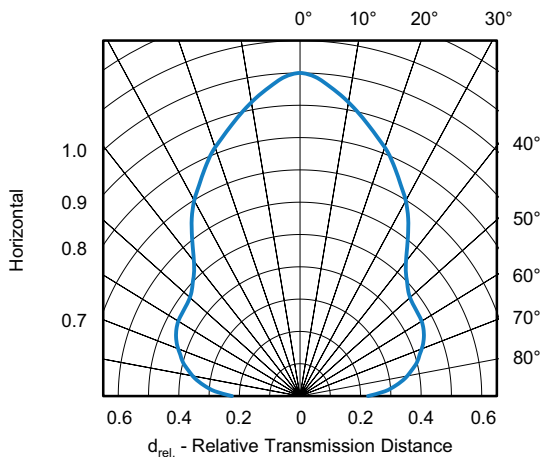

Fig. 11 - Horizontal and Vertical Directivity

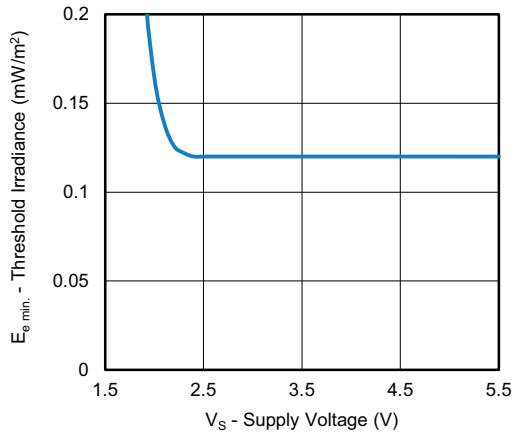

Fig. 12 - Sensitivity vs. Supply Voltage

SUITABLE DATA FORMAT

This series is designed to suppress spurious output pulses due to noise or disturbance signals. The devices can distinguish data signals from noise due to differences in frequency, burst length, and envelope duty cycle. The data signal should be close to the device's band-pass center frequency (e.g. 38 kHz) and fulfill the conditions in the table below.

When a data signal is applied to the product in the presence of a disturbance, the sensitivity of the receiver is automatically reduced by the AGC to insure that no spurious pulses are present at the receiver's output.

Some examples which are suppressed are:

- DC light (e.g. from tungsten bulbs sunlight)
- Continuous signals at any frequency
- Strongly or weakly modulated patterns from fluorescent lamps with electronic ballasts (see Fig. 13 or Fig. 14)
- 2.4 GHz and 5 GHz Wi-Fi

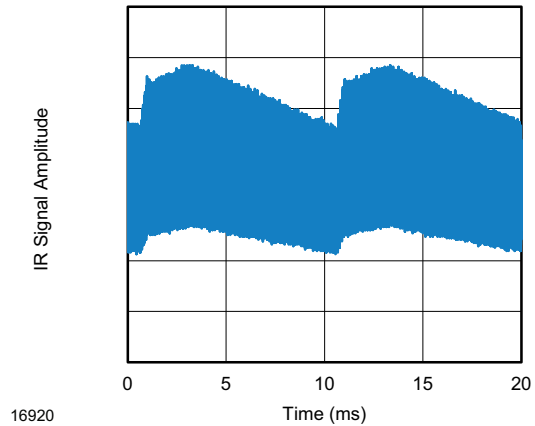

Fig. 13 - IR Disturbance from Fluorescent Lamp With Low Modulation

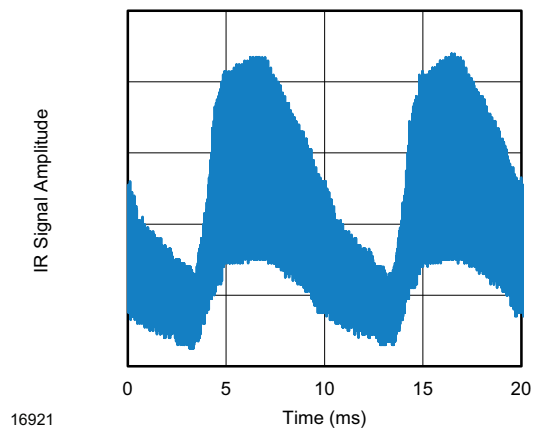

Fig. 14 - IR Disturbance from Fluorescent Lamp With High Modulation

	TSOP182..	TSOP184..	TSOP186..
Minimum burst length	19 cycles/burst	10 cycles/burst	19 cycles/burst
After each burst of length a minimum gap time is required of	19 to 85 cycles ≥ 19 cycles	10 to 40 cycles ≥ 12 cycles	19 to 50 cycles ≥ 19 cycles
For bursts greater than a minimum gap time in the data stream is needed of	85 cycles > 6 x burst length	40 cycles > 10 x burst length	50 cycles > 10 x burst length
Maximum number of continuous short bursts/second	800	1300	800
RC-5 code	Yes	Preferred	Preferred
RC-6 code	Yes	Preferred	Yes
NEC code	Yes	Preferred	Yes
r-step code	Yes	Preferred	Yes
Sony code	Preferred	No	No
RCA 56 kHz code	Yes	Yes	Preferred
Suppression of interference from fluorescent lamps	Fig. 13	Fig. 13 and Fig. 14	Fig. 13 and Fig. 14

Note

- For data formats with short bursts please see the datasheet for TSOP181.., TSOP183.., TSOP185..



PACKAGE DIMENSIONS in millimeters

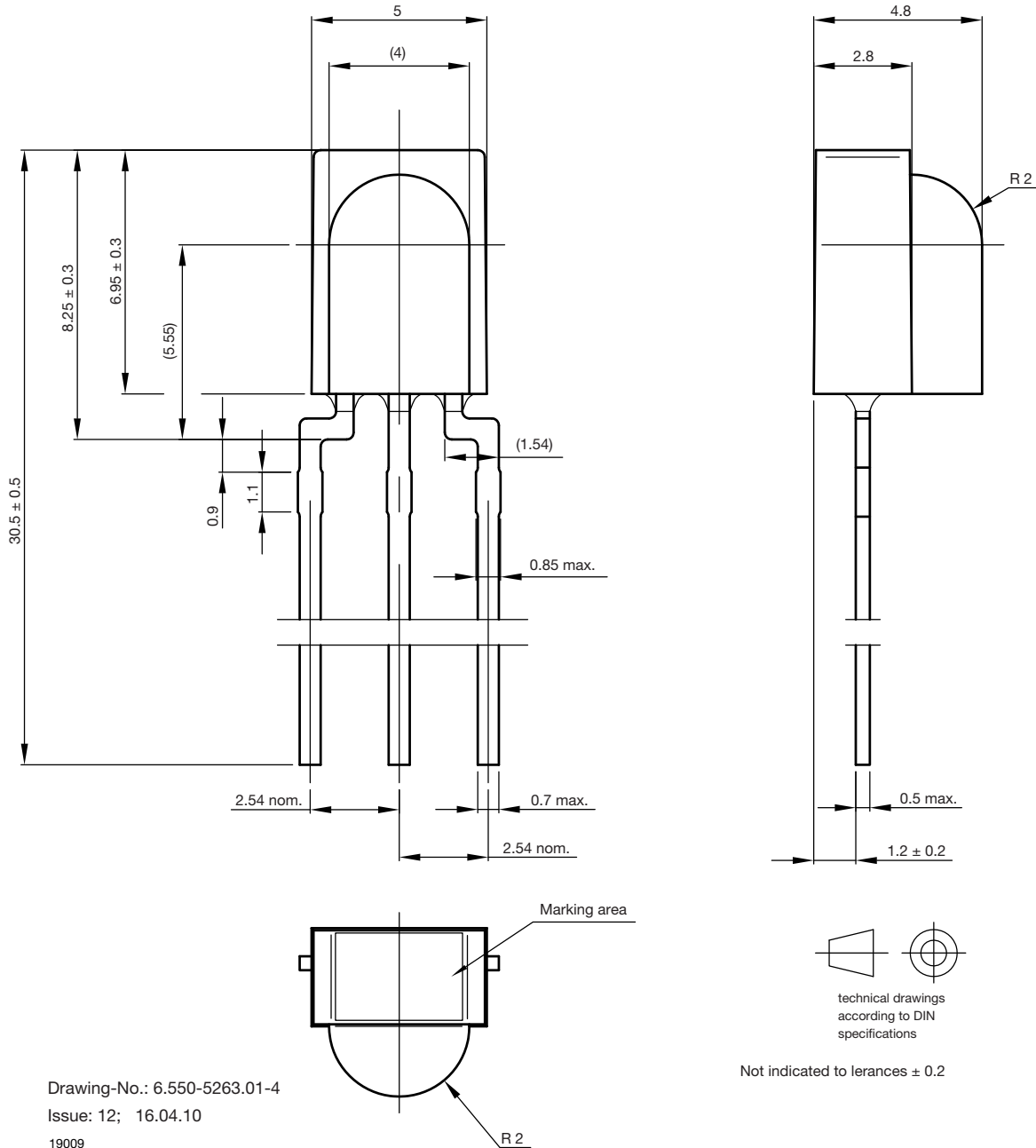



Disclaimer

ALL PRODUCT, PRODUCT SPECIFICATIONS AND DATA ARE SUBJECT TO CHANGE WITHOUT NOTICE TO IMPROVE RELIABILITY, FUNCTION OR DESIGN OR OTHERWISE.

Vishay Intertechnology, Inc., its affiliates, agents, and employees, and all persons acting on its or their behalf (collectively, "Vishay"), disclaim any and all liability for any errors, inaccuracies or incompleteness contained in any datasheet or in any other disclosure relating to any product.

Vishay makes no warranty, representation or guarantee regarding the suitability of the products for any particular purpose or the continuing production of any product. To the maximum extent permitted by applicable law, Vishay disclaims (i) any and all liability arising out of the application or use of any product, (ii) any and all liability, including without limitation special, consequential or incidental damages, and (iii) any and all implied warranties, including warranties of fitness for particular purpose, non-infringement and merchantability.

Statements regarding the suitability of products for certain types of applications are based on Vishay's knowledge of typical requirements that are often placed on Vishay products in generic applications. Such statements are not binding statements about the suitability of products for a particular application. It is the customer's responsibility to validate that a particular product with the properties described in the product specification is suitable for use in a particular application. Parameters provided in datasheets and / or specifications may vary in different applications and performance may vary over time. All operating parameters, including typical parameters, must be validated for each customer application by the customer's technical experts. Product specifications do not expand or otherwise modify Vishay's terms and conditions of purchase, including but not limited to the warranty expressed therein.

Except as expressly indicated in writing, Vishay products are not designed for use in medical, life-saving, or life-sustaining applications or for any other application in which the failure of the Vishay product could result in personal injury or death. Customers using or selling Vishay products not expressly indicated for use in such applications do so at their own risk. Please contact authorized Vishay personnel to obtain written terms and conditions regarding products designed for such applications.

No license, express or implied, by estoppel or otherwise, to any intellectual property rights is granted by this document or by any conduct of Vishay. Product names and markings noted herein may be trademarks of their respective owners.