



VLPC Light Modules



Thank you for choosing the VLPC Light Modules from Vishay. The VLPC Light Modules are designed for integration into luminaires. This application note provides key attributes for design. If you require any further information or support, please contact your sales representative or visit www.vishay.com/leds.

INTRODUCTION

High-power LED technology in common lighting applications provides improvements over incandescent and fluorescent lighting systems. Longer life, lower power consumption, and less light pollution in outdoor applications all favor rapid adoption of LED-based lights. In addition, LEDs have a variety of color temperatures giving light designers the flexibility of using cool or warm lighting similar to colors provided by fluorescent lights.

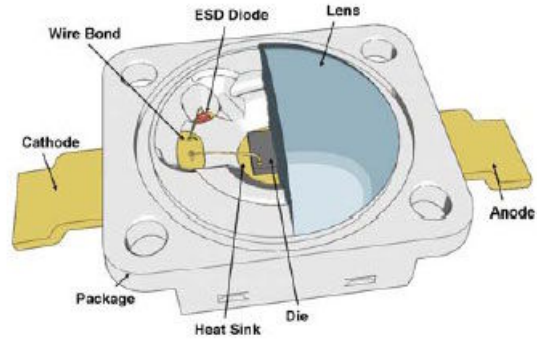
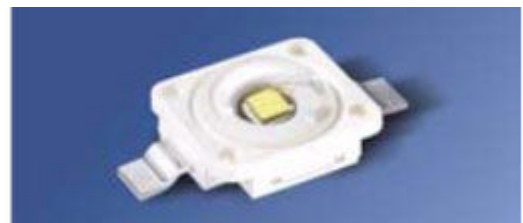

LIGHT SOURCE	LIFE EXPECTANCY (h)
Incandescent (100 W)	750
Compact fluorescent	6000
High bright LED	up to 50 000

COLOR	TEMPERATURE
Warm white	2600 K to 3699 K
Neutral white	3700 K to 4999 K
Cool white	5000 K to 7000 K

LED FOR VLPC LIGHT MODULES

The VLPC Light Modules feature LEDs with cool white color and temperature of 5000 K to 7000 K. The LED is packaged in a plastic package with integrated heat-sink and contacts. The LEDs used are based on the latest semiconductor technology; thin InGaN technology. With thin InGaN, almost all the light is emitted from the surface of the emitter, eliminating typical loss from the sides of more traditional LEDs and boosting the efficiency. In addition, the conversion of the typically blue light is performed via a coating on the surface of the emitter unlike older technologies that depend on the phosphor in the lens. The LED chip is mounted directly on the heat-sink resulting in superbly low thermal resistance of 6 K/W typical, and ensuring a maximum life.

The emission pattern of the LED determines the coverage of area being illuminated. The VLPC Light Modules do not have an associated reflector to change or redirect the light from the LED. In most applications, a simple diffuser is assembled to cover the LEDs for cosmetic purposes. These do not change the characteristics of the emission. The LEDs used in the VLPC Light Modules feature a viewing angle of 170°.

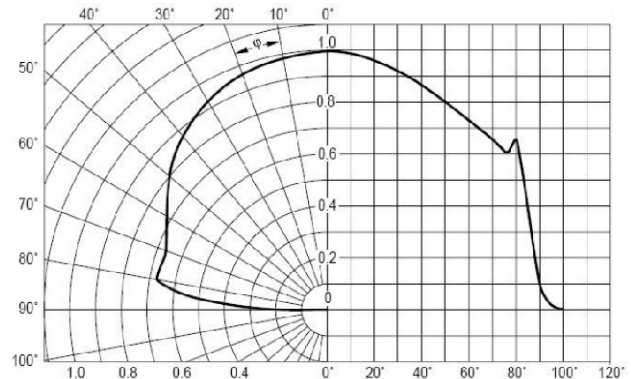



APPLICATION NOTE

VLPC Light Modules

Key Features of LED

- Cool white, color temperature from 5000 K to 7000 K
- Luminous flux of 116 lm at 350 mA and up to 273 lm at 1 A
- Optical efficiency of 146 lm/W at 100 mA
- Technology, ThinGaN
- Long life, 50 000 h
- Color: Cx = 0.31, Cy = 0.32 acc. to CIE 1931 (white)
- ESD-withstand voltage: 8 kV acc. to JESD22-A114-D

VLPC PANELS

PART NUMBER	LUMINOUS FLUX AT I _{FMAX.} (lm)	FORWARD VOLTAGE TYPICAL (V)	DIMENSIONS (mm)	LED	FORWARD CURRENT MAXIMUM (mA)
VLPC0601A2	1050	20	240 x 14	Little Star®	700
					
VLPC1201A2J	2100	42	240 x 14	Little Star®	700
					
VLPC1201A2	2 x 1050	20	120 x 14	Little Star®	700
					

The VLPC portfolio offers a complete range of strip lighting solutions. It is primarily designed for luminaires for indoor use, but can also be used in certain outdoor applications. There are three versions offered which differ by the number

of LEDs on each panel, the pitch, and the size of the panel. The VLPC0601A2 is the VLPC1201A2J sawn in half. The board is shipped to the customer without the jumper connector and the customer will subsequently saw the part.

VLPC Light Modules

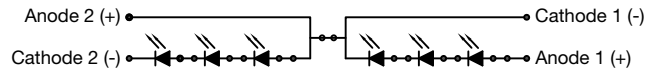
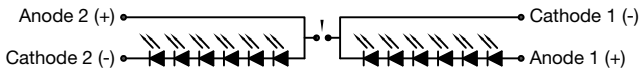
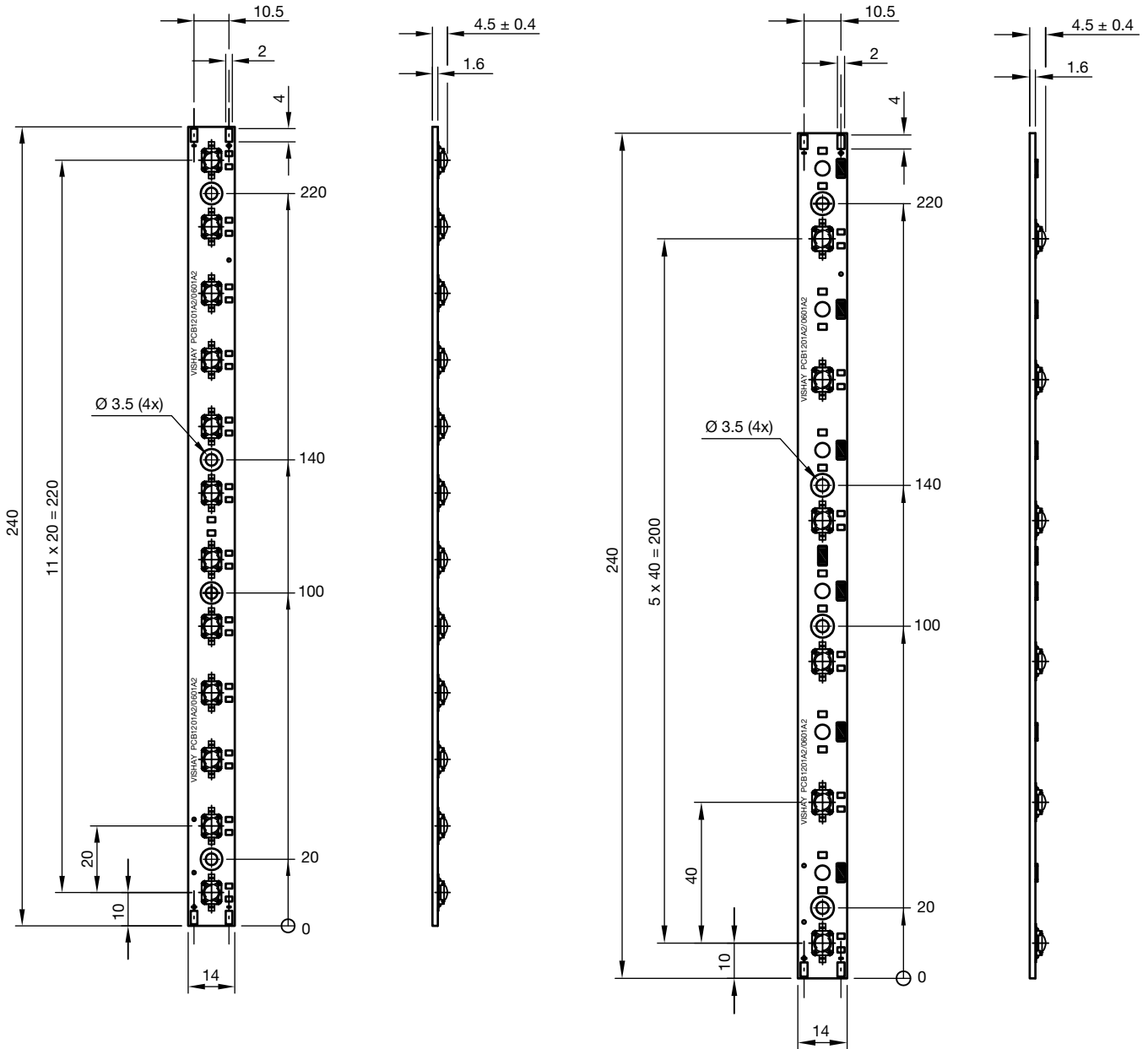

APPLICATION NOTE

VLPC Light Modules

Features

- Metal core PCB: Al > 1 thickness
- Single side, single layer PCB
- Shiny white surface
- 6 or 12 LED's, each with minimum 82 lm at 350 mA each
- Conductive top layer: Cu (min. 18 μm)
- Isolation layer prepreg (100 μm)
- ESD withstand voltage: up to 2 kV according to JESD22-A114-B
- Color binning
- IES LM-80-2008 certified for long-term lumen maintenance
- Compliant to RoHS Directive 2002/95/EC

Benefits

- Three PCB options provide lighting designers with intensity and size flexibility
- Thermal conductive pads in combination with PCB's copper surface and metal core provide awesome heat dissipation

Typical Applications

- Replace fluorescent lights in commercial, industrial and residential applications
- Under cabinet lighting
- Stair lighting
- Sign backlighting
- Automotive interior lighting

THERMAL CHARACTERISTICS

In order to achieve reliability and optimal performance with high-power LEDs, appropriate thermal management is required. Basically, there is a principle limitation on the maximum allowable temperature for the LED - the junction temperature must not exceed 135 °C. In general, the LED heats from two sources: the first source is the existing ambient temperature and the second source is internal current-dependent power losses. As a result, not all operating conditions are appropriate or permissible for a particular ambient temperature. The maximum permissible DC current as a function of ambient temperature is shown in fig. 1.

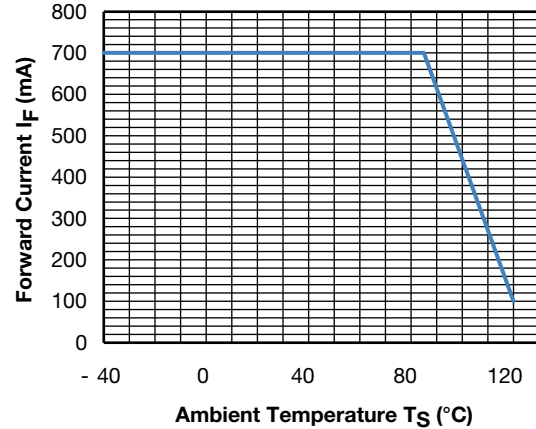

Fig. 1 - Max. Permissible Forward Current for the Individual LED $I_F = f(T_S)$

The maximum permissible junction temperature must not be exceeded since this can lead to irreversible damage and catastrophic failure of the LED. To be on the safe side it is recommended to limit the maximum junction temperature to 120 °C. Due to the underlying physical dependencies with the function of light emitting diodes, a change in the junction temperature T_J within the permissible temperature range has an effect on several LED parameters. The forward voltage, luminous flux, and color coordinates are strongly influenced by the junction temperature, as shown in the next figures. The measurement is done over a short time (< 100 ms), therefore the solder-point temperature is equal to the ambient temperature like using an “infinite” heat-sink. The junction temperature can be calculated: $T_J = T_S + R_{thJS} \times P_{tot}$.

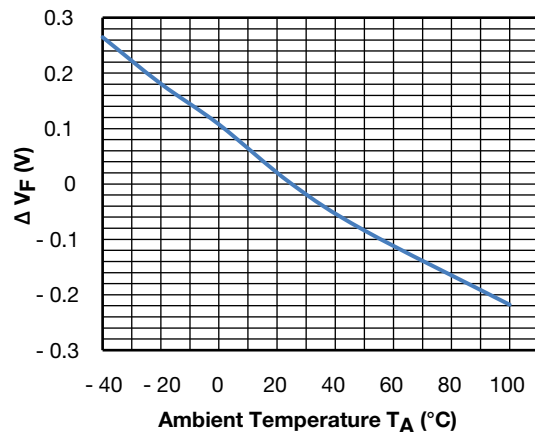

Fig. 2 - ΔV_F Over Ambient Temperature for Single LED $I_F = 350$ mA

VLPC Light Modules

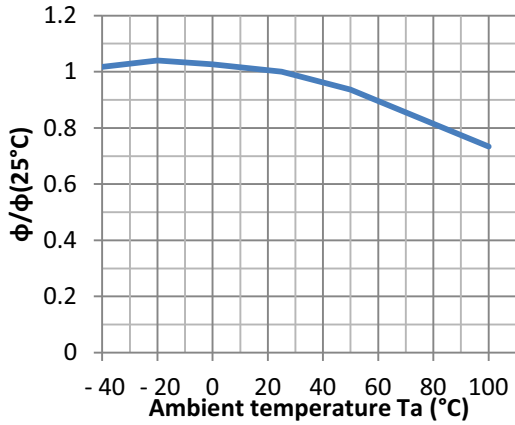

Fig. 3 - Relative Luminous Flux₂₁ $\phi/\phi(25^\circ\text{C}) = f(T_J)$; $I_F = 350\text{ mA}$

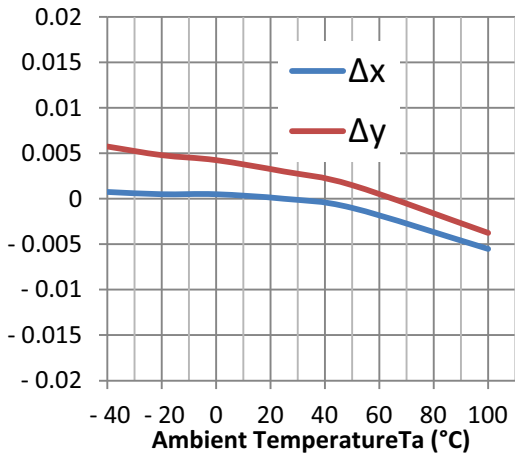

Fig. 4 - Δx , Δy Color Coordinates Drift vs. Ambient Temperature Measured at 350 mA

With increasing temperature and or current, a reduction in lifetime can be observed.

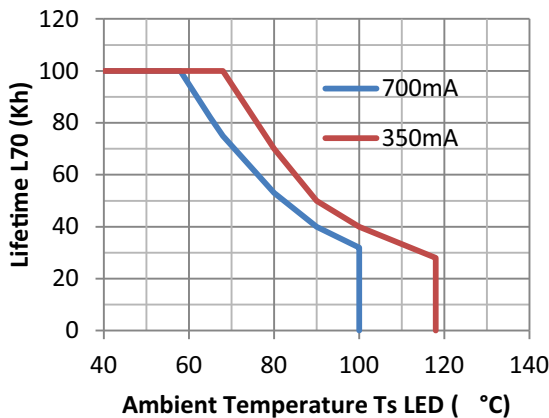

Fig. 5 - Expected Lifetime as a Function of Current and Temperature

The aging process can be divided into 4 phases

- Phase 1: Initial chip aging (positive or negative)
- Phase 2: Reflector aging
- Phase 3: Normal degradation phase
- Phase 4: Chip degradation

The LED, package and attachment to the substrate can be thermally modeled.

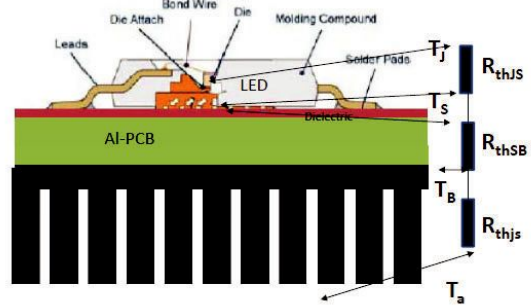

Fig. 6 - Thermal System of an LED Mounted on PCB with Heat-sink

As shown in Fig. 7 the thermal resistance junction to ambient is a summary of the individual parts, junction to solder point, solder point to PCB backside and PCB backside to ambient.

$$R_{thJA} = R_{thJS} + R_{thSB} + R_{thBA}$$

Based on the assumption that the electrical power is dissipated mainly as heat, the junction to ambient thermal resistance can be defined as

$$R_{thJA} = \frac{(T_J - T_A)}{P} = \frac{((\Delta T_J + T_A) - T_A)}{P} = \frac{\Delta T_J}{P}$$

where

$$T_J = \Delta T_J + T_A$$

For power LED's with high efficiency the optical power can be determined by a measurement in an integrating sphere. The value for the power can be corrected accordingly.

The thermal resistance R_{thJS} of the LED and the thermal resistance junction to backside of the PCB can be measured by the V_F method using an "infinite" heatsink. The thermal resistance backside of the PCB to ambient is strongly influenced by the design of the heat-sink and the behavior of the medium of the environment. (active cooling or passive cooling).

For multiple LED's on a PCB the thermal resistance of the board can be calculated similar to Kirchhoff's law for electrical current in parallel circuit.

VLPC Light Modules

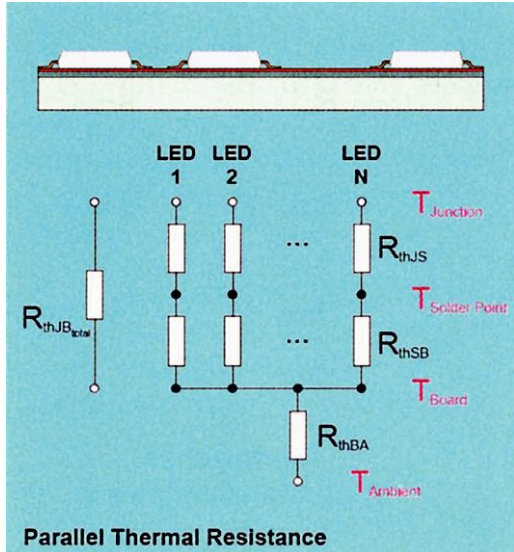

Fig. 7 - Equivalent Circuit Diagram for Thermal Resistance with n LED's on the Board

(Source: J. Krückeberg Hochleistungs LED's)

Thermal resistance for n LED's on one PCB can be described by the following general equation.

$$\frac{1}{R_{ges}} = \sum_{j=1}^n \frac{1}{R_{thj}}$$

n = number of individual LED's

for the thermal resistance junction to backside of the PCB

$$\frac{1}{R_{thJB}} = \sum_{j=1}^n \frac{1}{R_{thJS} + R_{thSB}}$$

If the PCB is assembled with n LED's same power dissipation

$$\frac{1}{R_{thJB}} = \frac{R_{thJS} + R_{thSB}}{n}$$

Finally the total thermal resistance junction to ambient can be calculated as follows

$$R_{thJA} = \frac{(T_J - T_A)}{P} = \frac{((\Delta T_J + T_A) - T_A)}{P} = \frac{\Delta T_J}{P}$$

BINNING

When a wafer of LEDs is fabricated, there is slight variability across the wafer and from wafer to wafer which leads to similarly slight differences in performance of the individual LEDs; luminous flux and color are two such parameters that can vary. In LED production the number of control parameters of the epitaxy process is very large and the process window small, for example, the temperature must be controlled to within 0.5 °C across the wafer at temperatures of ~ 800 °C. To obtain performance consistency for a given application, binning is required. Binning involves characterization of the LEDs by measurement and subsequently categorizing them into several specific bins. Each VLPC Lighting Module panel will be assembled with the same chromaticity group and flux classification group to ensure uniformity.

JUNCTION	THERMAL RESISTANCE
Junction to pin single LED	10 KW
Junction to backside PCB	13 K/W
Junction to backside PCB VLPC1201A2	1.5 K/W

VLPC Light Modules

COLOR RANGE AND COLOR BINNING

VLPC0601A2; VLPC1201A2: 5000 K to 7000 K group 6P to 7R

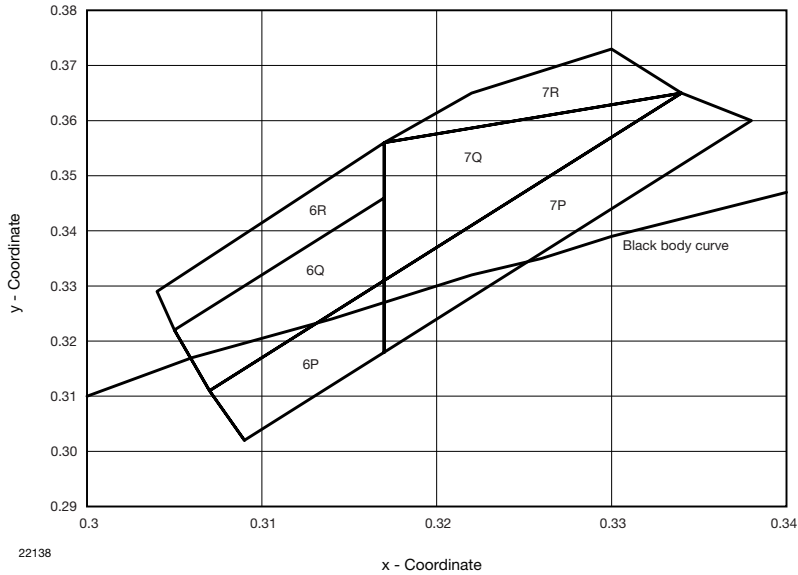

Fig. 8 - Chromaticity Coordinates of Colorgroups

CHROMATICITY COORDINATED GROUPS FOR COOL WHITE SMD LED										
GROUP	X	Y		GROUP	X	Y		GROUP	X	Y
6P	0.309	0.302		6Q	0.307	0.311		6R	0.305	0.322
	0.307	0.311			0.305	0.322			0.304	0.329
	0.317	0.331			0.317	0.346			0.317	0.356
	0.317	0.318			0.317	0.331			0.317	0.346
7P	0.317	0.318		7Q	0.317	0.331		7R	0.317	0.356
	0.317	0.331			0.317	0.356			0.322	0.365
	0.334	0.365			0.334	0.365			0.330	0.373
	0.338	0.360			0.317	0.331			0.334	0.365

LUMINOUS FLUX CLASSIFICATION FOR THE SINGLE LED		
GROUP	LUMINOUS FLUX ϕ_v (lm) CORRELATION TABLE	
	STANDARD	
	MIN.	MAX.
KZ	97 000	112 000
LX	112 000	130 000

APPLICATION NOTE

VLPC Light Modules

DRIVER

VLLDU-1-30W

- Single channel LED driver
- Suitable to drive up to 12 InGaN LEDs in series
- Input voltage: 6 V to 48 V
- Output current: typ. 350 mA or 670 mA selectable via jumper (other output currents can be customized)
- 2 % output current accuracy, typical
- Dimmable via PWM or DC voltage
- Inherent open-circuit LED protection
- Dimensions in mm (l x w x h): 35 x 14 x 6
- PCB material: FR4 with white top-coat lacquer
- 91 % efficiency (LED string with 6 LEDs at 670 mA), typical



TERMINAL PLAN

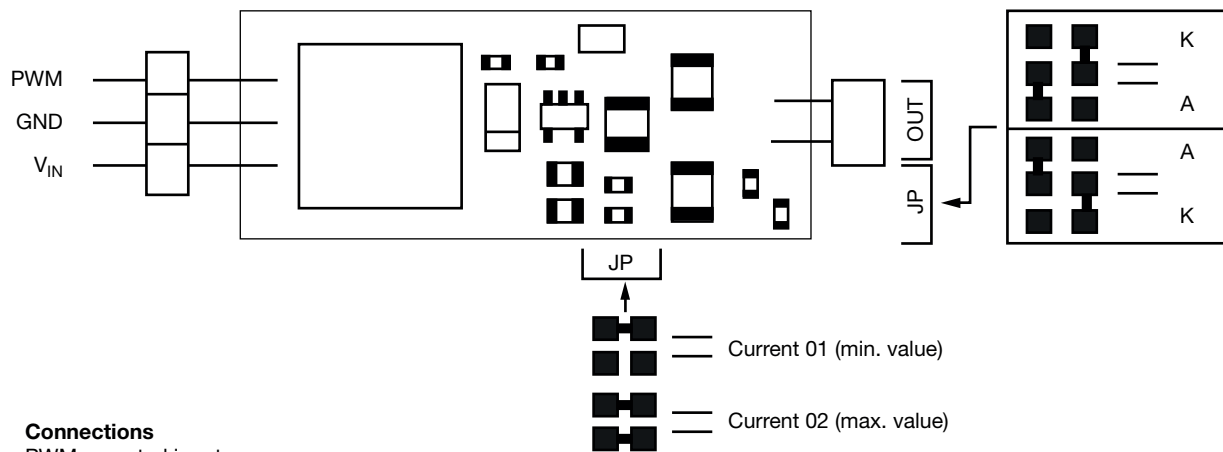

Connections

- PWM = control input
- GND = external ground
- V_{IN} = input voltage
- LED_OUT = LED output (selectable direction)