

Marking on RF Components

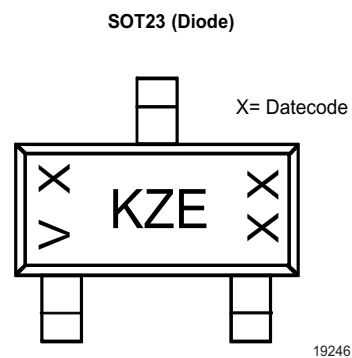

SOT23 (Transistor)

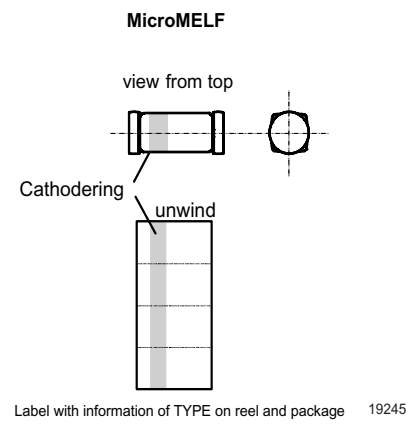
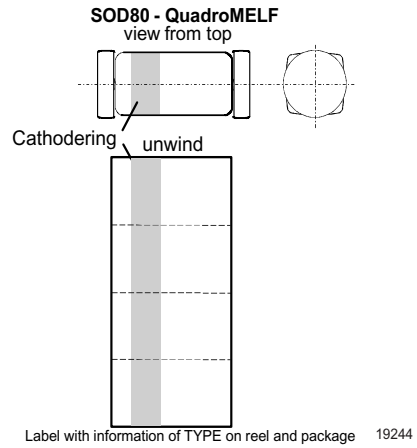
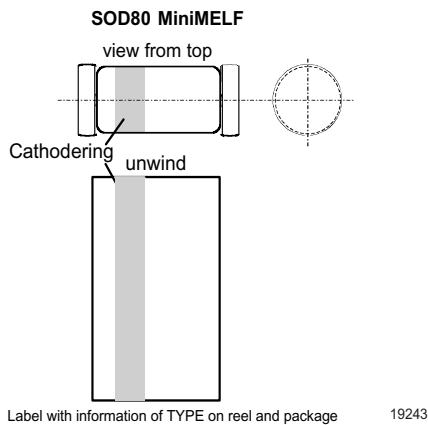
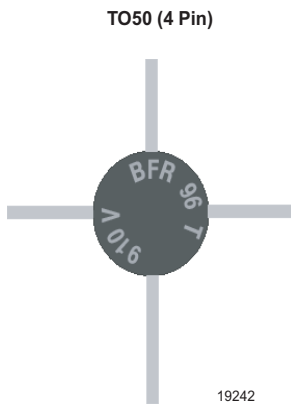
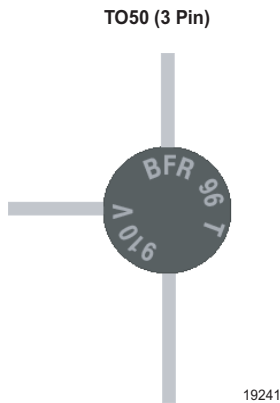
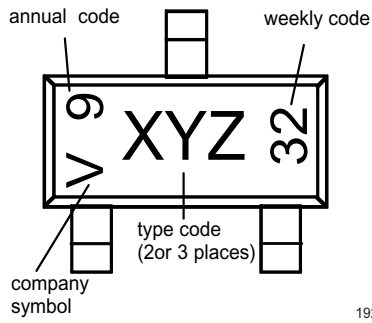

19247

SOT323

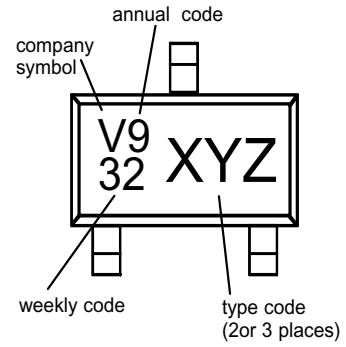

19250

SOT143

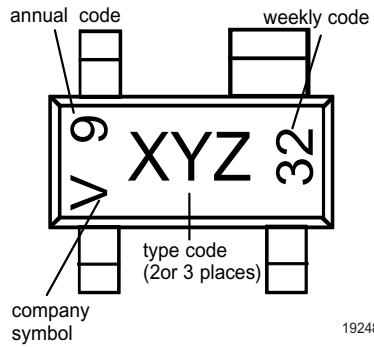

19248

SOT343

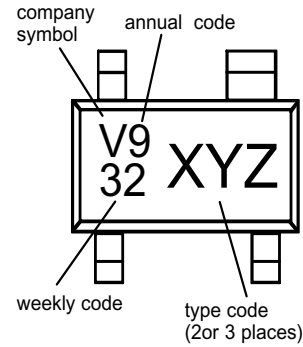

19251

SOT143R

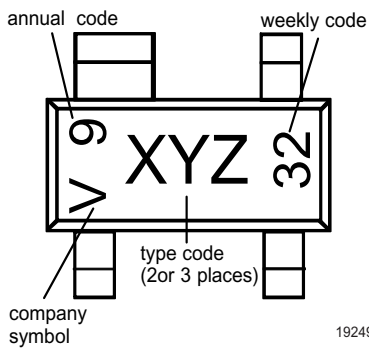

19249

SOT343R

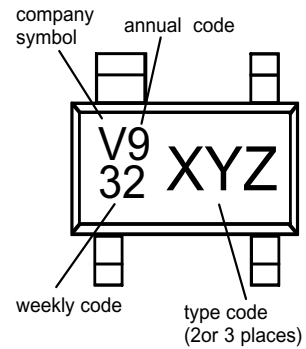

19252

SOT363

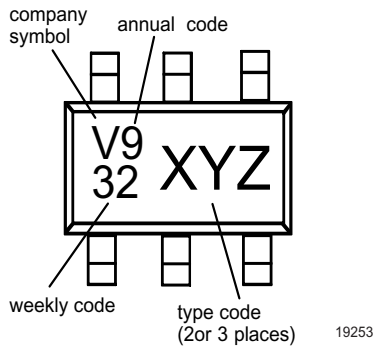

SOT490

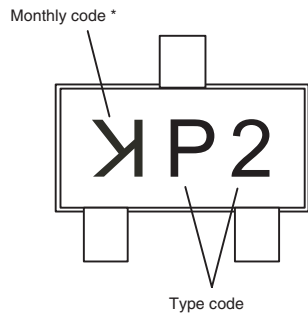

*) According to internal date code table

SOD523

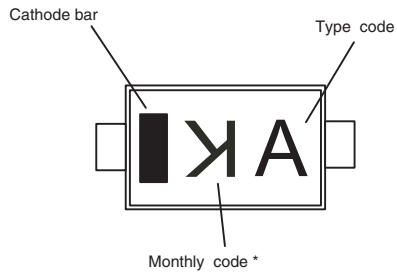

*) According to internal date code table