



Designing the VCNL4020 Into an Application

INTRODUCTION AND BASIC OPERATION

The VCNL4020 is a fully integrated proximity and ambient light sensor. It combines an infrared emitter and PIN photodiode for proximity measurement, ambient light sensor, and signal processing IC in a single package with a 16 bit ADC. The device provides ambient light sensing to support conventional backlight and display brightness auto-adjustment, and proximity sensing to minimize accidental touch input that can lead to call drops and camera launch. With a range of up to 20 cm (7.9"), this stand-alone, single component greatly simplifies the use and design-in of a proximity sensor in consumer and industrial applications because no mechanical barriers are required to optically isolate the emitter from the detector. The VCNL4020 features a miniature leadless package (LLP) for surface mounting in a 4.9 mm x 2.4 mm package with a low profile of 0.83 mm designed specifically for the low height requirements of smart phone, mobile phone, digital camera, and tablet PC applications. Through its standard I²C bus serial digital interface, it allows easy access to a "Proximity Signal" and "Light Intensity" measurements without complex calculations or programming. The programmable interrupt function offers wake-up functionality for the microcontroller when a proximity event or ambient light change occurs which reduces processing overhead by eliminating the need for continuous polling.

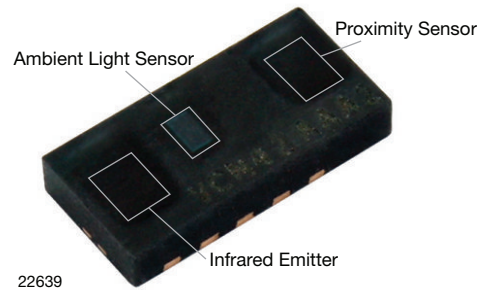

Fig. 1 - VCNL4020 Top View

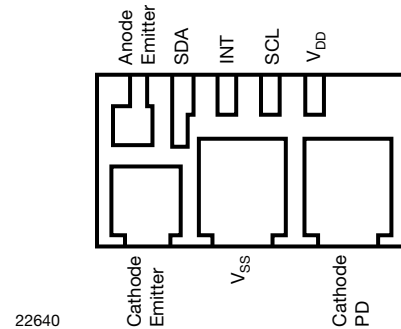

Fig. 2 - VCNL4020 Bottom View

COMPONENTS (BLOCK DIAGRAM)

The major components of the VCNL4020 are shown in the block diagram.

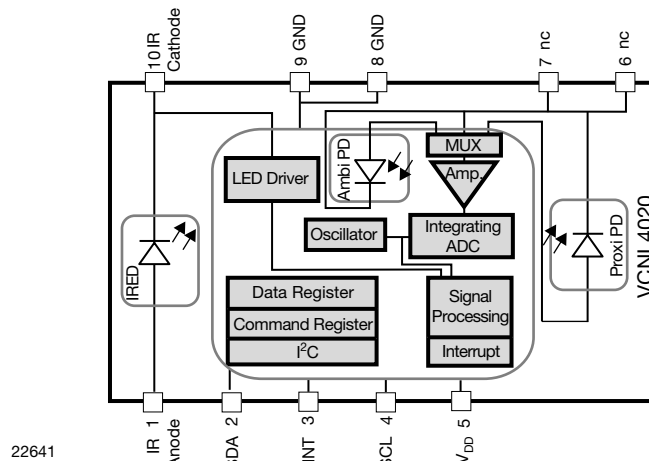

Fig. 3 - VCNL4020 Detailed Block Diagram

Designing the VCNL4020 Into an Application

The integrated **infrared emitter** has a peak wavelength of 890 nm. It emits light that reflects off an object within 20 cm of the sensor. The infrared emitter spectrum is shown in Figure 4.

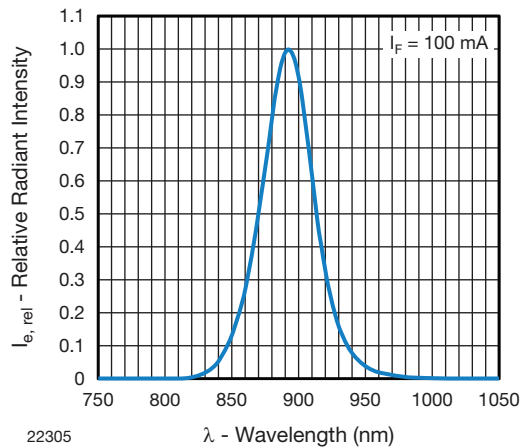

Fig. 4 - Relative Radiant Intensity vs. Wavelength

The infrared emitter has a programmable drive current from 10 mA to 200 mA in 10 mA steps. The infrared light emitted is modulated at one of four user defined carrier frequencies: 390.625 kHz, 781.25 kHz, 1.5625 MHz (not recommended), or 3.125 MHz (not recommended). The PIN photodiode receives the light that is reflected off the object and converts it to a current. It has a peak sensitivity of 890 nm, matching the peak wavelength of the emitter. It is insensitive to ambient light. It ignores the DC component of light and “looks for” the pulsed light at one of the two recommended frequencies used by the emitter. Using a modulated signal for proximity provides distinct advantages over other sensors on the market.

The **ambient light sensor** receives the visible light and converts it to a current. The human eye can see light of wavelengths from 400 nm to 700 nm with a peak of 560 nm.

Vishay’s ambient light sensor closely matches this range of sensitivity. It has peak sensitivity at 540 nm and a bandwidth from 430 nm to 610 nm.

The application specific integrated circuit or ASIC includes an LED driver, I²C bus interface, amplifier, integrating analog to digital converter, oscillator, and Vishay’s “secret sauce” signal processor. For proximity, it converts the current from the PIN photodiode to a 16-bit digital data output value. For ambient light sensing, it converts the current from the ambient light detector, amplifies it and converts it to a 16-bit digital output stream.

PIN CONNECTIONS

Figure 3 shows the pin assignments of the VCNL4020.

The connections include:

- Pin 1 - IR anode to the power supply
- Pin 2 - SDA to microcontroller
- Pin 3 - INT to microcontroller
- Pin 4 - SCL to microcontroller
- Pin 5 - V_{DD} to the power supply
- Pin 6, pin 7 - must not be connected
- Pin 8, pin 9 - connect to ground
- Pin 10 - not connected. Used only if external emitters are being used.

The power supply for the ASIC (V_{DD}) has a defined range from 2.5 V to 3.6 V. The infrared emitter may be connected in the range from 2.5 V to 5.0 V. It is best if V_{DD} is connected to a regulated power supply and pin 1, IR Anode, is connected directly to the battery. This eliminates any influence of the high infrared emitter current pulses on the V_{DD} supply line. The ground pins 8 and 9 are electrically the same. They use the same bottom metal pad and may be routed to the same stable ground plane. The power supply decoupling components shown in Figure 5 are optional. They isolate the sensor from other possible noise on the same power rail but in most applications are not needed. If separate power supplies for the V_{DD} and the infrared emitter are used and there are no negative spikes below 2.5 V, only one capacitor at V_{DD} could be used. The 100 nF capacitor should be placed close to the V_{DD} pin. The SCL and SDA as well as the interrupt lines need pull-up resistors. The resistor values depend on the application and on the I²C bus speed. Common values are about 2.2 kΩ to 4.7 kΩ for the SDA and SCL and 10 kΩ to 100 kΩ for the Interrupt.

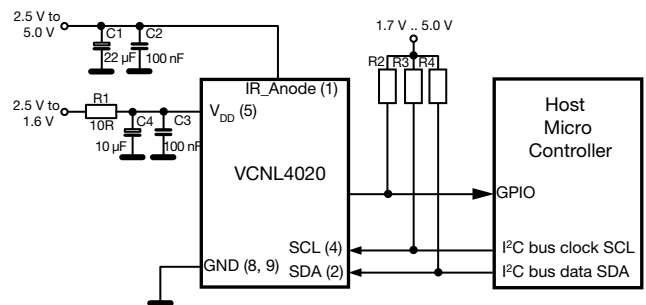

Fig. 5 - VCNL4020 Application Circuit

Designing the VCNL4020 Into an Application

MECHANICAL DESIGN CONSIDERATIONS

The VCNL4020 is a fully integrated proximity and ambient light sensor. Competing sensors use a discrete infrared emitter which leads to complex geometrical calculations to determine the position of the emitter. Competing sensors also require a mechanical barrier between the emitter and detectors to eliminate crosstalk; light reflecting off the inside of the window cover which can produce false proximity readings. The VCNL4020 does not require a mechanical barrier. The signal processor continuously compensates for the light reflected from windows ensuring a proper proximity reading. As a fully integrated sensor, the design process is greatly simplified.

The only dimensions that the design engineer needs to consider are the distance from the top surface of the sensor to the outside surface of the window and the size of the window. These dimensions will determine the size of the detection zone.

The angle of half intensity of the emitter and the angle of half sensitivity of the PIN photodiode are $\pm 55^\circ$ as shown in Fig. 6 and Fig. 7.

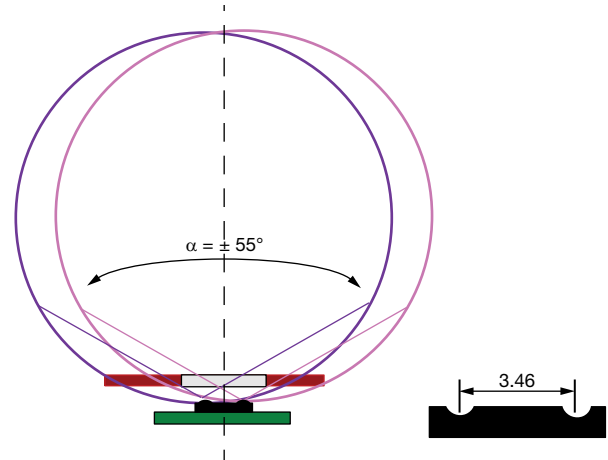

Fig. 8 - Emitter and Detector Angle and Distance

The center of the sensor and center of the window should be aligned. Assuming the detection zone is a cone shaped region with an angle of $\pm 40^\circ$, the following are dimensions for the distance from the top surface of the sensor to the outside surface of the glass, d , and the width of the window, w . The distance from the center of the infrared emitter to the center of the PIN photodiode is 3.46 mm. The height of the sensor is 0.83 mm.

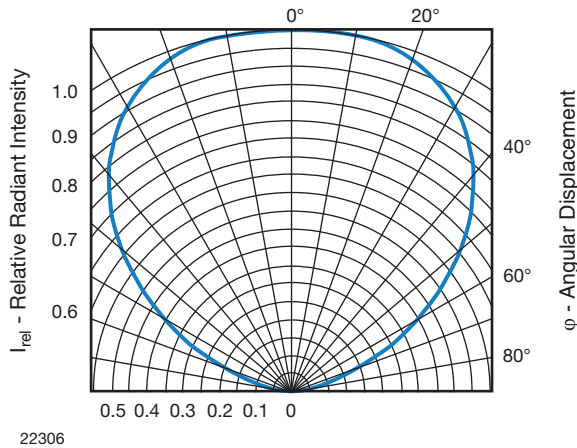

Fig. 6 - Angle of the Half Intensity of the Emitter

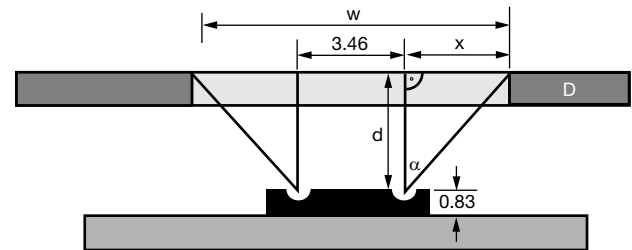

Fig. 9 - Window Dimensions

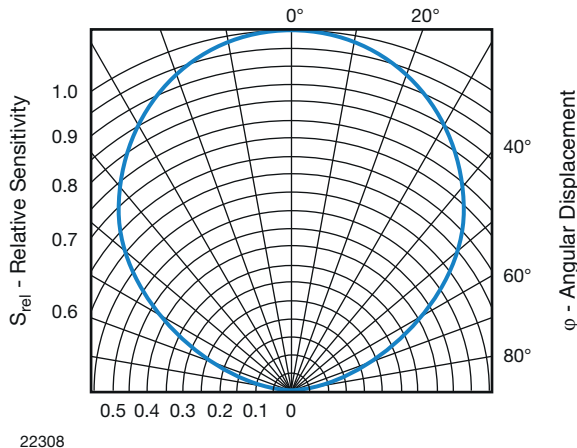

Fig. 7 - Angle of the Half Sensitivity of the PIN Photodiode

d (mm)	x (0.84 d)	w (3.46 + 2 x)
0.5	0.42	4.30
1.0	0.84	5.14
1.5	1.26	6.02
2.0	1.68	6.82
2.5	2.10	7.66
3.0	2.52	8.50

The results above represent the ideal width of the window. The mechanical design of the device may not allow for this size.

Designing the VCNL4020 Into an Application

PROXIMITY SENSOR

The main DC light sources found in the environment are sunlight and tungsten (incandescent) bulbs. These kinds of disturbance sources will cause a DC current in the detector inside the sensor, which in turn will produce noise in the receiver circuit. The negative influence of such DC light can be reduced by optical filtering. Light in the visible range, 400 nm to 700 nm, is completely removed by the use of an optical cut-off filter at 800 nm. With filtering, only longer wavelength radiation above 800 nm can be detected. The PIN photodiode therefore receives only a limited band from the original spectrum of these DC light sources as shown in Fig. 10.

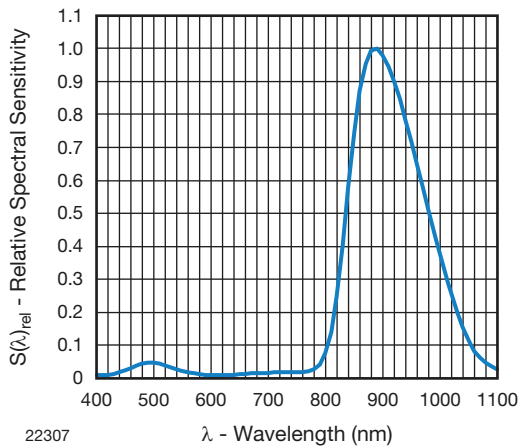

Fig. 10 - Spectral Sensitivity of Proximity PIN Photodiode

As mentioned earlier, the proximity sensor uses a modulated carrier signal on one of four user selected frequencies. These frequencies are far from the ballast frequencies of fluorescent lights ensuring that the sensor is unaffected by them. The infrared emitter sends out a series of pulses, a burst, at the selected frequency and the PIN photodiode which features a band pass filter set to this same frequency, receives the reflected pulses, Fig. 11.

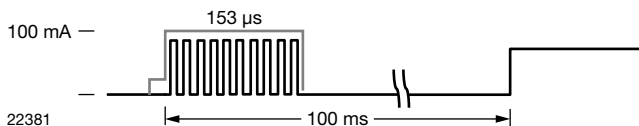
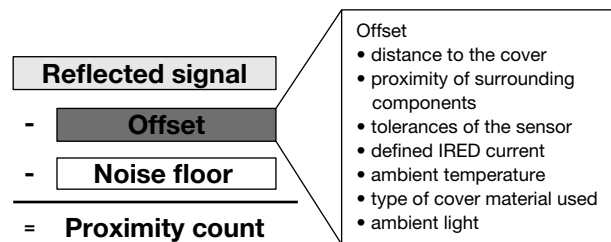

Fig. 11 - Emitter Pulses

In addition to DC light source noise, there is some reflection of the infrared emitted light off the surfaces of the components which surround the VCNL4020. The distance to the cover, proximity of surrounding components, the tolerances of the sensor, the defined infrared emitter current, the ambient temperature, and the type of window material used all contribute to this reflection. The result of the reflection and DC noise produces an output current on

the proximity and light sensing photodiode. This current is converted in to a count called the offset count.

In addition to the offset, there is also a small noise floor during the proximity measurement which comes from the DC light suppression circuitry. This noise is in the range from ± 5 counts to ± 20 counts. The application should “ignore” this offset and small noise floor by subtracting them from the total proximity readings. The application specific offset is easily determined during the development of the end product.



22382

Fig. 12 - Proximity Calculation

Results typically do not need to be averaged. If an object with very low reflectivity or at longer range needs to be detected, the sensor provides a register where the customer can define the number of consecutive measurements above a user-defined threshold before producing an interrupt. This provides stable results without requiring averaging.

PROXIMITY CURRENT COSUMPTION

The current consumption measurement descriptions below refer to the “on demand” mode. The standby current of the VCNL4020 when using “on demand” mode is typically 1.5 μ A. For the “self-timed” mode, there is typically an additional current of 9 μ A being consumed. In this mode, only the I²C interface is active. In most consumer electronic applications the sensor will spend the majority of time in standby mode. For proximity sensing, the current consumption of the VCNL4020 is primarily a function of the infrared emitter current and, secondarily, signal processing done by the ASIC. Example current consumption calculations are shown below for the range of IRED current and measurement rates. The current between burst pulse frames is equivalent to the standby mode. The duty cycle of the emitter is 50 %.

10 measurement per second, emitter current = 100 mA

ASIC: 2.71 mA x 164 μ s x 10/1 s =	4.45 μA
IRED: 100 mA x 153 μ s/1 s x 0.5 x 10/1 s =	76.50 μA
total:	80.95 μA

250 measurement per second, emitter current = 200 mA

ASIC: 2.71 mA x 164 μ s x 250/1 s =	111.0 μA
IRED: 200 mA x 153 μ s x 0.5 x 250/1 s =	3.825 mA
total:	3.936 mA

Designing the VCNL4020 Into an Application

PROXIMITY INITIALIZATION

The VCNL4020 contains seventeen 8-bit registers for operation control, parameter setup and result buffering. All registers are accessible via I²C communication. The built in I²C interface is compatible with all I²C modes: standard, fast and high speed. I²C H-level voltage range is from 1.7 V to 5.0 V.

There are only three registers out of the seventeen that typically need to be defined:

1. IRED Current = 10 mA to 200 mA
IR LED Current Register #3 [83h]
2. Proximity Measurement Rate = 1.95 to 250 meas/s
Proximity Rate Register #2 [82h]
3. Proximity and Light Sensor: Number of consecutive measurements above/below threshold:
 - int_count_exceed = 1 to 128
defines number of consecutive measurements above threshold
 - int_thres_en = 1
enables interrupt when threshold is exceeded
 - int_thres_sel = 0
definines thresholds for proximity
4. **Interrupt Control Register # 9 [89h].**

For ambient light sensing, the default averaging value is 32 measurements. If this value needs to be changed or if “Continuous conversion” mode is desired, a fourth register may be defined:

4. ALS Measurement Rate, auto offset = on, averaging
Ambient Light Parameter Register # 4 [84h]

Fig. 13 shows the typical digital counts output versus distance for three different emitter currents. The reflective reference medium is the Kodak Gray card. This card shows approximately 18 % reflectivity at 890 nm.

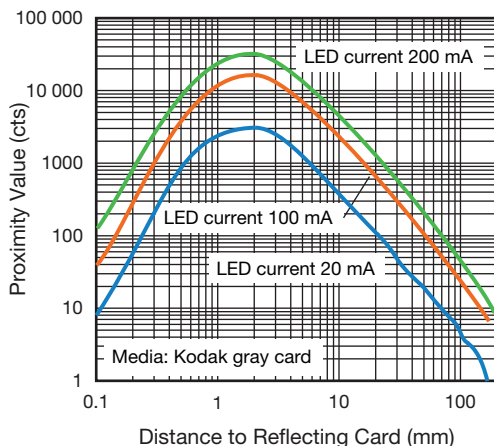

Fig. 13 - Proximity Value vs. Distance

The proximity measurement rate determines how fast the application reacts when an object appears in, or is removed from, the proximity zone. Reaction time is also determined by the number of counts that must be exceeded before an interrupt is set.

To define these register values, evaluation test should be performed. These tests can be made just using the VCNL4020 sensor board together with the SensorXplorer™. Both boards are available from any of Vishay’s distributors, please see:
www.vishay.com/optoelectronics/SensorXplorer.

Timing

For an I²C bus operating at 100 kHz, an 8-bit write or read command plus start, stop and acknowledge bits takes 100 μs. When the device is powered on, the initialization with just these 3 registers needs 3 write commands, each requiring 3 bytes: slave address, register and data.

Power Up

The release of internal reset, the start of the oscillator and signal processor needs **2.5 ms**

Initialize Registers

Write to 3 registers **900 μs**

- IR LED current
- Proximity rate
- Interrupt control

Once the device is powered on and the VCNL4020 initialized, a proximity measurement can be taken. Before the first read out of the proximity count, a wait time is required. Subsequent reads do not require this wait time.

Start measurement	300 μs
Measurement being made	170 μs
Wait time prior to first read	400 μs
Read out of the proximity data	600 μs
Total:	1470 μs

Designing the VCNL4020 Into an Application

AMBIENT LIGHT SENSING

Ambient light sensors are used to detect light or brightness in a manner similar to the human eye. They allow settings to be adjusted automatically in response to changing ambient light conditions. By turning on, turning off, or adjusting features, ambient light sensors can conserve battery power or provide extra safety while eliminating the need for manual adjustments.

Illuminance is the measure of the intensity of light incident on a surface and can be correlated to the brightness perceived by the human eye. In the visible range, it is measured in units called “lux.” Light sources with the same lux measurement appear to be equally bright. In Fig. 14, the incandescent light and sunlight have been scaled to have the same lux measurement. In the infrared region, the intensity of the incandescent light is significantly higher. A standard silicon photodiode is much more sensitive to infrared light than visible light. Using it to measure ambient light will result in serious deviations between the lux measurements of different light sources and human-eye perception. Using Vishay’s ambient light sensors will solve this problem because they are most sensitive to the visible part of the spectrum.

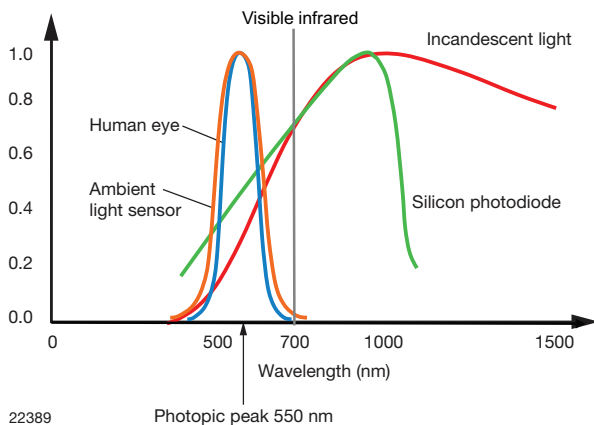

Fig. 14 - Relative Spectral Sensitivity vs. Wavelength

The human eye can see light with wavelengths from 400 nm to 700 nm. The ambient light sensor closely matches this range of sensitivity and provides a digital output based on a 16-bit signal.

AMBIENT LIGHT MEASUREMENT, RESOLUTION AND OFFSET

The ambient light sensors measurement resolution is 0.25 lux/count. The 16-bit digital resolution is equivalent to 65 536 counts. This yields a measurement range from 0.25 lux to 16 383 lux.

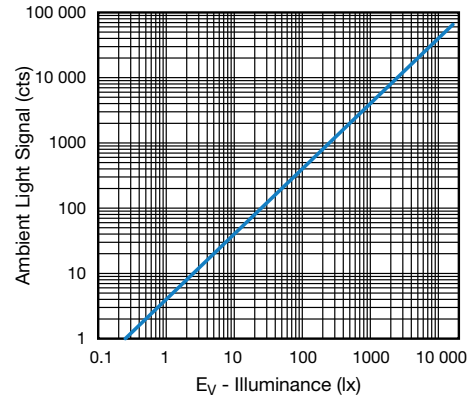

Fig. 15 - Ambient Light Values vs. Illuminance

In most applications a cosmetic window or cover is placed in front of the sensor. These covers reduce the amount of light reaching the sensor. It is not uncommon for only 10 % of the ambient light to pass through the window. The resulting sensor resolution in relation to cover transparency is shown in Table 11.

TABLE 11 - RESOLUTION VS. TRANSPARENCY

COVER VISIBLE LIGHT TRANSPARENCY (%)	RESULTING SENSOR RESOLUTION (LUX/COUNT)
100	0.25
50	0.5
20	1.25
10	2.5

Similar to the proximity measurements, there is a digital offset deviation of -3 counts which has to be considered when setting up the application thresholds. This offset comes from tolerances within the digital compensation process. In single-digit lux ambient lighting where the transparency of the window is 10 % or less these 3 counts should be added to the actual ambient light value.

AMBIENT LIGHT SENSOR CURRENT CONSUMPTION

The current consumption measurement descriptions below refer to the “on demand” mode. The standby current of the VCNL4020 when using “on demand” mode is typically 1.5 μ A. For the “self-timed” mode, there is typically an additional current of 9 μ A being consumed.

The ambient light sensor can operate in single or continuous mode. In single mode operation, an ambient light measurement consists of up to 128 individual measurement cycles which are averaged. The timing diagram for an individual measurement cycle is shown in Fig. 16.

Designing the VCNL4020 Into an Application

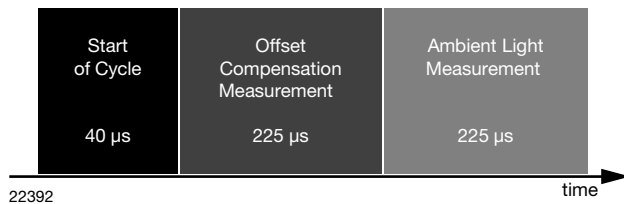

Fig. 16 - Timing Diagram for Individual Measurement Cycle

In single-mode operation, an ambient light measurement takes 100 ms. The single measurement cycles are evenly spread inside this 100 ms frame. Fig. 17 shows an example where 8 single measurement cycles are averaged. The maximum number of single measurement cycles that can be used to calculate an average is 128. The maximum number of times this average can be calculated in one second is 10.

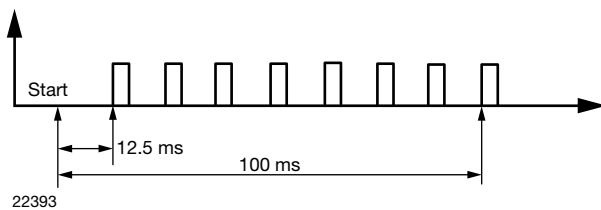

Fig. 17 - Ambient Light Measurement with Averaging = 8

A higher number of measurement cycles increases the accuracy of the reading and reduces the influence of modulated light sources. However, a higher number of cycles also consume more power. During an individual measurement cycle, the ASIC consumes approximately 2.7 mA. Between the individual measurements, the current consumption is 9 μA. Example current consumption calculations are shown below.

Current Calculations for Ambient Light Measurements:

1 measurement per second, AVG = 32

$$2.7 \text{ mA} \times 450 \text{ } \mu\text{s}/1 \text{ cycle} \times 32 \text{ cycles} \times 1 = 39 \text{ } \mu\text{A}$$

10 measurement per second, AVG = 128

$$2.7 \text{ mA} \times 450 \text{ } \mu\text{s}/1 \text{ cycle} \times 128 \text{ cycles} \times 10 = 1.55 \text{ mA}$$

The current consumption for the ambient light sensor is strongly dependent on the number of measurements taken. In single-mode operation, the highest average current is 1.55 mA. Fig. 18 shows that increasing the number of cycles averaged reduces the standard deviation of the measurement.

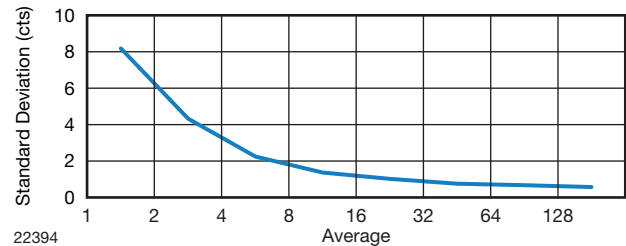

Fig. 18 - Ambient Light Noise vs. Averaging

In continuous conversion mode, the ambient light sensor measurement time can be reduced. A timing example of continuous mode where 8 measurements are averaged is shown in Fig. 19.

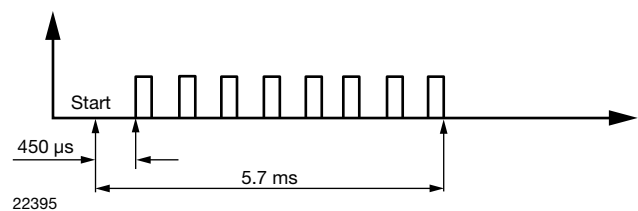

Fig. 19 - Ambient Light Measurement with Averaging = 8 Using Continuous Conversion Mode

The individual measurements are done sequentially. Recall that one individual measurement cycle, including offset compensation, takes approximately 450 μs. The gap time is 180 μs. As shown in Fig. 19, the result of the 8 cycles is already accessible after about 6 ms. However, fluorescent light suppression is less effective in this mode.

There will be no influence on the ambient measurement from the infrared emitter used for proximity because the proximity measurements are made between the ambient light measurements. They are not performed at the same time.

AMBIENT LIGHT INITIALIZATION

For ambient light sensing, only register #4 parameters need to be initialized

- Continuous conversion ON/OFF (register #4b7)
- Offset compensation ON/OFF (register #4b3)
- Number of average measurements (register #4b0 to 4b2)

The default settings are:

- Continuous conversion = OFF
- Offset compensation = ON
- Number of average measurements = 32



Designing the VCNL4020 Into an Application

INTERRUPT

The VCNL4020 features an interrupt function. The interrupt function enables the sensor to work independently until a predefined proximity or ambient light event or threshold occurs. It then sets an interrupt which requires the microcontroller to awaken. This helps customers reduce their software effort, and reduces power consumption by eliminating polling communication traffic between the sensor and microcontroller. The interrupt pin, Pin 3 of the VCNL4020, should be connected to a dedicated GPIO of the controller. A pull-up resistor is added to the same power supply to which the controller is connected. This INT pull-up resistor may be in the range of 1 kΩ to 100 kΩ. Its current sinking capability is greater than 8 mA, typically 10 mA, and less than 20 mA.

The events that can generate an interrupt include:

1. A lower and an upper threshold for the proximity value can be defined. If the proximity value falls below the lower limit or exceeds the upper limit, an interrupt event will be generated. In this case, an interrupt flag bit in the interrupt status register will be set and the interrupt pad of the ASIC will be pulled to low by an open drain pull-down circuit. In order to eliminate false triggering of the interrupt by noise or disturbances, it is possible to define the number of consecutive measurements that have to occur before the interrupt is triggered.
2. A lower and an upper threshold for the ambient light value can be defined. If the ambient light value falls below the lower limit or exceeds the upper limit, an interrupt event will be generated. There is only one set of high and low threshold registers. You will have to decide if the thresholds will be defined for proximity or ambient light.
3. An interrupt can be generated when a proximity measurement is ready.
4. An interrupt can be generated when an ambient light measurement is ready.

For each of these conditions a separate bit can activate or deactivate the interrupt. This means that a combination of different conditions can occur simultaneously. Only condition 1 and 2 cannot be activated at the same time. For them, one bit indicates that the threshold interrupt is on or off, a second bit indicates if it is for proximity or ambient light.

When an interrupt is generated, the information about the condition that has generated the interrupt will be stored and is available for the user in an interrupt status register which can be read out via I²C. Each condition that can generate an interrupt has a dedicated result flag. This allows independent handling of the different conditions. For example, if the interrupt is generated by the upper threshold condition and a measurement ready condition, both flags are set.

To clear the interrupt line, the user has to clear the enabled interrupt flag in the interrupt status register, Register 14. Resetting the interrupt status register is done with an I²C write command. One interrupt bit can be cleared without affecting another. If there was a second interrupt source, it would have to be cleared separately. With a write command where all four interrupt bits are set to “1” all these bits and the interrupt line is cleared or reset.



Designing the VCNL4020 Into an Application

REGISTER FUNCTIONS

Register #0 Command Register

Register address = 80h

Register #0 is for starting ambient light or proximity measurements. The register contains 2 flag bits for data indication.

TABLE 1 - COMMAND REGISTER #0							
BIT 7	BIT 6	BIT 5	BIT 4	BIT 3	BIT 2	BIT 1	BIT 0
config_lock	als_data_rdy	prox_data_rdy	als_od	prox_od	als_en	prox_en	selftimed_en
DESCRIPTION							
Config_lock		Read only bit. Value = 1					
als_data_rdy		Read only bit. Value = 1 when ambient light measurement data is available in the result registers. This bit will be reset when one of the corresponding result registers (reg #5, reg #6) is read.					
prox_data_rdy		Read only bit. Value = 1 when proximity measurement data is available in the result registers. This bit will be reset when one of the corresponding result registers (reg #7, reg #8) is read.					
als_od		R/W bit. Starts a single on-demand measurement for ambient light. If averaging is enabled, starts a sequence of readings and stores the averaged result. Result is available at the end of conversion for reading in the registers #5 (HB) and #6 (LB).					
prox_od		R/W bit. Starts a single on-demand measurement for proximity. Result is available at the end of conversion for reading in the registers #7 (HB) and #8 (LB).					
als_en		R/W bit. Enables periodic als measurement					
prox_en		R/W bit. Enables periodic proximity measurement					
selftimed_en		R/W bit. Enables state machine and LP oscillator for selftimed measurements; no measurement is performed until the corresponding bit is set.					

When single on demand measurements are made, bit 3 and bit 4 are set with the same write command, ambient light and proximity measurements will both be made at the same time. For periodic measurements, the selftimed_en bit must be set first, then the als_en and/or prox_en bit(s) can be set.

On-demand measurement modes are disabled when the selftimed_en bit is set.

To avoid synchronization problems and undefined states between the clock domains, changes to the proximity or ambient light measurement rates in register #2 and register #4 respectively can be made only when there are no selftimed measurements being made, b0 (selftimed_en bit) = 0.

Register #1 Product ID Revision Register

Register address = 81h. This register contains information about product ID and product revision.

Register data value of current revision = 21h.

TABLE 2 - PRODUCT ID REVISION REGISTER #1							
BIT 7	BIT 6	BIT 5	BIT 4	BIT 3	BIT 2	BIT 1	BIT 0
PRODUCT ID				REVISION ID			
DESCRIPTION							
Product ID		Read only bits. Value = 2					
Revision ID		Read only bits. Value = 1					



Designing the VCNL4020 Into an Application

Register #2 Rate of Proximity Measurement

Register address = 82h. This register contains the rate of proximity measurements to be carried out within 1 second.

TABLE 3 - PROXIMITY RATE REGISTER #2							
BIT 7	BIT 6	BIT 5	BIT 4	BIT 3	BIT 2	BIT 1	BIT 0
n/a					Rate of proximity measurement (no. of measurements per second)		
DESCRIPTION							
Proximity rate		R/W bits. 000 - 1.95 measurements/s (default setting) 001 - 3.90625 measurements/s 010 - 7.8125 measurements/s 011 - 16.625 measurements/s 100 - 31.25 measurements/s 101 - 62.5 measurements/s 110 - 125 measurements/s 111 - 250 measurements/s					

Again, if selftimed measurements are being made, any new measurement rate written to this register will not be made until selftimed_en measurement is stopped.

Register #3 LED Current Setting for Proximity Mode

Register address = 83h. This register is to set the current of the infrared emitter for proximity measurements. The value is adjustable from 0 mA to 200 mA in 10 mA steps. This register also contains information about the used device fuse program ID.

TABLE 4 - IR LED CURRENT REGISTER #3							
BIT 7	BIT 6	BIT 5	BIT 4	BIT 3	BIT 2	BIT 1	BIT 0
Fuse prog ID					Infrared emitter current		
DESCRIPTION							
Fuse prog ID		Read only bits. Information about fuse program revision used for initial setup/calibration of the device.					
Infrared emitter current value		R/W bits. IR LED current = Value (dec.) x 10 mA. Valid Range = 0 - 20d (00 - 14 h) 0 = 0 mA 1 = 10 mA 2 = 20 mA (default setting) . . 20 = 200 mA, LED Current is limited to 200 mA. If higher values than 20d (14h) are written, the current will be set to 200 mA.					

APPLICATION NOTE



Designing the VCNL4020 Into an Application

Register #4 Ambient Light Parameter Register

Register address = 84h.

TABLE 5 - AMBIENT LIGHT PARAMETER REGISTER #4							
BIT 7	BIT 6	BIT 5	BIT 4	BIT 3	BIT 2	BIT 1	BIT 0
Continuous conversion mode	als_rate			Auto offset compensation	Average function (number of measurements per run)		
DESCRIPTION							
Continuous conversion mode	R/W bit. Continuous conversion mode. Enable = 1 ; Disable = 0 (default) This function can be used for performing faster ambient light measurements. Please refer to the application information chapter 3.3 for details about this function.						
Ambient light measurement rate	R/W bits. Ambient light measurement rate 000 - 1 samples/s 001 - 2 samples/s (default setting) 010 - 3 samples/s 011 - 4 samples/s 100 - 5 samples/s 101 - 6 samples/s 110 - 8 samples/s 111 - 10 samples/s						
Auto offset compensation	R/W bit. Automatic offset compensation. Enable = 1 (default) ; Disable = 0 In order to compensate for temperature related drift of the ambient light values, there is a built-in, automatic offset compensation function. With auto offset compensation enabled, the offset value is measured before each ambient light measurement and subtracted automatically from the actual reading.						
Averaging function	R/W bits. Averaging function. Bit value sets the number of single conversions done during one measurement cycle. Result is the average value of all conversions. Number of conversions = 2 decimal_value Bit 2, bit1, bit 0 000 - 1 conversion 001 - 2 conversions 010 - 4 conversions 011 - 8 conversions 100 - 16 conversions 101 - 32 conversions (default setting) 110 - 64 conversions 111 - 128 conversions						

Again, if selftimed measurements are being made, any new measurement rate written to this register will not be made until selftimed_en measurement is stopped.



Designing the VCNL4020 Into an Application

Register #5 and #6 Ambient Light Result Register

Register address = 85h and 86h. These registers are the result registers for ambient light measurement readings. The result is a 16 bit value. The high byte is stored in register #5 and the low byte in register #6.

TABLE 6 - AMBIENT LIGHT RESULT REGISTER #5							
BIT 7	BIT 6	BIT 5	BIT 4	BIT 3	BIT 2	BIT 1	BIT 0
DESCRIPTION							
Read only bits. High byte (15:8) of ambient light measurement result							

TABLE 7 - AMBIENT LIGHT RESULT REGISTER #6							
BIT 7	BIT 6	BIT 5	BIT 4	BIT 3	BIT 2	BIT 1	BIT 0
DESCRIPTION							
Read only bits. Low byte (7:0) of ambient light measurement result							

Register #7 and #8 Proximity Measurement Result Register

Register address = 87h and 88h. These registers are the result registers for proximity measurement readings. The result is a 16 bit value. The high byte is stored in register #7 and the low byte in register #8.

TABLE 8 - PROXIMITY RESULT REGISTER #7							
BIT 7	BIT 6	BIT 5	BIT 4	BIT 3	BIT 2	BIT 1	BIT 0
DESCRIPTION							
Read only bits. High byte (15:8) of proximity measurement result							

TABLE 9 - PROXIMITY RESULT REGISTER #8							
BIT 7	BIT 6	BIT 5	BIT 4	BIT 3	BIT 2	BIT 1	BIT 0
DESCRIPTION							
Read only bits. Low byte (7:0) of proximity measurement result							

Register #9 Interrupt Control Register

Register address = 89h.

TABLE 10 - INTERRUPT CONTROL REGISTER #9							
BIT 7	BIT 6	BIT 5	BIT 4	BIT 3	BIT 2	BIT 1	BIT 0
int_count_exceed			N/A	int_prox_ready_en	int_als_ready_en	int_thres_en	int_thres_sel
DESCRIPTION							
int_count_exceed			R/W bits. These bits contain the number of consecutive measurements needed above/below the threshold 000 - 1 count (default setting) 001 - 2 counts 010 - 4 counts 011 - 8 counts 100 - 16 counts 101 - 32 counts 110 - 64 counts 111 - 128 counts				
int_prox_ready_en			R/W bit. Enables interrupt generation when proximity data is ready				
int_als_ready_en			R/W bit. Enables interrupt generation when ambient data is ready				
int_thres_en			R/W bit. Enables interrupt generation when high or low threshold is exceeded				
int_thres_sel			R/W bit. If 0: thresholds are applied to proximity measurements If 1: thresholds are applied to ambient light measurements				



Designing the VCNL4020 Into an Application

Register #10 and #11 Low Threshold

Register address = 8Ah and 8Bh. These registers contain the low threshold value. The value is a 16 bit word. The high byte is stored in register #10 and the low byte in register #11

TABLE 11 - LOW THRESHOLD REGISTER #10							
BIT 7	BIT 6	BIT 5	BIT 4	BIT 3	BIT 2	BIT 1	BIT 0
DESCRIPTION							
R/W bits. High byte (15:8) of low threshold value							

TABLE 12 - LOW THRESHOLD REGISTER #11							
BIT 7	BIT 6	BIT 5	BIT 4	BIT 3	BIT 2	BIT 1	BIT 0
DESCRIPTION							
R/W bits. Low byte (7:0) of low threshold value							

Register #12 and #13 High Threshold

Register address = 8Ch and 8Dh. These registers contain the high threshold value. The value is a 16 bit word. The high byte is stored in register #12 and the low byte in register #13

TABLE 13 - HIGH THRESHOLD REGISTER #12							
BIT 7	BIT 6	BIT 5	BIT 4	BIT 3	BIT 2	BIT 1	BIT 0
DESCRIPTION							
R/W bits. High byte (15:8) of high threshold value							

TABLE 14 - HIGH THRESHOLD REGISTER #13							
BIT 7	BIT 6	BIT 5	BIT 4	BIT 3	BIT 2	BIT 1	BIT 0
DESCRIPTION							
R/W bits. Low byte (7:0) of high threshold value							

Register #14 Interrupt Status Register

Register address = 8Eh. This register contains information about the interrupt status for either proximity or ambient light measurement and indicates a threshold was exceeded.

TABLE 15 - INTERRUPT STATUS REGISTER #14							
BIT 7	BIT 6	BIT 5	BIT 4	BIT 3	BIT 2	BIT 1	BIT 0
N/A				int_prox_ready	int_als_ready	int_th_low	int_th_high
DESCRIPTION							
int_prox_ready				R/W bit. Indicates a generated interrupt for proximity			
int_als_ready				R/W bit. Indicates a generated interrupt for als			
int_th_low				R/W bit. Indicates a low threshold was exceed			
int_th_high				R/W bit. Indicates a high threshold was exceed			

Once an interrupt is generated, the corresponding status bit goes to 1 and stays there until it is cleared by writing a 1 in the corresponding bit. For example, when an upper threshold is exceeded, an interrupt is generated. The int_th_hi status bit goes to 1. It will stay at 1 until it is cleared by overwriting a 1 in the int_th_hi bit. The interrupt pad will be pulled down as long as one of the status bits is 1.

APPLICATION NOTE



Designing the VCNL4020 Into an Application

Register #15 Proximity Modulator Timing Adjustment

Register address = 8Fh.

TABLE 16 - MODULATOR TIMING ADJUSTMENT REGISTER #15							
BIT 7	BIT 6	BIT 5	BIT 4	BIT 3	BIT 2	BIT 1	BIT 0
MODULATION DELAY TIME			PROXIMITY FREQUENCY		MODULATION DEAD TIME		
DESCRIPTION							
Modulation delay time			R/W bits. Sets a delay time between infrared emitter signal and infrared input signal evaluation. This function is to compensate for delays between the emitter and photo diode when external emitters are used and may also be used with the faster proximity frequencies. It is used to optimize the measurement signal level.				
Proximity frequency			R/W Bits. Sets the proximity infrared signal frequency The proximity measurement uses a square signal as measurement signal. Four different frequencies are possible: 00 = 390.625 kHz (Default Setting) 01 = 781.25 kHz 10 = 1.5625 MHz (not recommended) 11 = 3.125 MHz (not recommended)				
Modulation dead time			R/W bits. Sets a time period when the reflected infrared signal is not read. This compensates for the rise time slope of the emitter and resulting slope of the reflected signal. Values of 0 to 7 are allowed. The default value is 1. This function reduces possible disturbance effects but also can reduce signal levels.				

User access for this register was maintained for applications using external infrared emitters. For applications using only the internal emitter, the default register values are already optimized for proximity operation: delay time = 0, proximity frequency = 390 kHz, and dead time = 1.

Modulation Delay Time

The proximity function works with a modulated signal. The proximity signal demodulator is frequency and phase sensitive and references to the transmitted signal. In case of external infrared emitters with additional driver stages, there might be signal delays that could cause signal loss. By adjusting the “delay time” setting, this additional delay can be compensated. The delay time can be set to values between 0 and 7. Using external infrared emitters the optimum setting is determined by trying different settings. The setting with highest readings for proximity at a certain reflection condition should be selected. Since most applications will use the internal emitter, the default value is 0.

Proximity Frequency

This parameter was used during the development of the VCNL4020. The default setting of f = 390 kHz is the optimum setting.

Modulation Dead Time

Due to the emitter rise and fall times, the modulation signal is not a perfect square wave. Instead a slight slope occurs at the start and end of the signal. The modulation dead time defines a time window or range where the slopes from the received modulated signal are blanked out. This function eliminates effects from slow slopes, glitches and other noise disturbances on the received signal. If the modulation dead time is set too long, a portion of the reflected signal will be lost in addition to the rise time slope. The modulation dead time can be set to values between 0 and 7. The default setting is 1. This setting is sufficient to suppress noise transients. It is NOT recommended to use the value “0” as a “dead time” setting. When using an external driver and emitters, it might be necessary to adjust this parameter. An external driver might cause slow slopes, unstable readings or higher noise. Such effects could be reduced by adjusting this parameter.

APPLICATION NOTE

Designing the VCNL4020 Into an Application

APPLICATION EXAMPLE

The following example will demonstrate the ease of using the VCNL4020 sensor. Customers are strongly encouraged to purchase a SensorXplorer and VCNL4020 sensor board from any listed distributor:

www.vishay.com/optoelectronics/SensorXplorer.

Offset

During development, the application-specific offset counts for the sensor were determined. As previously mentioned, the offset count is affected by the components surrounding the VCNL4020, the window or cover being used, the distance from the sensor to the cover and emitter intensity which is controlled by the forward current. In the following example, with a cover over the sensor and setting the emitter current to 100 mA, the offset counts are 5400 counts, Fig. 20. Offset counts vary by application and can be anywhere from 5000 counts to 20 000 counts. It is important to note that the offset count may change slightly over time due to, for example, the window becoming scratched or dirty, or being exposed to high temperature changes. If possible, the offset value should occasionally be checked and, if necessary, modified.

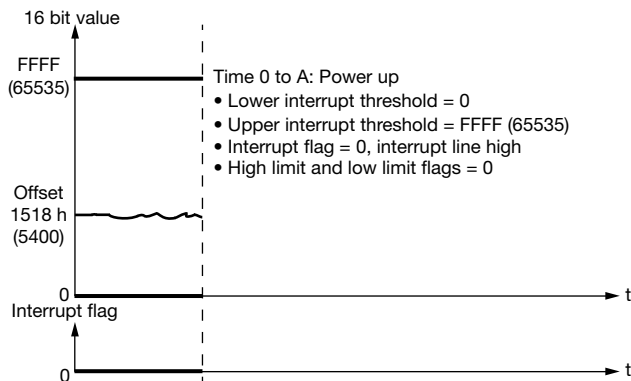

Fig. 20

Power Up

As mentioned, there are three variables that need to be set in the register when the sensor is powered up: the emitter current, the number of occurrences that must exceed a threshold to generate an interrupt and the number of proximity measurements per second. For the application, the sensor should detect an object at 5 cm distance. Development testing determined that a current of 100 mA produces adequate counts for detection. The proximity measurement rate is set to 7.8125 measurements per second and the number of occurrences to trigger an interrupt is set to 4. Based on development testing, with a hand approximately 5 cm above the window cover, the resulting count is 5500. This will be used as the upper

threshold.

For smart phone applications it would be typical to initially set only an upper threshold. However, in other sensing applications, a lower threshold may also be set. This creates an operating band where any change in the objects position would trigger a threshold as shown in Fig. 21.

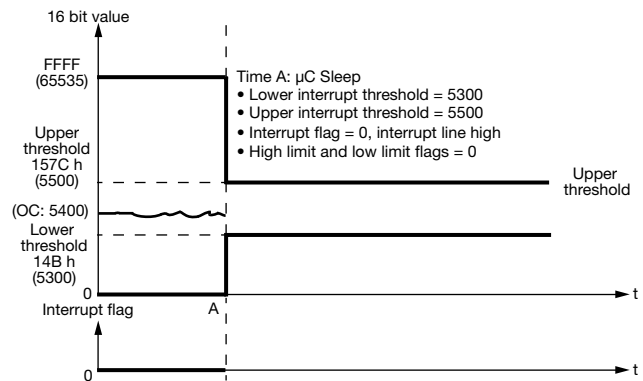

Fig. 21

By setting the number of occurrences before generating an interrupt to 4, a single proximity value above or below the thresholds will have no effect as shown in Figure 22.

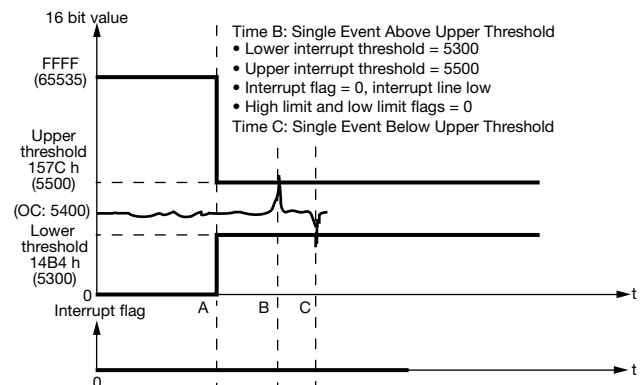

Fig. 22

Once an object is detected, the sensor can be switched to continuous polling or the thresholds can be reprogrammed. A smartphone application will use a proximity sensor to detect when the phone is brought to the user's ear and disable the touch screen and turn off the backlight. For other applications, the action taken when an object is detected is very application specific. For example, soap may be dispensed, paper towels may be unrolled, a blower turns on, or a lid is opened.

Designing the VCNL4020 Into an Application

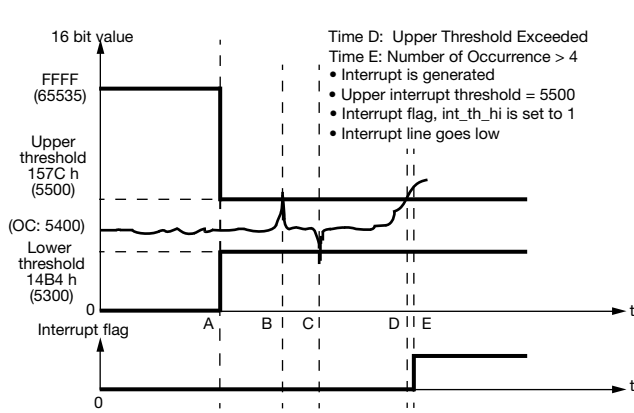

Fig. 23

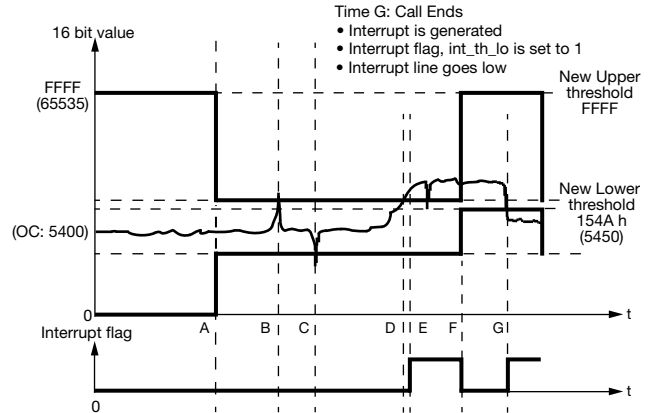

Fig. 25

In smart phone applications, the thresholds will be reprogrammed and the sensor will wait for another interrupt signal. In this case, the upper threshold should be set to a maximum value since the phone is already next to the user's ear and a lower threshold set so when the phone call is complete and the phone brought away from the ear, the backlight and touch screen will be turned back on.

The upper threshold needs to be set as high as possible since an interrupt has already been generated; set to FFFF (65535). The lower threshold is set to 5450 counts; a value that is higher than the offset but low enough to indicate the removal of the phone from the users ear.

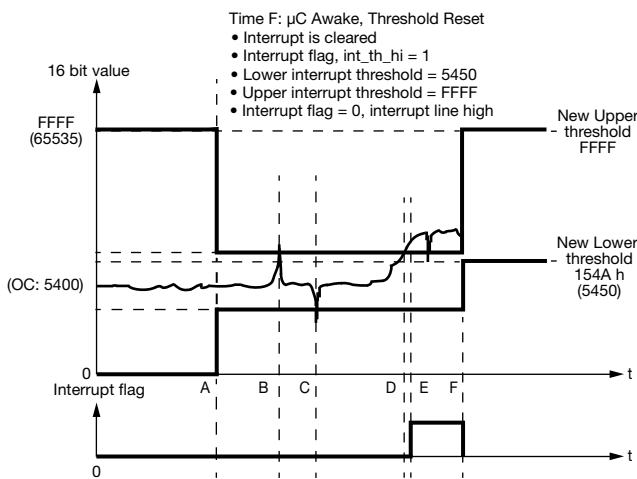

Fig. 24

When the object is removed, the sensor counts will return to 5400 counts and the lower threshold will generate an interrupt, **int_th_low = 1**.



Designing the VCNL4020 Into an Application

EXAMPLE REGISTER SETTINGS

When the sensor is powered-up the first time, the default register settings are made for the application.

ACTION	REGISTER SETTING
Set infrared emitter current to 100 mA	REGISTER #3 [83h]: 26, 83, 0A
Set proximity measurement rate to 7.8125 measurements/s	REGISTER # 2 [82h]: 26, 82, 02
Set ambient light sensor mode to normal, the measurement rate to 2 measurements/s and the averaging to 32 conversions	REGISTER #4 [84h]: 26, 84, 1D
Set number of consecutive measurements that must occur to initiate an interrupt to 4: Generate an interrupt when the threshold is exceeded Thresholds are for proximity measurements	Register # 9 [89h]: 26, 89, 42 42 h: int_count_exceed = 4 int_thres_en = 1 int_thres_sel = 0

DEFAULT VALUE SET-UP ONLY AS HEXADECIMAL CODE IS:	
26, 83, 0A	write: IRED current = 10 (= 100 mA)
26, 82, 02	write: Prox rate = 02 (= 8 measure/s)
26, 84, 1D	write: ALS mode = 1D (= measure/s, auto-offset = on, averaging = 5)
26, 89, 42	write: Int cntr reg = 42 (= int_count_exceed = 4, int_thres_en = 1, int_thres_sel = 0)

Set an upper threshold for detecting an object and do not set a lower threshold.

ACTION	REGISTER SETTING
Set lower threshold value to 0 counts	Register #10 (8Ah): 26, 8A, 00 Register #11 (8Bh): 26, 8B, 00
Set upper threshold value to 5860 counts - 16E4 (hex)	Register #12 (8Ch): 26, 8C, 16 Register #13 (8Dh): 26, 8D, E4
Start periodic proximity measurements	Register #0 (80h): 26, 80, 03
Read interrupt status register	Register #14 (8Eh): 26, 8E, 27, xx

THIS PROXIMITY SET-UP SHOWN ONLY AS HEXADECIMAL CODE IS:	
26, 8A, 00	write: L_TH_HB = 00
26, 8B, 00	write: L_TH_LB = 00
26, 8C, 16	write: H_TH_HB = 16
26, 8D, E4	write: H_TH_LB = E4
26, 80, 03	write: 3: prox_en = 1, selftimed_en = 1
WAIT	at least 400 μs
26, 8E, 27, xx	read: xxxxxx1, indicates int_th_hi = 1

Assuming an object was detected, the interrupt was cleared and the software reprograms the thresholds to be able to respond when the object is no longer present. The upper threshold is set to FFFF counts while the lower threshold is set to 5810 counts.

ACTION	REGISTER SETTING
Set lower threshold to 5810 counts - 16B2 (hex)	Register #10 (8Ah): 26, 8A, 16 Register #11 (8Bh): 26, 8B, B2
Set upper threshold to maximum counts - FFFF (hex)	Register #12 (8Ch): 26, 8C, FF Register #13 (8Dh): 26, 8D, FF
Start periodic proximity measurements	Register #0 (80h): 26, 80, 03
Read interrupt status register	Register #14 (8Eh): 26, 8E, 27, xx



Designing the VCNL4020 Into an Application

THIS PROXIMITY SET-UP SHOWN ONLY AS HEXADECIMAL CODE IS:

26, 8A, 16	write: L_TH_HB = 16
26, 8B, B2	write: L_TH_LB = B2
26, 8C, FF	write: H_TH_HB = FF
26, 8D, FF	write: H_TH_LB = FF
26, 80, 03	write: 3: prox_en = 1, selftimed_en = 1
WAIT	at least 400 µs
26, 8E, 27, xx	read: xxxxxx1x, indicates int_th_lo = 1

PROGRAMM FLOW CHART

Initial setup for proximity sensor. Note that default values do not need to be programmed.

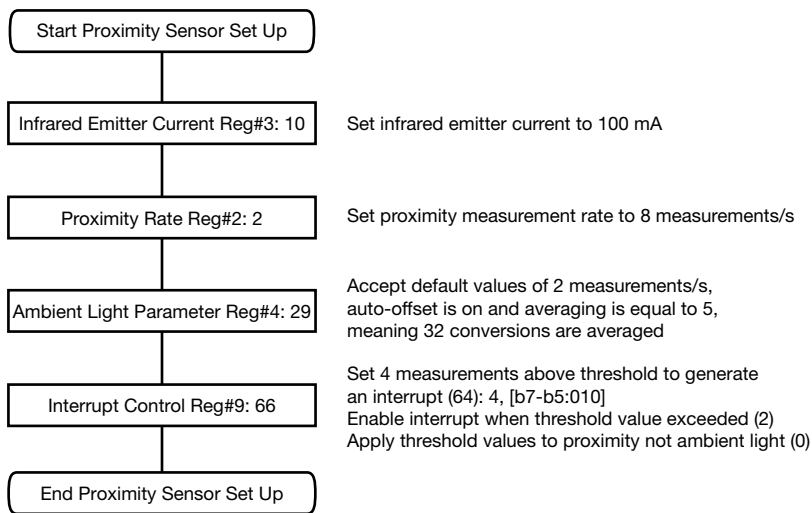



Designing the VCNL4020 Into an Application

Defining the Upper Threshold

The upper threshold value is set so that an interrupt is generated when an object comes close enough to the sensor to create a defined increase in counts. In this example, the offset counts are 5760 and the upper threshold is set 100 counts above the offset.

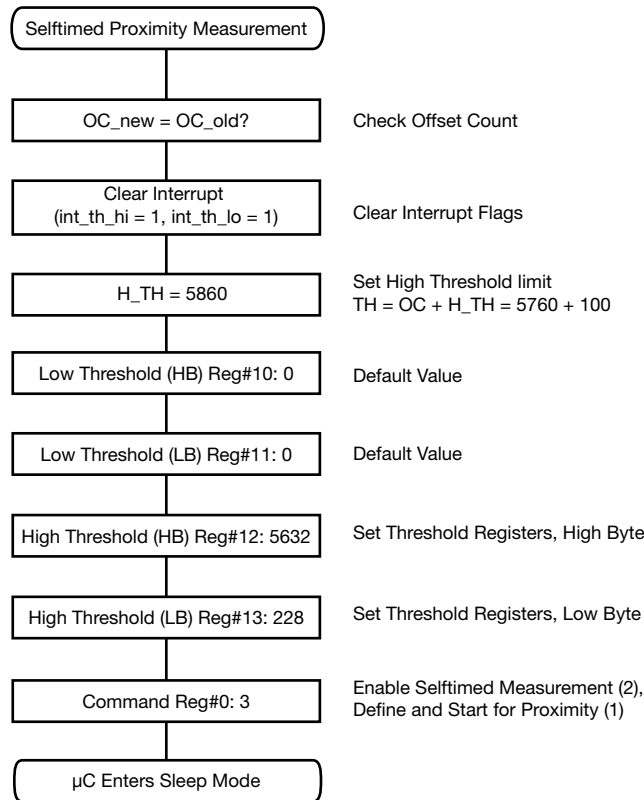

When an object does come close enough to the sensor to generate 100 counts and 4 consecutive measurements occur at or above this level, the interrupt line will go LOW and the interrupt can be read by the microcontroller in register 14 where int_th_hi will equal 1.



Designing the VCNL4020 Into an Application

Redefine Thresholds

Once the counts have surpassed the initial high threshold, a low threshold needs to be set to generate an interrupt when the object is removed. The upper threshold should no longer lead to an interrupt and is therefore set to maximum value. The offset counts within this example are chosen for 5760 and then upper threshold set to 100 counts above this, so to 5860. The lower threshold is just defined for half of this 100 delta counts, so to 50. With this the lower threshold is set to $5760 + 50 = 5810$.

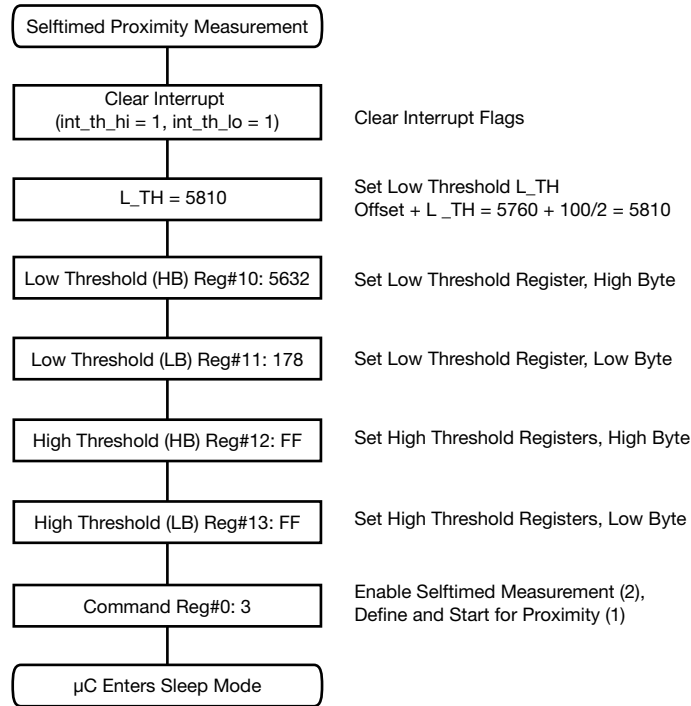

When the object is removed and 4 consecutive measurements occur at or below the lower threshold, the interrupt line will go LOW and the interrupt can be read by the microcontroller in register 14 where int_th_lo will equal 1.

Designing the VCNL4020 Into an Application

Complete Flow Chart

