

# High Current Density Surface Mount Schottky Rectifiers

## eSMP® Series



SMP (DO-220AA)

Cathode Anode

### DESIGN SUPPORT TOOLS

[click logo to get started](#)



PRIMARY CHARACTERISTICS	
$I_{F(AV)}$	3.0 A
$V_{RRM}$	40 V
$I_{FSM}$	50 A
$E_{AS}$	11.25 mJ
$V_F$	0.50 V
$T_J$ max.	150 °C
Package	SMP (DO-220AA)
Circuit configuration	Single

### FEATURES

- Very low profile - typical height of 1.0 mm
- Ideal for automated placement
- Low forward voltage drop, low power losses
- High efficiency
- Low thermal resistance
- Meets MSL level 1, per J-STD-020, LF maximum peak of 260 °C
- AEC-Q101 qualified
- Material categorization: for definitions of compliance please see [www.vishay.com/doc?99912](http://www.vishay.com/doc?99912)

AUTOMOTIVE  
GRADE  
Available



RoHS  
COMPLIANT  
HALOGEN  
FREE

### TYPICAL APPLICATIONS

For use in low voltage high frequency inverters, freewheeling, DC/DC converters, and polarity protection applications.

### MECHANICAL DATA

**Case:** SMP (DO-220AA)

Molding compound meets UL 94 V-0 flammability rating  
Base P/N-M3 - halogen-free, RoHS-compliant, and commercial grade

Base P/NHM3 - halogen-free, RoHS-compliant, and automotive grade

**Terminals:** matte tin plated leads, solderable per J-STD-002 and JESD 22-B102

M3 suffix meets JESD 201 class 1A whisker test, HM3 suffix meets JESD 201 class 2 whisker test

**Polarity:** color band denotes the cathode end

MAXIMUM RATINGS ( $T_A = 25\text{ °C}$ unless otherwise noted)			
PARAMETER	SYMBOL	SS3P4	UNIT
Device marking code		34	
Maximum repetitive peak reverse voltage	$V_{RRM}$	40	V
Maximum average forward rectified current (fig. 1)	$I_{F(AV)}$	3.0	A
Peak forward surge current 8.3 ms single half sine-wave superimposed on rated load	$I_{FSM}$	50	A
Non-repetitive avalanche energy at $T_J = 25\text{ °C}$ , $I_{AS} = 1.5\text{ A}$ , $L = 10\text{ mH}$	$E_{AS}$	11.25	mJ
Voltage rate of change (rated $V_R$ )	dV/dt	10 000	V/ $\mu$ s
Operating junction and storage temperature range	$T_J, T_{STG}$	-55 to +150	°C

<b>ELECTRICAL CHARACTERISTICS</b> ( $T_A = 25\text{ }^\circ\text{C}$ unless otherwise noted)						
PARAMETER	TEST CONDITIONS		SYMBOL	TYP.	MAX.	UNIT
Maximum instantaneous forward voltage	$I_F = 3\text{ A}$	$T_J = 25\text{ }^\circ\text{C}$	$V_F^{(1)}$	0.55	0.60	V
		$T_J = 125\text{ }^\circ\text{C}$		0.50	0.55	
Maximum reverse current at rated $V_R$		$T_J = 25\text{ }^\circ\text{C}$	$I_R^{(2)}$	-	150	$\mu\text{A}$
		$T_J = 125\text{ }^\circ\text{C}$		7.5	15	mA
Typical junction capacitance	4.0 V, 1 MHz		$C_J$	130		pF

**Notes**

- (1) Pulse test: 300  $\mu\text{s}$  pulse width, 1 % duty cycle  
 (2) Pulse test: Pulse width  $\leq 40\text{ ms}$

<b>THERMAL CHARACTERISTICS</b> ( $T_A = 25\text{ }^\circ\text{C}$ unless otherwise specified)			
PARAMETER	SYMBOL	SS3P4	UNIT
Typical thermal resistance <sup>(1)</sup>	$R_{\theta JA}^{(1)}$	85	$^\circ\text{C/W}$
	$R_{\theta JL}^{(1)}$	15	
	$R_{\theta JC}^{(1)}$	20	

**Note**

- (1) Thermal resistance from junction to ambient and junction to lead mounted on PCB with 15 mm x 15 mm copper pad areas.  $R_{\theta JL}$  is measured at the terminal of cathode band.  $R_{\theta JC}$  is measured at the top center of the body

<b>ORDERING INFORMATION</b> (Example)				
PREFERRED P/N	UNIT WEIGHT (g)	PREFERRED PACKAGE CODE	BASE QUANTITY	DELIVERY MODE
SS3P4-M3/84A	0.024	84A	3000	7" diameter plastic tape and reel
SS3P4-M3/85A	0.024	85A	10 000	13" diameter plastic tape and reel
SS3P4HM3/84A <sup>(1)</sup>	0.024	84A	3000	7" diameter plastic tape and reel
SS3P4HM3/85A <sup>(1)</sup>	0.024	85A	10 000	13" diameter plastic tape and reel

**Note**

- (1) Automotive grade

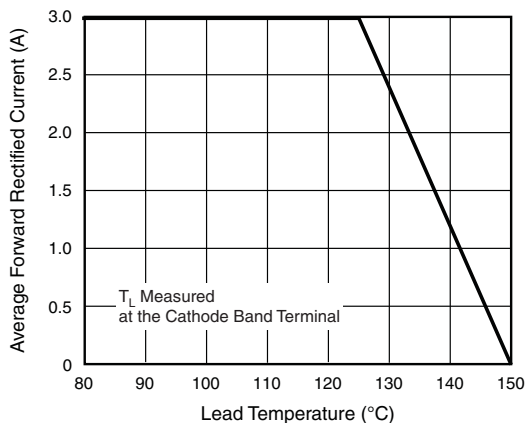
**RATINGS AND CHARACTERISTICS CURVES** ( $T_A = 25\text{ }^\circ\text{C}$  unless otherwise specified)


Fig. 1 - Forward Current Derating Curve

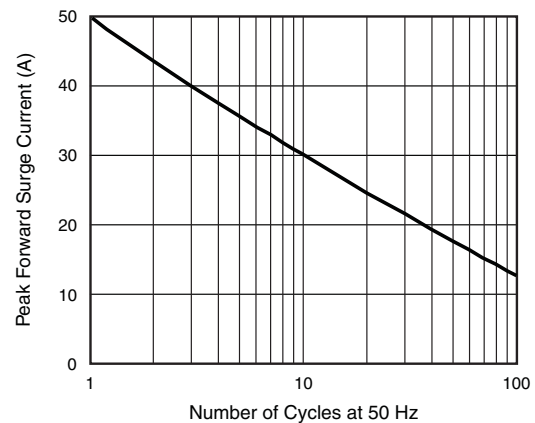


Fig. 2 - Maximum Non-Repetitive Peak Forward Surge Current

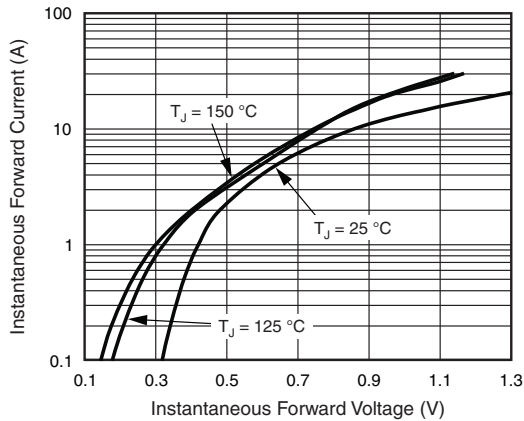


Fig. 3 - Typical Instantaneous Forward Characteristics

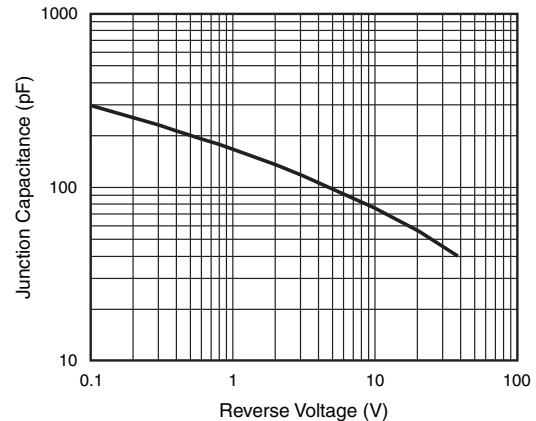


Fig. 5 - Typical Junction Capacitance

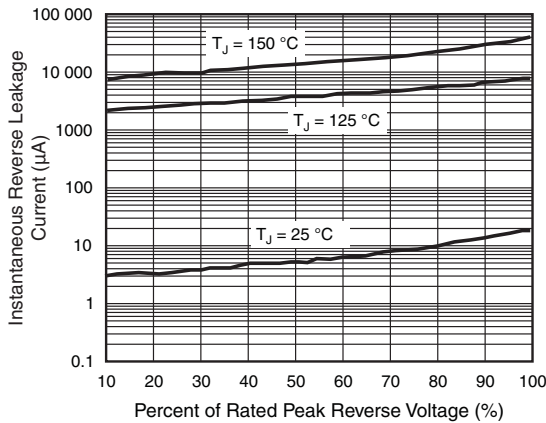


Fig. 4 - Typical Reverse Leakage Characteristics

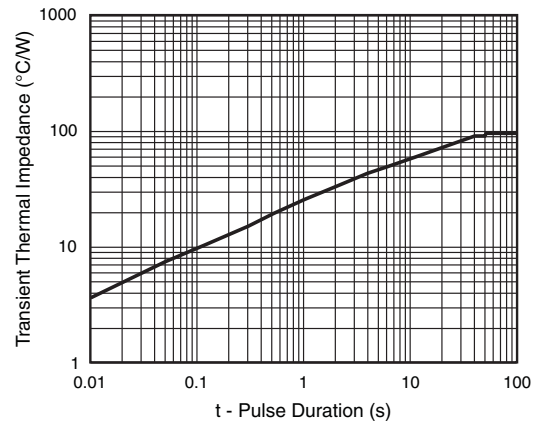
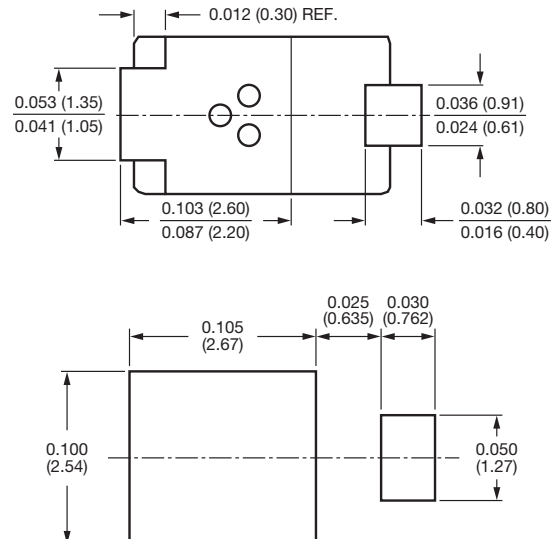
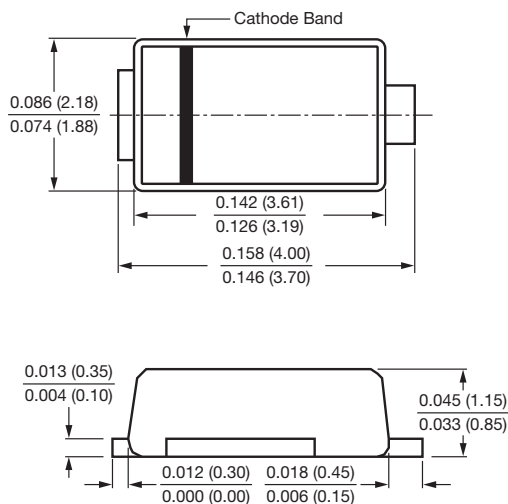


Fig. 6 - Typical Transient Thermal Impedance

**PACKAGE OUTLINE DIMENSIONS** in inches (millimeters)

**SMP (DO-220AA)**





## Disclaimer

ALL PRODUCT, PRODUCT SPECIFICATIONS AND DATA ARE SUBJECT TO CHANGE WITHOUT NOTICE TO IMPROVE RELIABILITY, FUNCTION OR DESIGN OR OTHERWISE.

Vishay Intertechnology, Inc., its affiliates, agents, and employees, and all persons acting on its or their behalf (collectively, "Vishay"), disclaim any and all liability for any errors, inaccuracies or incompleteness contained in any datasheet or in any other disclosure relating to any product.

Vishay makes no warranty, representation or guarantee regarding the suitability of the products for any particular purpose or the continuing production of any product. To the maximum extent permitted by applicable law, Vishay disclaims (i) any and all liability arising out of the application or use of any product, (ii) any and all liability, including without limitation special, consequential or incidental damages, and (iii) any and all implied warranties, including warranties of fitness for particular purpose, non-infringement and merchantability.

Statements regarding the suitability of products for certain types of applications are based on Vishay's knowledge of typical requirements that are often placed on Vishay products in generic applications. Such statements are not binding statements about the suitability of products for a particular application. It is the customer's responsibility to validate that a particular product with the properties described in the product specification is suitable for use in a particular application. Parameters provided in datasheets and / or specifications may vary in different applications and performance may vary over time. All operating parameters, including typical parameters, must be validated for each customer application by the customer's technical experts. Product specifications do not expand or otherwise modify Vishay's terms and conditions of purchase, including but not limited to the warranty expressed therein.

Except as expressly indicated in writing, Vishay products are not designed for use in medical, life-saving, or life-sustaining applications or for any other application in which the failure of the Vishay product could result in personal injury or death. Customers using or selling Vishay products not expressly indicated for use in such applications do so at their own risk. Please contact authorized Vishay personnel to obtain written terms and conditions regarding products designed for such applications.

No license, express or implied, by estoppel or otherwise, to any intellectual property rights is granted by this document or by any conduct of Vishay. Product names and markings noted herein may be trademarks of their respective owners.