

Primary MTP IGBT Power Module

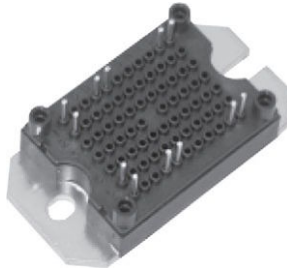

MTP

FEATURES

- Buck PFC stage with warp 2 IGBT and FRED Pt[®] hyperfast diode
- Integrated thermistor
- Isolated baseplate
- UL approved file E78996
- Very low stray inductance design for high speed operation
- Designed and qualified for industrial level
- Material categorization: for definitions of compliance please see www.vishay.com/doc?99912

RoHS
COMPLIANT

BENEFITS

- Lower conduction losses and switching losses
- Higher switching frequency up to 150 kHz
- Optimized for welding, UPS, and SMPS applications
- PCB solderable terminals
- Direct mounting to heatsink

PRIMARY CHARACTERISTICS	
FRED Pt[®] AP DIODE, T_J = 150 °C	
V _{RRM}	600 V
I _{F(DC)} at 80 °C	11 A
V _F at 25 °C at 60 A	2.08 V
IGBT, T_J = 150 °C	
V _{CES}	600 V
V _{CE(on)} at 25 °C at 60 A	1.98 V
I _C at 80°C	83 A
FRED Pt[®] CHOPPER DIODE, T_J = 150 °C	
V _R	600 V
I _{F(DC)} at 80 °C	17 A
V _F at 25 °C at 60 A	2.06 V
Speed	30 kHz to 150 kHz
Package	MTP
Circuit configuration	Dual forward

ABSOLUTE MAXIMUM RATINGS					
	PARAMETER	SYMBOL	TEST CONDITIONS	MAX.	UNITS
FRED Pt antiparallel diode	Repetitive peak reverse voltage	V _{RRM}		600	V
	Maximum continuous forward current T _J = 150 °C maximum	I _{F(DC)}	T _C = 25 °C	17	A
			T _C = 80 °C	11	
Maximum power dissipation	P _D	T _C = 25 °C	25	W	
IGBT	Collector to emitter voltage	V _{CES}	T _J = 25 °C	600	V
	Gate to emitter voltage	V _{GE}	I _{GES} max. ± 250 ns	± 20	V
	Maximum continuous collector current at V _{GE} = 15 V, T _J = 150 °C maximum	I _C	T _C = 25 °C	121	A
			T _C = 80 °C	83	
	Clamped inductive load current	I _{LM}		300	
Maximum power dissipation	P _D	T _C = 25 °C	462	W	
FRED Pt chopper diode	Repetitive peak reverse voltage	V _{RRM}		600	V
	Maximum continuous forward current T _J = 150 °C maximum	I _F	T _C = 25 °C	26	A
			T _C = 80 °C	17	
Maximum power dissipation	P _D	T _C = 25 °C	56	W	
	Maximum operating junction temperature	T _J		150	°C
	Storage temperature range	T _{Stg}		-40 to +150	
	Isolation voltage	V _{ISOL}	V _{RMS} t = 1 s, T _J = 25 °C	3500	



ELECTRICAL SPECIFICATIONS ($T_J = 25\text{ }^\circ\text{C}$ unless otherwise noted)							
	PARAMETER	SYMBOL	TEST CONDITIONS	MIN.	TYP.	MAX.	UNITS
AP diode	Blocking voltage	BV_{RRM}	0.5 mA	600	-	-	V
	Forward voltage drop	V_{FM}	$I_F = 60\text{ A}$	-	2.08	2.43	V
$I_F = 60\text{ A}, T_J = 125\text{ }^\circ\text{C}$			-	2.05	2.3		
IGBT	Collector to emitter breakdown voltage	BV_{CES}	$V_{GE} = 0\text{ V}, I_C = 0.5\text{ mA}$	600	-	-	V
	Temperature coefficient of breakdown voltage	$\Delta V_{BR(CES)}/\Delta T_J$	$I_C = 0.5\text{ mA}$ (25 °C to 125 °C)	-	0.6	-	V/°C
	Collector to emitter voltage	$V_{CE(on)}$	$V_{GE} = 15\text{ V}, I_C = 60\text{ A}$	-	1.93	2.29	V
			$V_{GE} = 15\text{ V}, I_C = 60\text{ A}, T_J = 125\text{ }^\circ\text{C}$	-	2.36	2.80	
	Gate threshold voltage	$V_{GE(th)}$	$V_{CE} = V_{GE}, I_C = 500\text{ }\mu\text{A}$	2.9	-	6.0	V
	Collector to emitter leakage current	I_{CES}	$V_{GE} = 0\text{ V}, V_{CE} = 600\text{ V}$	-	-	100	μA
$V_{GE} = 0\text{ V}, V_{CE} = 600\text{ V}, T_J = 125\text{ }^\circ\text{C}$			-	-	2.0	mA	
Gate to emitter leakage	I_{GES}	$V_{GE} = \pm 20\text{ V}$	-	-	± 100	nA	
FRED Pt chopper diode	Forward voltage drop	V_{FM}	$I_F = 60\text{ A}$	-	2.06	2.53	V
			$I_F = 60\text{ A}, T_J = 125\text{ }^\circ\text{C}$	-	1.83	2.26	
	Blocking voltage	BV_{RM}	0.5 mA	600	-	-	
	Reverse leakage current	I_{RM}	$V_{RRM} = 600\text{ V}$	-	-	75	μA
$V_{RRM} = 600\text{ V}, T_J = 125\text{ }^\circ\text{C}$			-	-	0.5	mA	

RECOVERY PARAMETER							
AP diode	Peak reverse recovery current	I_{rr}	$I_F = 60\text{ A}$ $di/dt = 200\text{ A}/\mu\text{s}$ $V_R = 200\text{ V}$	-	67	11	A
	Reverse recovery time	t_{rr}		-	120	160	ns
	Reverse recovery charge	Q_{rr}		-	620	850	nC
FRED Pt chopper diode	Peak reverse recovery current	I_{rr}	$I_F = 60\text{ A}$ $di/dt = 200\text{ A}/\mu\text{s}$ $V_R = 200\text{ V}$	-	4.5	6.0	A
	Reverse recovery time	t_{rr}		-	67	85	ns
	Reverse recovery charge	Q_{rr}		-	130	250	nC
	Peak reverse recovery current	I_{rr}	$I_F = 60\text{ A}$ $di/dt = 200\text{ A}/\mu\text{s}$ $V_R = 200\text{ V}, T_J = 125\text{ }^\circ\text{C}$	-	9.5	12.0	A
	Reverse recovery time	t_{rr}		-	128	165	ns
	Reverse recovery charge	Q_{rr}		-	601	900	nC

SWITCHING CHARACTERISTICS ($T_J = 25\text{ }^\circ\text{C}$ unless otherwise noted)								
	PARAMETER	SYMBOL	TEST CONDITIONS	MIN.	TYP.	MAX.	UNITS	
PFC IGBT	Total gate charge	Q_g	$I_C = 60\text{ A}$ $V_{CC} = 480\text{ V}$ $V_{GE} = 15\text{ V}$	-	460	-	nC	
	Gate to source charge	Q_{gs}		-	160	-		
	Gate to drain (Miller) charge	Q_{gd}		-	70	-		
	Turn-on switching loss	E_{on}	$I_C = 100\text{ A}, V_{CC} = 360\text{ V}, V_{GE} = 15\text{ V}$ $R_g = 5\text{ }\Omega, L = 500\text{ }\mu\text{H}, T_J = 25\text{ }^\circ\text{C}$	-	0.2	-	mJ	
	Turn-off switching loss	E_{off}		-	0.96	-		
	Total switching loss	E_{tot}		-	1.16	-		
	Turn-on delay time	$t_{d(on)}$		-	240	-	ns	
	Rise time	t_r		-	47	-		
	Turn-off delay time	$t_{d(off)}$		-	240	-		
	Fall time	t_f	-	66	-			
	Turn-on switching loss	E_{on}	$I_C = 100\text{ A}, V_{CC} = 360\text{ V}, V_{GE} = 15\text{ V}$ $R_g = 5\text{ }\Omega, L = 500\text{ }\mu\text{H}, T_J = 125\text{ }^\circ\text{C}$	-	0.33	-		mJ
	Turn-off switching loss	E_{off}		-	1.45	-		
	Total switching loss	E_{tot}		-	1.78	-		
	Turn-on delay time	$t_{d(on)}$		-	246	-	ns	
	Rise time	t_r		-	50	-		
	Turn-off delay time	$t_{d(off)}$		-	246	-		
	Fall time	t_f		-	71	-		
	Input capacitance	C_{ies}		$V_{GE} = 0\text{ V}$	-	9500		-
Output capacitance	C_{oes}	$V_{CC} = 30\text{ V}$		-	780	-		
Reverse transfer capacitance	C_{res}	$f = 1\text{ MHz}$	-	120	-			



THERMISTOR ELECTRICAL CHARACTERISTICS ($T_J = 25\text{ }^\circ\text{C}$ unless otherwise noted)						
PARAMETER	SYMBOL	TEST CONDITIONS	MIN.	TYP.	MAX.	UNITS
Resistance	R	$T_J = 25\text{ }^\circ\text{C}$	-	30 000	-	Ω
B value	B	$T_J = 25\text{ }^\circ\text{C}/T_J = 85\text{ }^\circ\text{C}$	-	4000	-	K

THERMAL AND MECHANICAL SPECIFICATIONS						
	PARAMETER	SYMBOL	MIN.	TYP.	MAX.	UNITS
AP FRED Pt diode	Junction to case diode thermal resistance	R_{thJC}	-	-	4.9	$^\circ\text{C}/\text{W}$
IGBT	Junction to case IGBT thermal resistance		-	-	0.27	
FRED Pt chopper diode	Junction to case diode thermal resistance		-	-	2.25	
	Case to sink, flat, greased surface per module	R_{thCS}	-	0.06	-	$^\circ\text{C}/\text{W}$
	Mounting torque $\pm 10\%$ to heatsink ⁽¹⁾		-	-	4	Nm
	Approximate weight		-	65	-	g

Note

⁽¹⁾ A mounting compound is recommended and the torque should be rechecked after a period of 3 hours to allow for the spread of the compound.

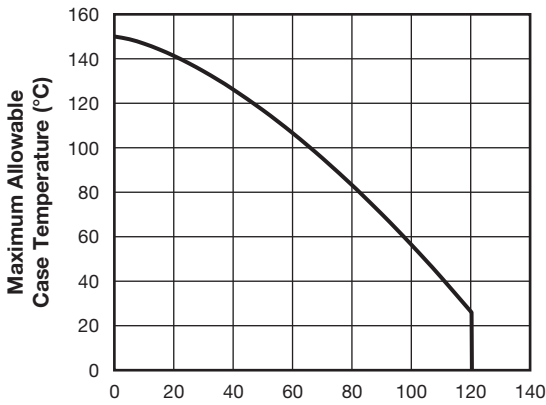

93412_01 **I_C - Continuous Collector Current (A)**

Fig. 1 - Maximum IGBT Continuous Collector Current vs. Case Temperature

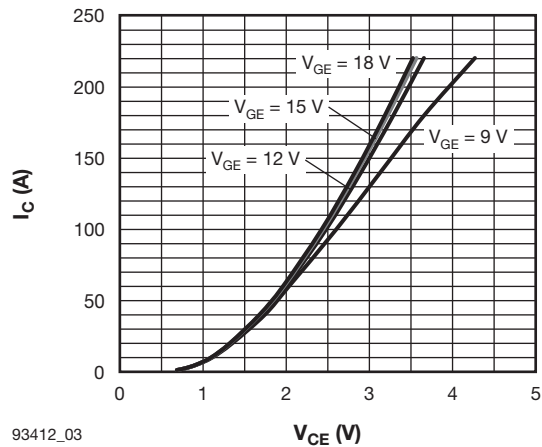

93412_03

Fig. 3 - Typical IGBT Output Characteristics, $T_J = 25\text{ }^\circ\text{C}$

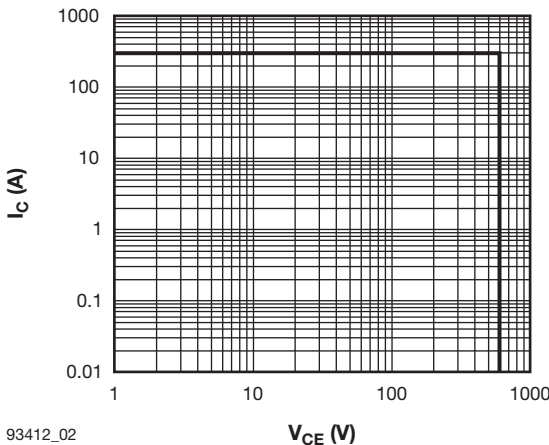

93412_02

Fig. 2 - IGBT Reverse BIAS SOA $T_J = 150\text{ }^\circ\text{C}$, $V_{GE} = 15\text{ V}$

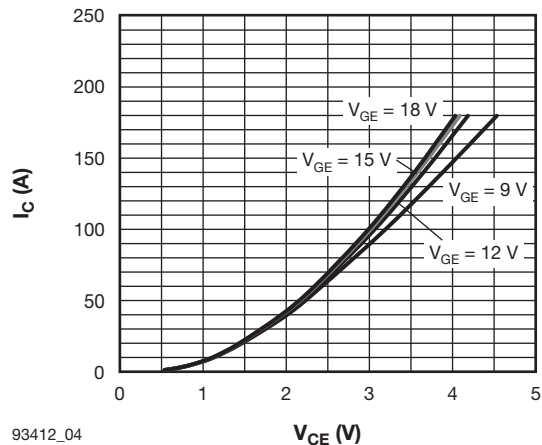

93412_04

Fig. 4 - Typical IGBT Output Characteristics, $T_J = 125\text{ }^\circ\text{C}$

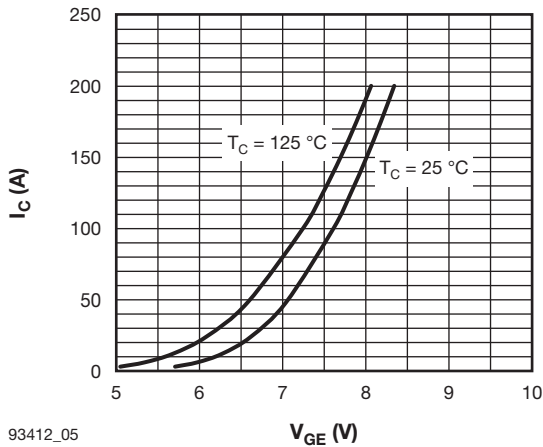

93412_05

Fig. 5 - Typical IGBT Transfer Characteristics, $T_J = 125\text{ }^\circ\text{C}$

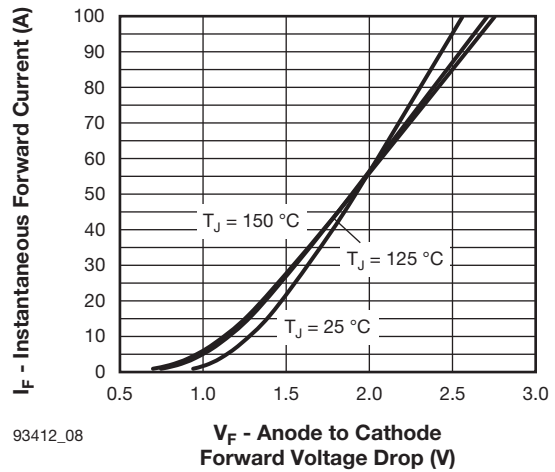

93412_08

Fig. 8 - Typical Diode Forward Voltage Characteristics of Antiparallel Diode, $t_p = 500\text{ }\mu\text{s}$

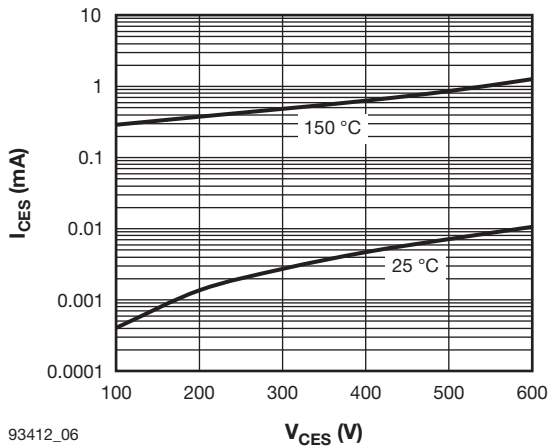

93412_06

Fig. 6 - Typical IGBT Zero Gate Voltage Collector Current

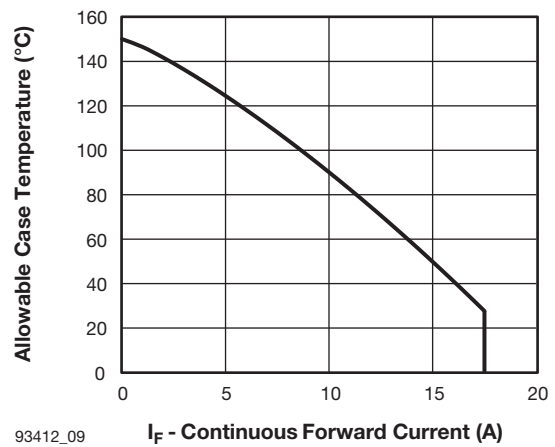

93412_09

Fig. 9 - Maximum Continuous Forward Current vs. Case Temperature Antiparallel Diode

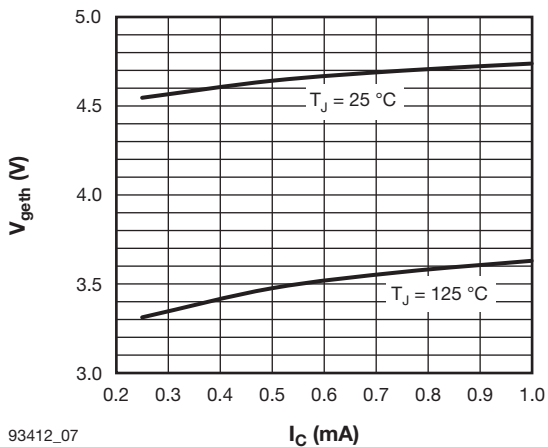

93412_07

Fig. 7 - Typical IGBT Gate Threshold Voltage

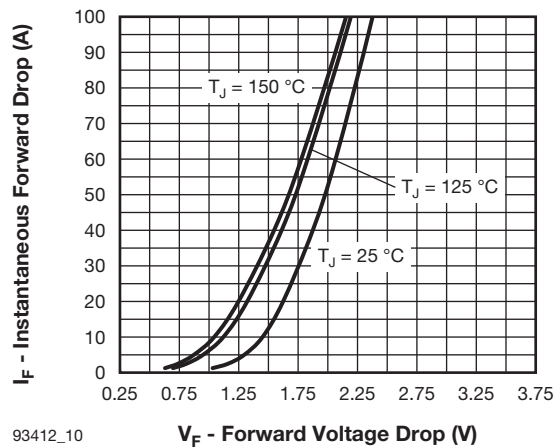

93412_10

Fig. 10 - Typical PFC Diode Forward Voltage

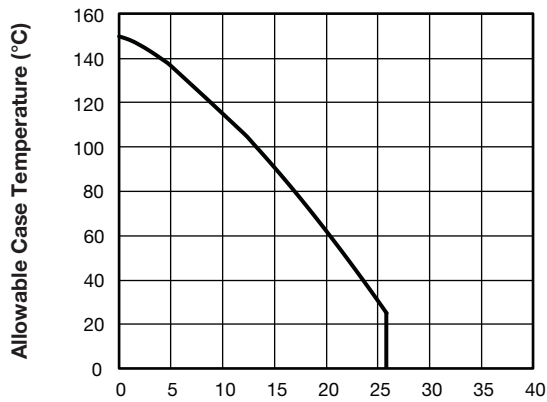

93412_11

I_F - Continuous Forward Current (A)

Fig. 11 - Maximum Continuous Forward Current vs. Case Temperature PFC Diode

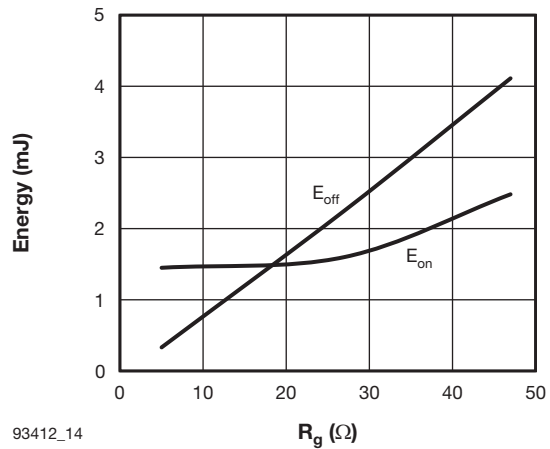

93412_14

Fig. 14 - Typical IGBT Energy Loss vs. R_g, T_J = 125 °C
I_C = 100 A, V_{CC} = 360 V, V_{GE} = 15 V, L = 500 μH, R_g = 5 Ω

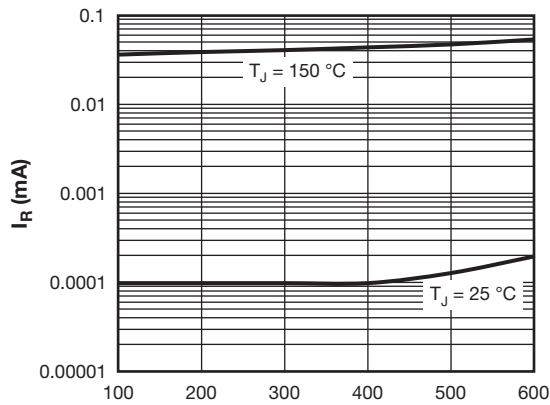

93412_12

Fig. 12 - Typical FRED Pt Chopper Diode Reverse Current vs. Reverse Voltage

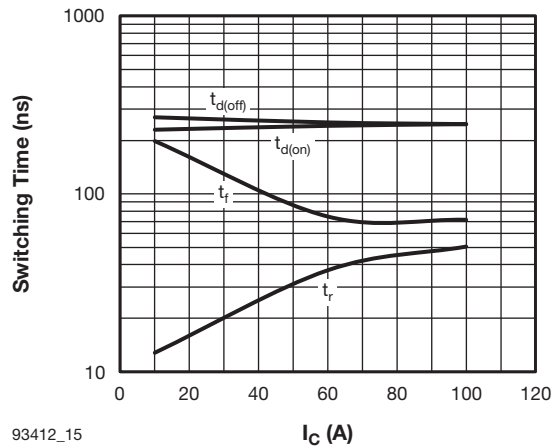

93412_15

Fig. 15 - Typical IGBT Switching Time vs. I_C
T_J = 125 °C, V_{DD} = 360 V, V_{GE} = 15 V, L = 500 μH, R_g = 5 Ω

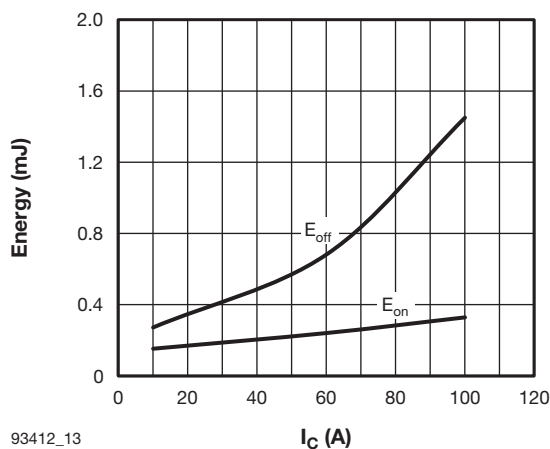

93412_13

Fig. 13 - Typical IGBT Energy Loss vs. I_C
T_J = 125 °C, V_{CC} = 360 V, V_{GE} = 15 V, L = 500 μH, R_g = 5 Ω

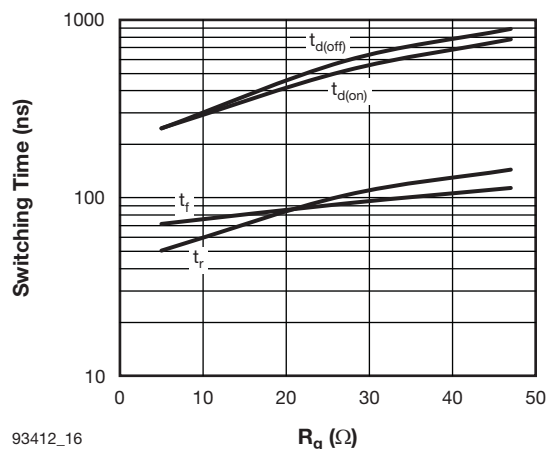

93412_16

Fig. 16 - Typical IGBT Switching Time vs. R_g, T_J = 125 °C
I_C = 100 A, V_{CE} = 360 V, V_{GE} = 15 V, L = 500 μH

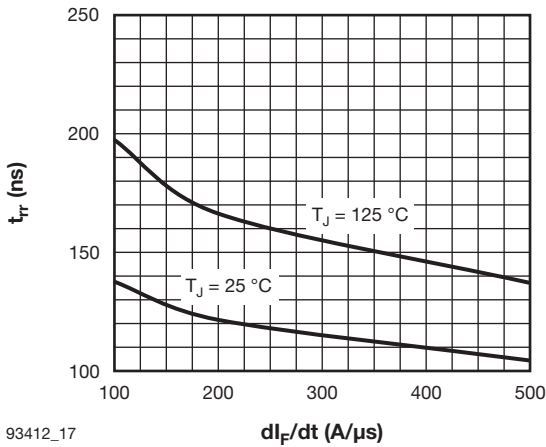

93412_17

Fig. 17 - Typical t_{rr} Antiparallel Diode vs. dl_F/dt
 $V_{rr} = 200\text{ V}$, $I_F = 60\text{ A}$

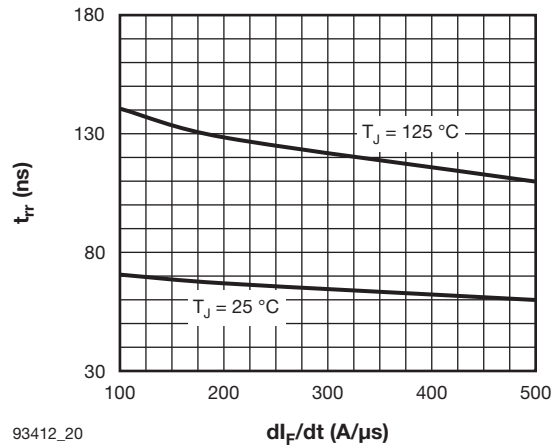

93412_20

Fig. 20 - Typical t_{rr} Chopper Diode vs. dl_F/dt
 $V_{rr} = 200\text{ V}$, $I_F = 60\text{ A}$

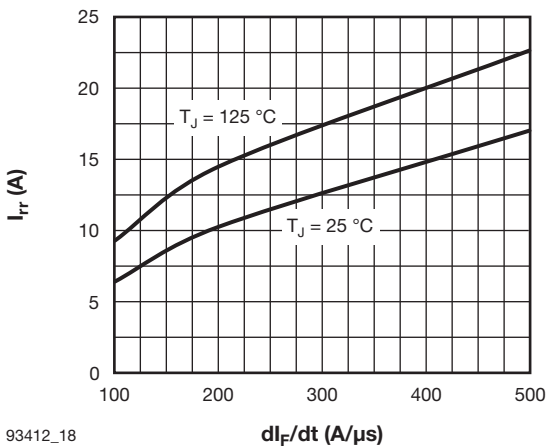

93412_18

Fig. 18 - Typical I_{rr} Antiparallel Diode vs. dl_F/dt
 $V_{rr} = 200\text{ V}$, $I_F = 60\text{ A}$

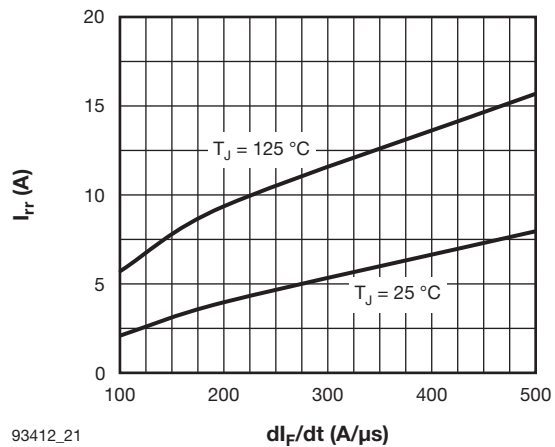

93412_21

Fig. 21 - Typical I_{rr} Chopper Diode vs. dl_F/dt
 $V_{rr} = 200\text{ V}$, $I_F = 60\text{ A}$

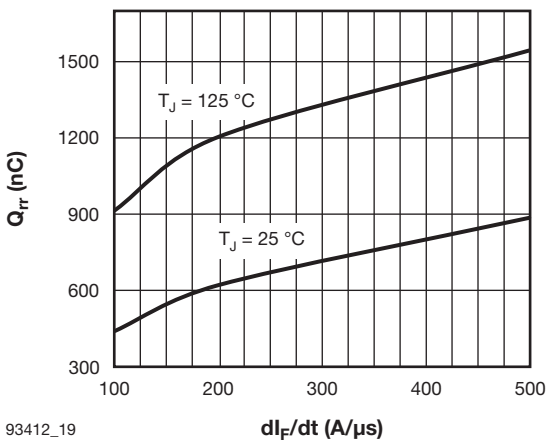

93412_19

Fig. 19 - Typical Q_{rr} Antiparallel Diode vs. dl_F/dt
 $V_{rr} = 200\text{ V}$, $I_F = 60\text{ A}$

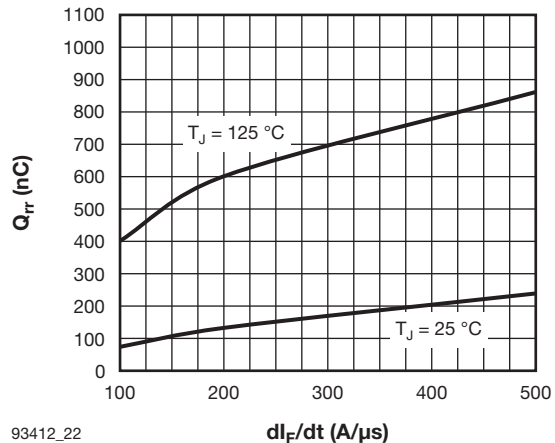

93412_22

Fig. 22 - Typical Q_{rr} Chopper Diode vs. dl_F/dt
 $V_{rr} = 200\text{ V}$, $I_F = 40\text{ A}$

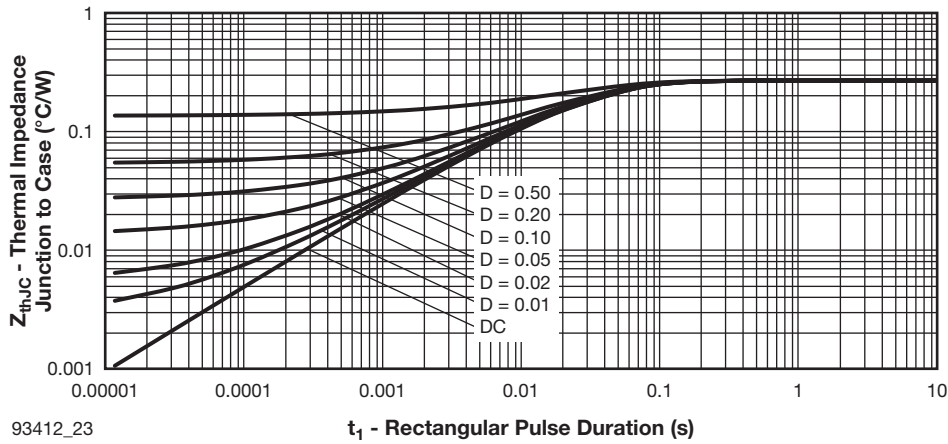

93412_23

Fig. 23 - Maximum Thermal Impedance Z_{thJC} Characteristics (IGBT)

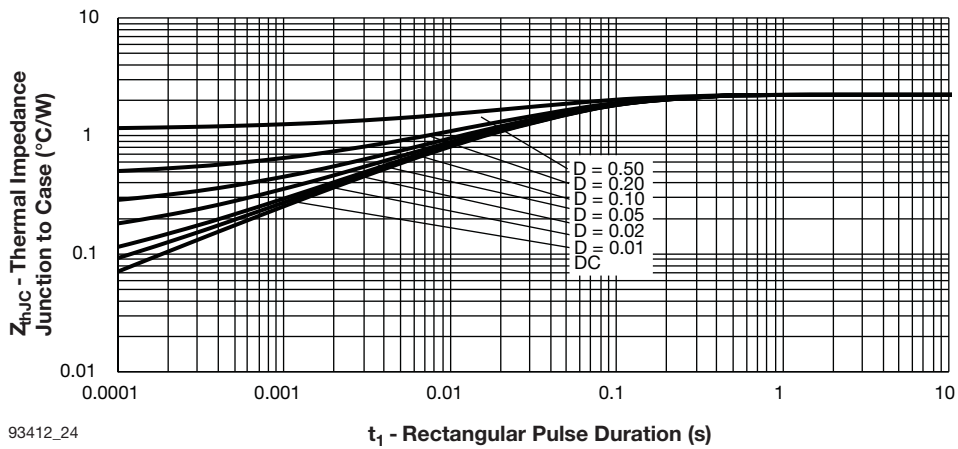

93412_24

Fig. 24 - Maximum Thermal Impedance Z_{thJC} Characteristics (PFC Diode)

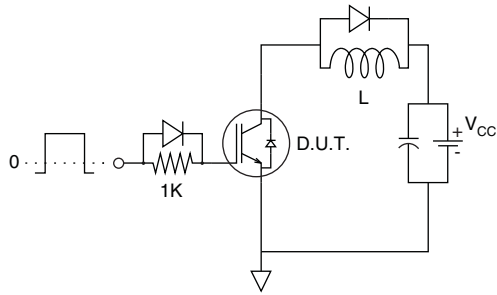

Fig. 25 - Gate Charge Circuit (Turn-Off)

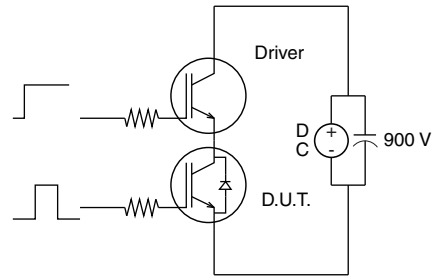

Fig. 27 - S.C. SOA Circuit

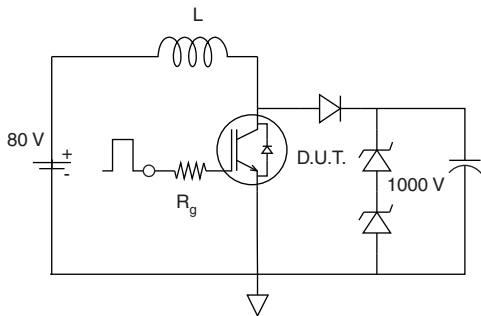

Fig. 26 - RBSOA Circuit

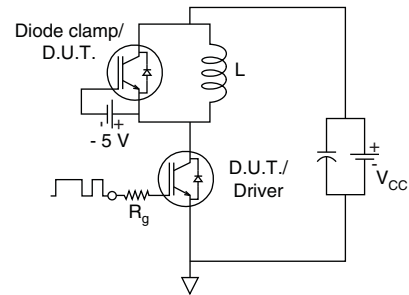

Fig. 28 - Switching Loss Circuit

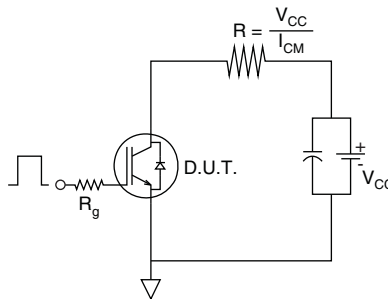
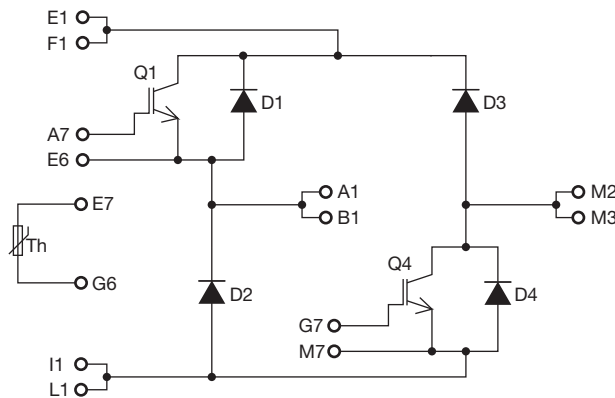

Fig. 29 - Resistive Load Circuit

CIRCUIT CONFIGURATION





ORDERING INFORMATION TABLE

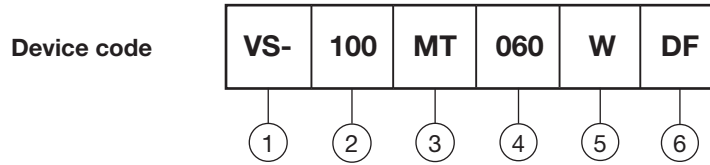

- 1** - Vishay Semiconductors product
- 2** - Current rating (100 = 100 A)
- 3** - Essential part number (MT = MTP package)
- 4** - Voltage code x 10 = voltage rating (example: 060 = 600 V)
- 5** - Die IGBT technology (W = warp speed IGBT)
- 6** - Circuit configuration (DF = dual forward)

LINKS TO RELATED DOCUMENTS	
Dimensions	www.vishay.com/doc?95383



MTP - Full Pin

DIMENSIONS in millimeters

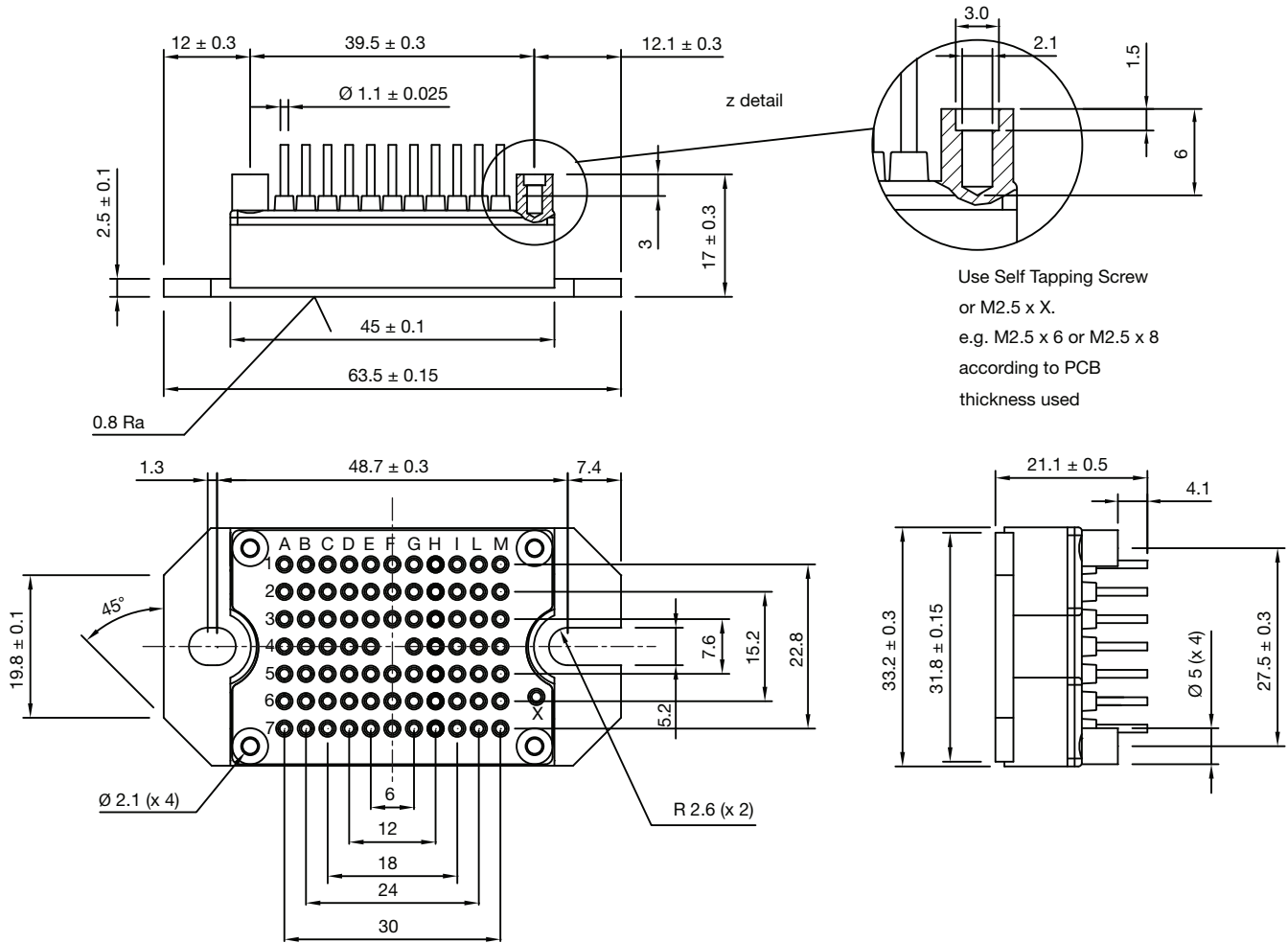

PINS POSITION
WITH TOLERANCE $\varnothing 0.6$



Disclaimer

ALL PRODUCT, PRODUCT SPECIFICATIONS AND DATA ARE SUBJECT TO CHANGE WITHOUT NOTICE TO IMPROVE RELIABILITY, FUNCTION OR DESIGN OR OTHERWISE.

Vishay Intertechnology, Inc., its affiliates, agents, and employees, and all persons acting on its or their behalf (collectively, "Vishay"), disclaim any and all liability for any errors, inaccuracies or incompleteness contained in any datasheet or in any other disclosure relating to any product.

Vishay makes no warranty, representation or guarantee regarding the suitability of the products for any particular purpose or the continuing production of any product. To the maximum extent permitted by applicable law, Vishay disclaims (i) any and all liability arising out of the application or use of any product, (ii) any and all liability, including without limitation special, consequential or incidental damages, and (iii) any and all implied warranties, including warranties of fitness for particular purpose, non-infringement and merchantability.

Statements regarding the suitability of products for certain types of applications are based on Vishay's knowledge of typical requirements that are often placed on Vishay products in generic applications. Such statements are not binding statements about the suitability of products for a particular application. It is the customer's responsibility to validate that a particular product with the properties described in the product specification is suitable for use in a particular application. Parameters provided in datasheets and / or specifications may vary in different applications and performance may vary over time. All operating parameters, including typical parameters, must be validated for each customer application by the customer's technical experts. Product specifications do not expand or otherwise modify Vishay's terms and conditions of purchase, including but not limited to the warranty expressed therein.

Except as expressly indicated in writing, Vishay products are not designed for use in medical, life-saving, or life-sustaining applications or for any other application in which the failure of the Vishay product could result in personal injury or death. Customers using or selling Vishay products not expressly indicated for use in such applications do so at their own risk. Please contact authorized Vishay personnel to obtain written terms and conditions regarding products designed for such applications.

No license, express or implied, by estoppel or otherwise, to any intellectual property rights is granted by this document or by any conduct of Vishay. Product names and markings noted herein may be trademarks of their respective owners.