

Single Phase Bridge (Power Modules), 25 A/35 A



D-34

FEATURES

- Universal, 3 way terminals: push-on, wrap around or solder
- High thermal conductivity package, electrically insulated case
- Center hole fixing
- Excellent power/volume ratio
- Nickel plated terminals solderable using lead (Pb)-free solder; solder alloy Sn/Ag/Cu (SAC305); solder temperature 260 to 275 °C
- UL E300359 approved 
- RoHS compliant
- Designed and qualified for industrial and consumer level



RoHS
COMPLIANT

PRODUCT SUMMARY

I_o	25 A/35 A
-------	-----------

DESCRIPTION

A range of extremely compact, encapsulated single phase bridge rectifiers offering efficient and reliable operation. They are intended for use in general purpose and instrumentation applications.

MAJOR RATINGS AND CHARACTERISTICS

SYMBOL	CHARACTERISTICS	26MB-A	36MB-A	UNITS
I_o		25	35	A
	T_c	70	55	°C
I_{FSM}	50 Hz	400	475	A
	60 Hz	420	500	
I^2t	50 Hz	790	1130	A ² s
	60 Hz	725	1030	
V_{RRM}	Range	1400 to 1600	1400 to 1600	V
T_J		- 55 to 150	- 55 to 150	°C

ELECTRICAL SPECIFICATIONS

VOLTAGE RATINGS

TYPE NUMBER	VOLTAGE CODE	V_{RRM} , MAXIMUM REPETITIVE PEAK REVERSE VOLTAGE V	V_{RSM} , MAXIMUM NON-REPETITIVE PEAK REVERSE VOLTAGE V	I_{RRM} MAXIMUM AT T_J MAXIMUM mA
26MB..A	140	1400	1500	2
36MB..A	160	1600	1700	

FORWARD CONDUCTION							
PARAMETER	SYMBOL	TEST CONDITIONS		26MB-A	36MB-A	UNITS	
Maximum DC output current at case temperature	I_o	Resistive or inductive load		25	35	A	
		Capacitive load		20	28		
				65	60	°C	
Maximum peak, one cycle non-repetitive forward current	I_{FSM}	t = 10 ms	No voltage reapplied	Initial $T_J = T_J$ maximum	400	475	A
		t = 8.3 ms					
		t = 10 ms	100 % V_{RRM} reapplied		335	400	
		t = 8.3 ms			350	420	
Maximum I^2t for fusing	I^2t	t = 10 ms	No voltage reapplied		790	1130	A ² s
		t = 8.3 ms					
		t = 10 ms	100 % V_{RRM} reapplied		560	800	
		t = 8.3 ms			512	730	
Maximum $I^2\sqrt{t}$ for fusing	$I^2\sqrt{t}$	I^2t for time $t_x = I^2\sqrt{t} \times \sqrt{t_x}$; $0.1 \leq t_x \leq 10$ ms, $V_{RRM} = 0$ V		5.6	11.3	kA ² √s	
Low level of threshold voltage	$V_{F(TO)1}$	$(16.7\% \times \pi \times I_{F(AV)} < I < \pi \times I_{F(AV)})$, T_J maximum		0.70	0.74	V	
High level of threshold voltage	$V_{F(TO)2}$	$(I > \pi \times I_{F(AV)})$, T_J maximum		0.75	0.79		
Low level forward slope resistance	r_{t1}	$(16.7\% \times \pi \times I_{F(AV)} < I < \pi \times I_{F(AV)})$, T_J maximum		7.0	5.5	mΩ	
High level forward slope resistance	r_{t2}	$(I > \pi \times I_{F(AV)})$, T_J maximum		6.4	5.2		
Maximum forward voltage drop	V_{FM}	$T_J = 25$ °C, $I_{FM} = 40$ Apk (26MB)		$t_p = 400$ μs	1.25	1.3	V
		$T_J = 25$ °C, $I_{FM} = 55$ Apk (36MB)					
Maximum DC reverse current per diode	I_{RRM}	$T_J = 25$ °C, at V_{RRM}		10	10	μA	
RMS isolation voltage base plate	V_{ISOL}	f = 50 Hz, t = 1 s		2700	2700	V	

THERMAL AND MECHANICAL SPECIFICATIONS						
PARAMETER	SYMBOL	TEST CONDITIONS		26MB-A	36MB-A	UNITS
Junction and storage temperature range	T_J, T_{Stg}			- 55 to 150		°C
Maximum thermal resistance, junction to case per bridge	R_{thJC}			1.7	1.35	K/W
Maximum thermal resistance, case to heatsink	R_{thCS}	Mounting surface, smooth, flat and greased		0.2		
Mounting torque ± 10 %		Bridge to heatsink		2.0		Nm
Approximate weight				20		g



MB High Voltage Series

Single Phase Bridge
(Power Modules), 25 A/35 A

Vishay High Power Products

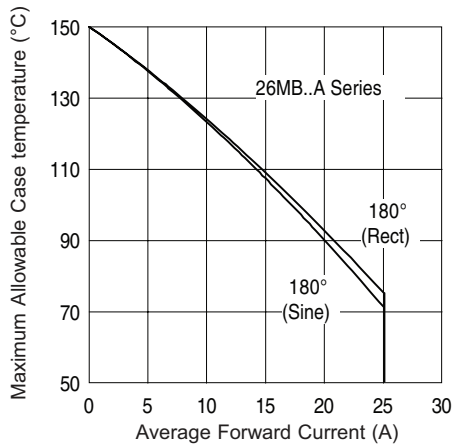

Fig. 1 - Current Ratings Characteristics

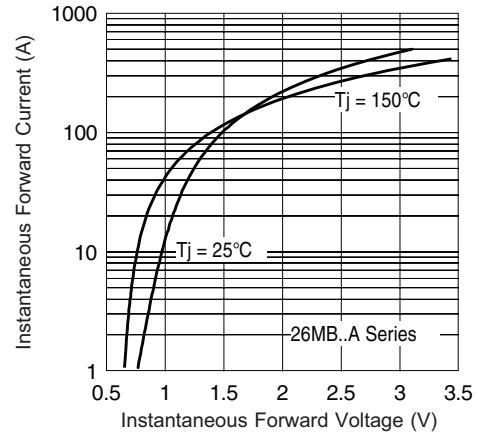

Fig. 2 - Forward Voltage Drop Characteristics

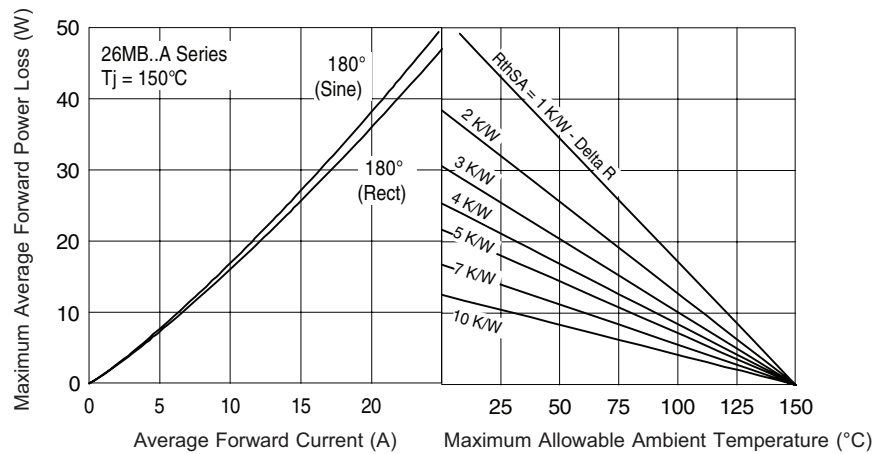

Fig. 3 - Total Power Loss Characteristics

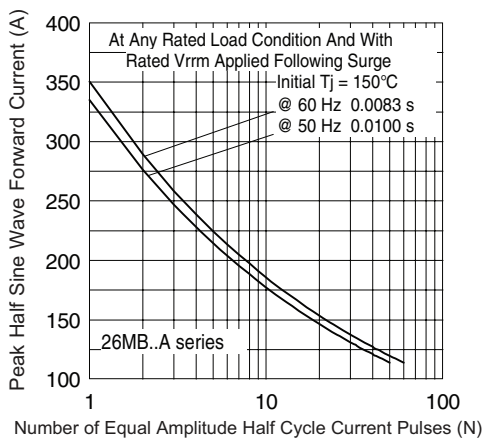

Fig. 4 - Maximum Non-Repetitive Surge Current

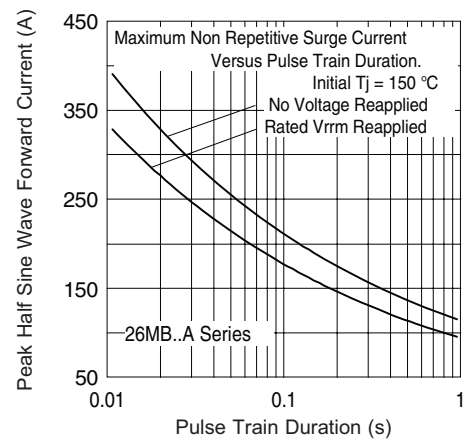

Fig. 5 - Maximum Non-Repetitive Surge Current

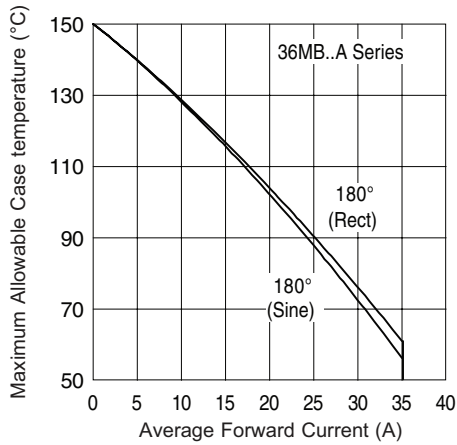

Fig. 6 - Current Ratings Characteristics

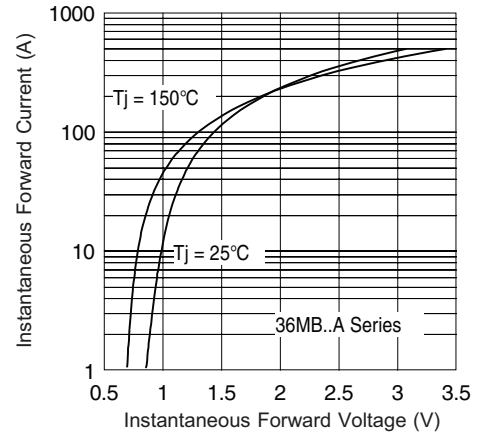

Fig. 7 - Forward Voltage Drop Characteristics

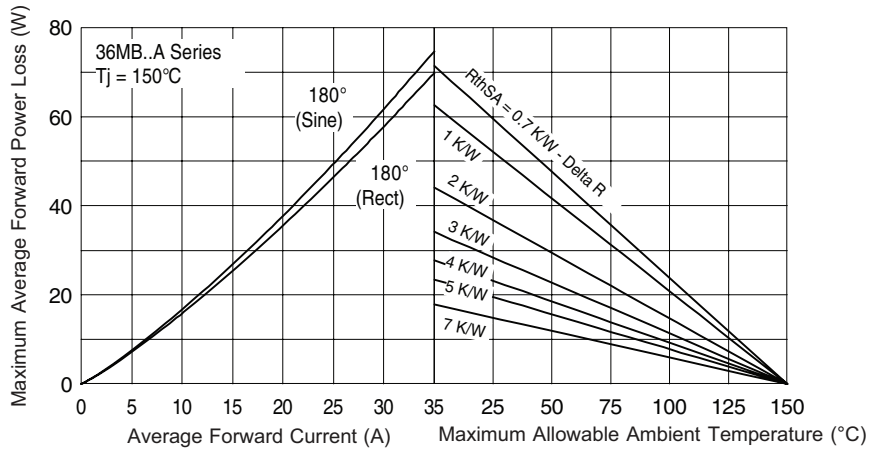

Fig. 8 - Total Power Loss Characteristics

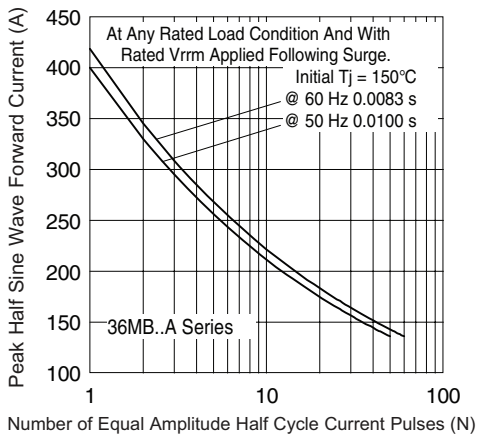

Fig. 9 - Maximum Non-Repetitive Surge Current

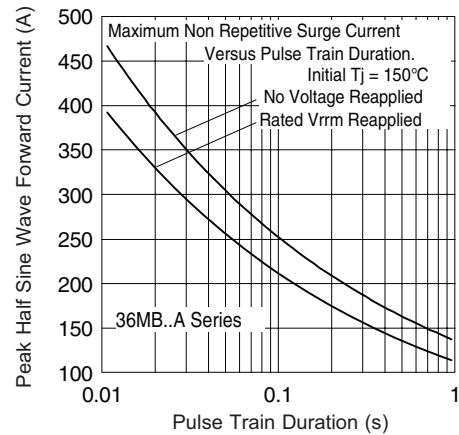
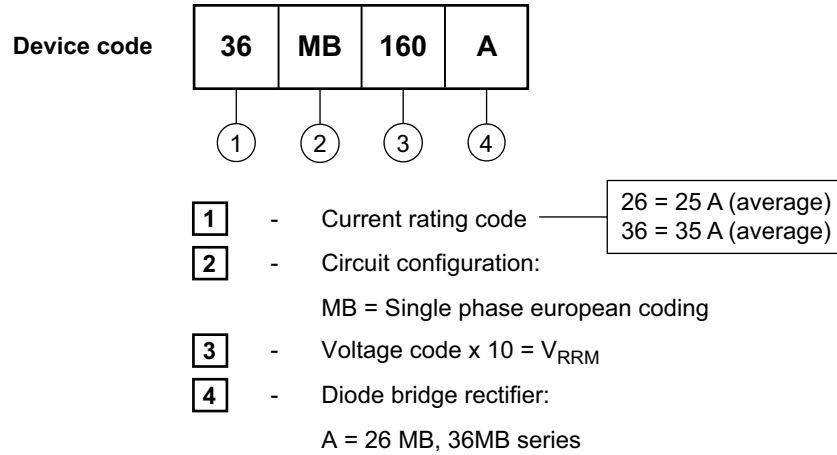

Fig. 10 - Maximum Non-Repetitive Surge Current



ORDERING INFORMATION TABLE



CIRCUIT CONFIGURATION

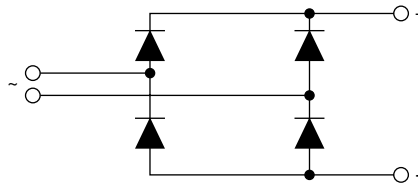

LINKS TO RELATED DOCUMENTS	
Dimensions	http://www.vishay.com/doc?95326

D-34

DIMENSIONS in millimeters (inches)

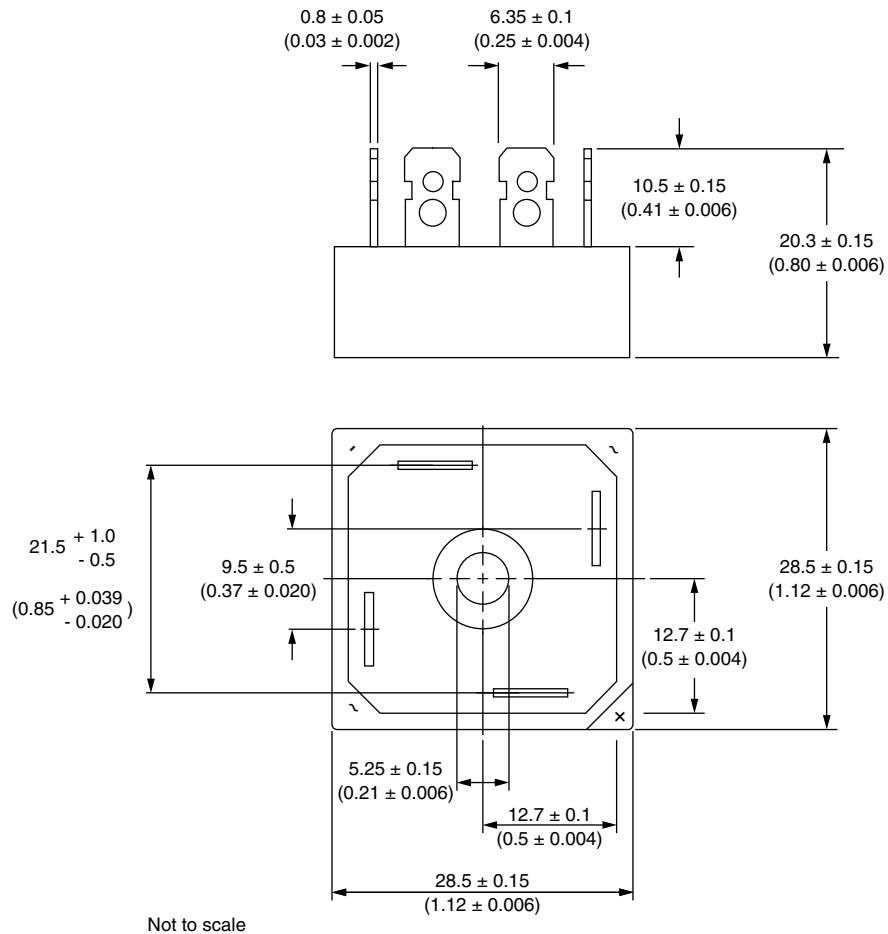

Suggested plugging force:
200 N max; axially applied to fast-on terminals



Disclaimer

ALL PRODUCT, PRODUCT SPECIFICATIONS AND DATA ARE SUBJECT TO CHANGE WITHOUT NOTICE TO IMPROVE RELIABILITY, FUNCTION OR DESIGN OR OTHERWISE.

Vishay Intertechnology, Inc., its affiliates, agents, and employees, and all persons acting on its or their behalf (collectively, "Vishay"), disclaim any and all liability for any errors, inaccuracies or incompleteness contained in any datasheet or in any other disclosure relating to any product.

Vishay makes no warranty, representation or guarantee regarding the suitability of the products for any particular purpose or the continuing production of any product. To the maximum extent permitted by applicable law, Vishay disclaims (i) any and all liability arising out of the application or use of any product, (ii) any and all liability, including without limitation special, consequential or incidental damages, and (iii) any and all implied warranties, including warranties of fitness for particular purpose, non-infringement and merchantability.

Statements regarding the suitability of products for certain types of applications are based on Vishay's knowledge of typical requirements that are often placed on Vishay products in generic applications. Such statements are not binding statements about the suitability of products for a particular application. It is the customer's responsibility to validate that a particular product with the properties described in the product specification is suitable for use in a particular application. Parameters provided in datasheets and/or specifications may vary in different applications and performance may vary over time. All operating parameters, including typical parameters, must be validated for each customer application by the customer's technical experts. Product specifications do not expand or otherwise modify Vishay's terms and conditions of purchase, including but not limited to the warranty expressed therein.

Except as expressly indicated in writing, Vishay products are not designed for use in medical, life-saving, or life-sustaining applications or for any other application in which the failure of the Vishay product could result in personal injury or death. Customers using or selling Vishay products not expressly indicated for use in such applications do so at their own risk and agree to fully indemnify and hold Vishay and its distributors harmless from and against any and all claims, liabilities, expenses and damages arising or resulting in connection with such use or sale, including attorneys fees, even if such claim alleges that Vishay or its distributor was negligent regarding the design or manufacture of the part. Please contact authorized Vishay personnel to obtain written terms and conditions regarding products designed for such applications.

No license, express or implied, by estoppel or otherwise, to any intellectual property rights is granted by this document or by any conduct of Vishay. Product names and markings noted herein may be trademarks of their respective owners.

Material Category Policy

Vishay Intertechnology, Inc. hereby certifies that all its products that are identified as RoHS-Compliant fulfill the definitions and restrictions defined under Directive 2011/65/EU of The European Parliament and of the Council of June 8, 2011 on the restriction of the use of certain hazardous substances in electrical and electronic equipment (EEE) - recast, unless otherwise specified as non-compliant.

Please note that some Vishay documentation may still make reference to RoHS Directive 2002/95/EC. We confirm that all the products identified as being compliant to Directive 2002/95/EC conform to Directive 2011/65/EU.