

Ultrafast Rectifier, 2 x 8 A FRED Pt®

VS-MURB1620CTPbF

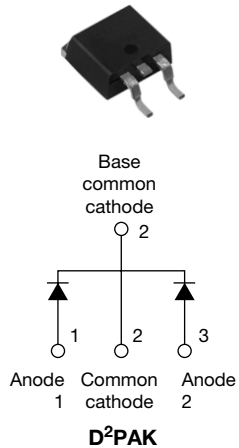

VS-MURB1620CT-1PbF

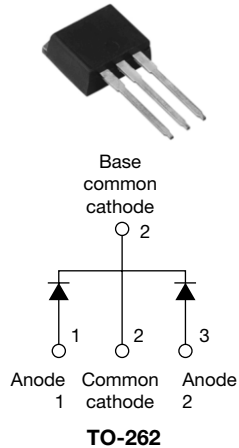

FEATURES

- Ultrafast recovery time
- Low forward voltage drop
- Low leakage current
- 175 °C operating junction temperature
- Meets MSL level 1, per J-STD-020, LF maximum peak of 260 °C
- Halogen-free according to IEC 61249-2-21 definition
- Compliant to RoHS directive 2002/95/EC
- AEC-Q101 qualified



RoHS
COMPLIANT
HALOGEN
FREE

DESCRIPTION/APPLICATIONS

MUR.. series are the state of the art ultrafast recovery rectifiers specifically designed with optimized performance of forward voltage drop and ultrafast recovery time.

The planar structure and the platinum doped life time control, guarantee the best overall performance, ruggedness and reliability characteristics.

These devices are intended for use in the output rectification stage of SMPS, UPS, dc-to-dc converters as well as freewheeling diode in low voltage inverters and chopper motor drives.

Their extremely optimized stored charge and low recovery current minimize the switching losses and reduce over dissipation in the switching element and snubbers.

PRODUCT SUMMARY

| | |
|-------------|---------|
| t_{rr} | 25 ns |
| $I_{F(AV)}$ | 2 x 8 A |
| V_R | 200 V |

ABSOLUTE MAXIMUM RATINGS

| PARAMETER | SYMBOL | TEST CONDITIONS | MAX. | UNITS |
|---|----------------|--|-------------------------------------|-------|
| Peak repetitive reverse voltage | V_{RRM} | | 200 | V |
| Average rectified forward current | $I_{F(AV)}$ | per leg | 8.0 | A |
| | | total device | Rated V_R , $T_C = 150\text{ °C}$ | |
| Non-repetitive peak surge current per leg | I_{FSM} | | 100 | |
| Peak repetitive forward current per leg | I_{FM} | Rated V_R , square wave, 20 kHz, $T_C = 150\text{ °C}$ | 16 | |
| Operating junction and storage temperatures | T_J, T_{Stg} | | - 65 to 175 | °C |

ELECTRICAL SPECIFICATIONS ($T_J = 25\text{ °C}$ unless otherwise specified)

| PARAMETER | SYMBOL | TEST CONDITIONS | MIN. | TYP. | MAX. | UNITS |
|-------------------------------------|---------------|---|------|------|-------|---------------|
| Breakdown voltage, blocking voltage | V_{BR}, V_R | $I_R = 100\text{ }\mu\text{A}$ | 200 | - | - | V |
| Forward voltage | V_F | $I_F = 8\text{ A}$ | - | - | 0.975 | |
| | | $I_F = 8\text{ A}, T_J = 150\text{ °C}$ | - | - | 0.895 | |
| Reverse leakage current | I_R | $V_R = V_R\text{ rated}$ | - | - | 5 | μA |
| | | $T_J = 150\text{ °C}, V_R = V_R\text{ rated}$ | - | - | 250 | |
| Junction capacitance | C_T | $V_R = 200\text{ V}$ | - | 25 | - | pF |
| Series inductance | L_S | Measured lead to lead 5 mm from package body | - | 8.0 | - | nH |

VS-MURB1620CTPbF, VS-MURB1620CT-1PbF



Vishay High Power Products

Ultrafast Rectifier,
2 x 8 A FRED Pt®

| DYNAMIC RECOVERY CHARACTERISTICS (T _J = 25 °C unless otherwise specified) | | | | | | |
|--|------------------|--|------|------|------|-------|
| PARAMETER | SYMBOL | TEST CONDITIONS | MIN. | TYP. | MAX. | UNITS |
| Reverse recovery time | t _{rr} | I _F = 1.0 A, di _F /dt = 50 A/μs, V _R = 30 V | - | - | 35 | ns |
| | | I _F = 0.5 A, I _R = 1.0 A, I _{REC} = 0.25 A | - | - | 25 | |
| | | T _J = 25 °C | - | 20 | - | |
| | | T _J = 125 °C | - | 34 | - | |
| Peak recovery current | I _{RRM} | T _J = 25 °C | - | 1.7 | - | A |
| | | T _J = 125 °C | - | 4.2 | - | |
| Reverse recovery charge | Q _{rr} | T _J = 25 °C | - | 23 | - | nC |
| | | T _J = 125 °C | - | 75 | - | |

| THERMAL - MECHANICAL SPECIFICATIONS | | | | | | |
|---|-----------------------------------|--|--------------|------|------------|------------------------|
| PARAMETER | SYMBOL | TEST CONDITIONS | MIN. | TYP. | MAX. | UNITS |
| Maximum junction and storage temperature range | T _J , T _{Stg} | | - 65 | - | 175 | °C |
| Thermal resistance, junction to case per leg | R _{thJC} | | - | - | 3.0 | °C/W |
| Thermal resistance, junction to ambient per leg | R _{thJA} | | - | - | 50 | |
| Thermal resistance, case to heatsink | R _{thCS} | Mounting surface, flat, smooth and greased | - | 0.5 | - | |
| Weight | | | - | 2.0 | - | g |
| | | | - | 0.07 | - | oz. |
| Mounting torque | | | 6.0 (5.0) | - | 12 (10) | kgf · cm (lbf · in) |
| Marking device | | Case style D ² PAK | MURB1620CT | | | |
| | | Case style TO-262 | MURB1620CT-1 | | | |



VS-MURB1620CTPbF, VS-MURB1620CT-1PbF

Ultrafast Rectifier,
2 x 8 A FRED Pt®

Vishay High Power Products

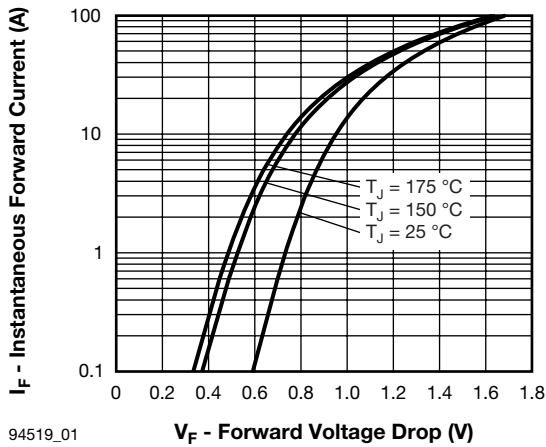

94519_01

Fig. 1 - Typical Forward Voltage Drop Characteristics

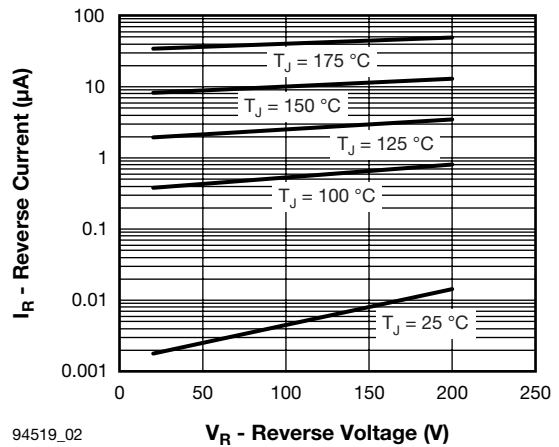

94519_02

Fig. 2 - Typical Values of Reverse Current vs. Reverse Voltage

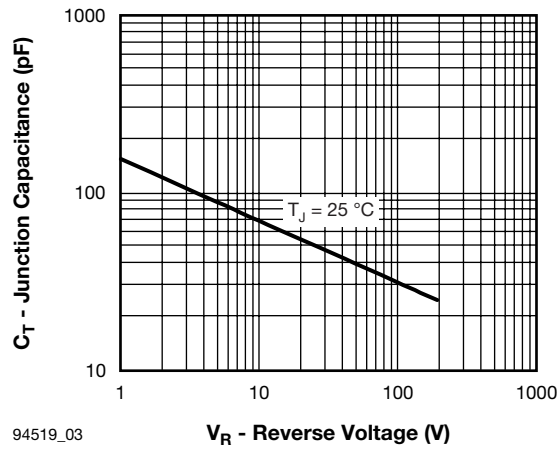

94519_03

Fig. 3 - Typical Junction Capacitance vs. Reverse Voltage

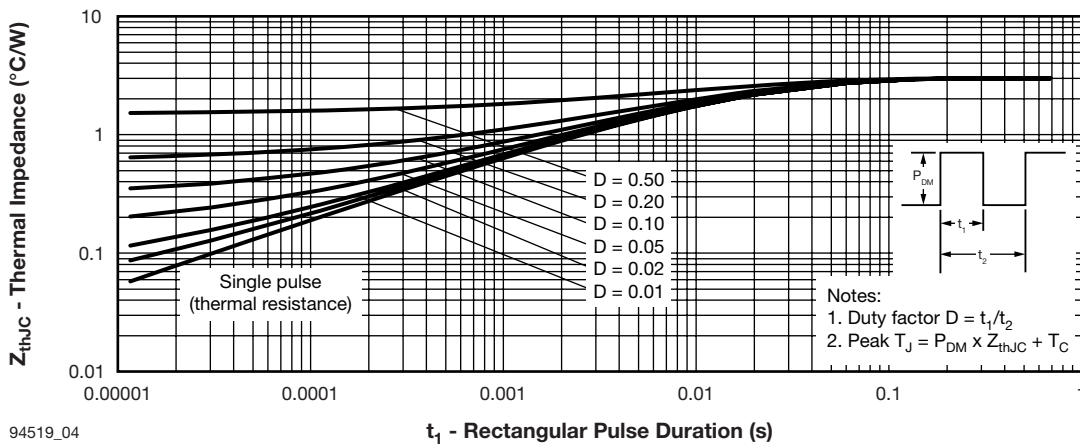

94519_04

Fig. 4 - Maximum Thermal Impedance Z_{thJC} Characteristics

VS-MURB1620CTPbF, VS-MURB1620CT-1PbF



Vishay High Power Products

Ultrafast Rectifier,
2 x 8 A FRED Pt®

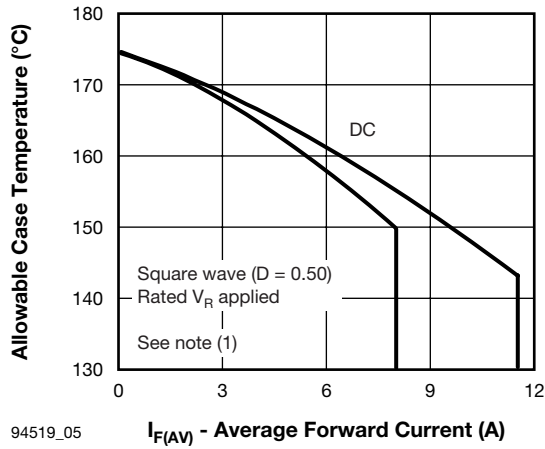

Fig. 5 - Maximum Allowable Case Temperature vs. Average Forward Current

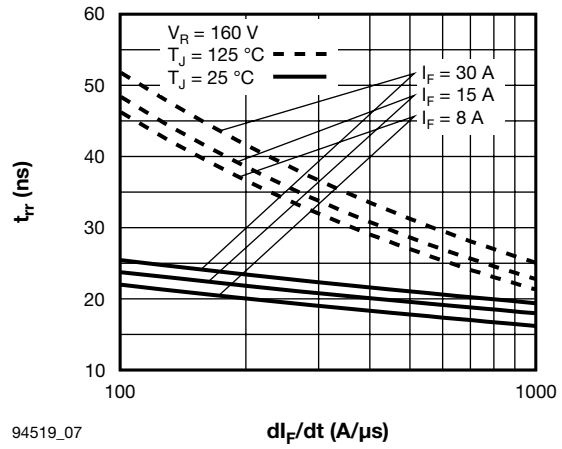

Fig. 7 - Typical Reverse Recovery Time vs. di_F/dt

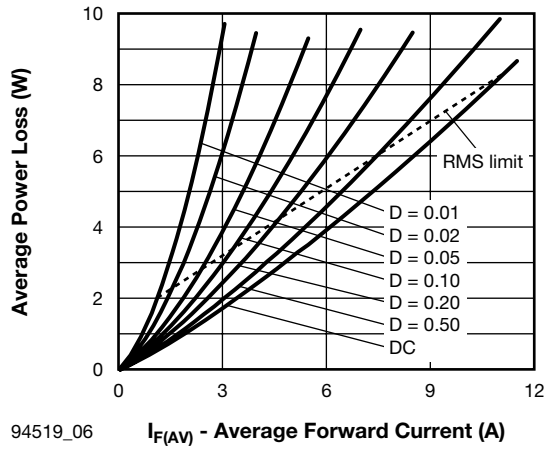

Fig. 6 - Forward Power Loss Characteristics

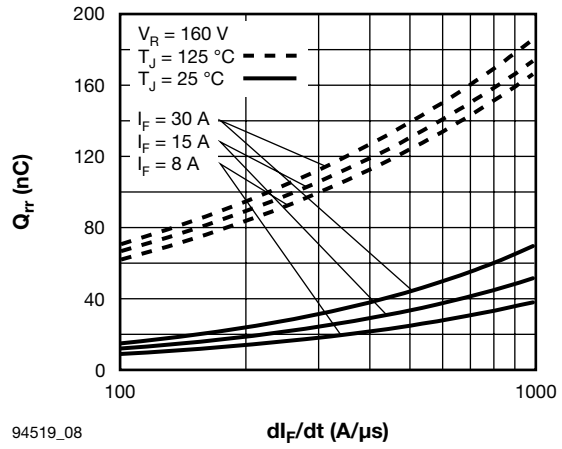

Fig. 8 - Typical Stored Charge vs. di_F/dt

Note

- (1) Formula used: $T_C = T_J - (P_d + P_{d_{REV}}) \times R_{thJC}$;
 P_d = Forward power loss = $I_{F(AV)} \times V_{FM}$ at $(I_{F(AV)}/D)$ (see fig. 6);
 $P_{d_{REV}}$ = Inverse power loss = $V_{R1} \times I_R (1 - D)$; I_R at V_{R1} = Rated V_R

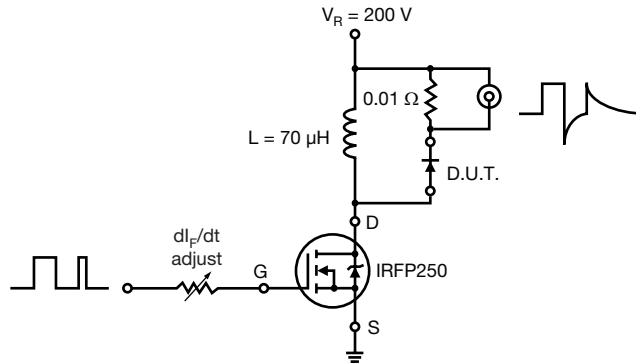
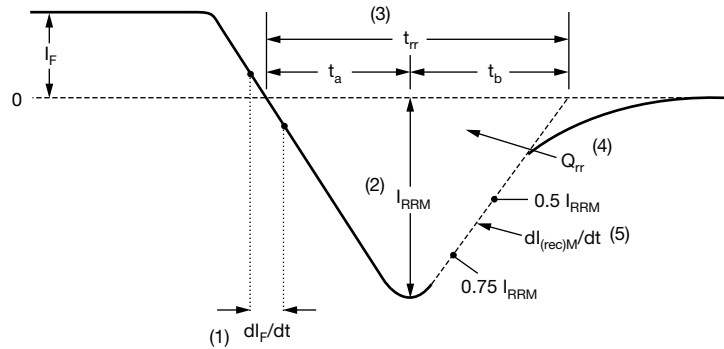

Fig. 9 - Reverse Recovery Parameter Test Circuit



(1) di_F/dt - rate of change of current through zero crossing

(2) I_{RRM} - peak reverse recovery current

(3) t_{rr} - reverse recovery time measured from zero crossing point of negative going I_F to point where a line passing through $0.75 I_{RRM}$ and $0.50 I_{RRM}$ extrapolated to zero current.

(4) Q_{rr} - area under curve defined by t_{rr} and I_{RRM}

$$Q_{rr} = \frac{t_{rr} \times I_{RRM}}{2}$$

(5) $di_{(rec)M}/dt$ - peak rate of change of current during t_b portion of t_{rr}

Fig. 10 - Reverse Recovery Waveform and Definitions

VS-MURB1620CTPbF, VS-MURB1620CT-1PbF



Vishay High Power Products

Ultrafast Rectifier,
2 x 8 A FRED Pt®

ORDERING INFORMATION TABLE

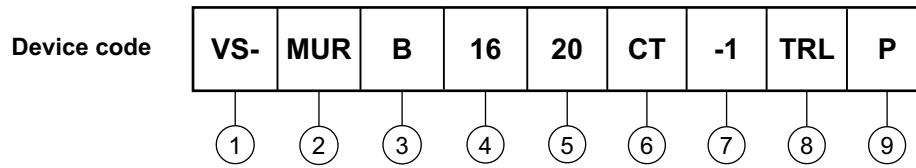

- 1** - HPP product suffix
- 2** - Ultrafast MUR series
- 3** - B = D²PAK/TO-262
- 4** - Current rating (16 = 16 A)
- 5** - Voltage rating (20 = 200 V)
- 6** - CT = Center tap (dual)
- 7** -
 - None = D²PAK
 - -1 = TO-262
- 8** -
 - None = Tube (50 pieces)
 - TRL = Tape and reel (left oriented, for D²PAK package)
 - TRR = Tape and reel (right oriented, for D²PAK package)
- 9** -
 - PbF = Lead (Pb)-free (for TO-262 and D²PAK tube)
 - P = Lead (Pb)-free (for D²PAK TRR and TRL)

| LINKS TO RELATED DOCUMENTS | |
|----------------------------|--|
| Dimensions | www.vishay.com/doc?95014 |
| Part marking information | www.vishay.com/doc?95008 |
| Packaging information | www.vishay.com/doc?95032 |

D²PAK, TO-262

DIMENSIONS FOR D²PAK in millimeters and inches

Conforms to JEDEC outline D²PAK (SMD-220)



| SYMBOL | MILLIMETERS | | INCHES | | NOTES |
|--------|-------------|-------|--------|-------|-------|
| | MIN. | MAX. | MIN. | MAX. | |
| A | 4.06 | 4.83 | 0.160 | 0.190 | |
| A1 | 0.00 | 0.254 | 0.000 | 0.010 | |
| b | 0.51 | 0.99 | 0.020 | 0.039 | |
| b1 | 0.51 | 0.89 | 0.020 | 0.035 | 4 |
| b2 | 1.14 | 1.78 | 0.045 | 0.070 | |
| b3 | 1.14 | 1.73 | 0.045 | 0.068 | 4 |
| c | 0.38 | 0.74 | 0.015 | 0.029 | |
| c1 | 0.38 | 0.58 | 0.015 | 0.023 | 4 |
| c2 | 1.14 | 1.65 | 0.045 | 0.065 | |
| D | 8.51 | 9.65 | 0.335 | 0.380 | 2 |

| SYMBOL | MILLIMETERS | | INCHES | | NOTES |
|--------|-------------|-------|-----------|-------|-------|
| | MIN. | MAX. | MIN. | MAX. | |
| D1 | 6.86 | 8.00 | 0.270 | 0.315 | 3 |
| E | 9.65 | 10.67 | 0.380 | 0.420 | 2, 3 |
| E1 | 7.90 | 8.80 | 0.311 | 0.346 | 3 |
| e | 2.54 BSC | | 0.100 BSC | | |
| H | 14.61 | 15.88 | 0.575 | 0.625 | |
| L | 1.78 | 2.79 | 0.070 | 0.110 | |
| L1 | - | 1.65 | - | 0.066 | 3 |
| L2 | 1.27 | 1.78 | 0.050 | 0.070 | |
| L3 | 0.25 BSC | | 0.010 BSC | | |
| L4 | 4.78 | 5.28 | 0.188 | 0.208 | |

Notes

- (1) Dimensioning and tolerancing per ASME Y14.5 M-1994
- (2) Dimension D and E do not include mold flash. Mold flash shall not exceed 0.127 mm (0.005") per side. These dimensions are measured at the outmost extremes of the plastic body
- (3) Thermal pad contour optional within dimension E, L1, D1 and E1
- (4) Dimension b1 and c1 apply to base metal only
- (5) Datum A and B to be determined at datum plane H
- (6) Controlling dimension: inch

- (7) Outline conforms to JEDEC outline TO-263AB

DIMENSIONS FOR TO-262 in millimeters and inches



| SYMBOL | MILLIMETERS | | INCHES | | NOTES |
|--------|-------------|-------|-----------|-------|-------|
| | MIN. | MAX. | MIN. | MAX. | |
| A | 4.06 | 4.83 | 0.160 | 0.190 | |
| A1 | 2.03 | 3.02 | 0.080 | 0.119 | |
| b | 0.51 | 0.99 | 0.020 | 0.039 | |
| b1 | 0.51 | 0.89 | 0.020 | 0.035 | 4 |
| b2 | 1.14 | 1.78 | 0.045 | 0.070 | |
| b3 | 1.14 | 1.73 | 0.045 | 0.068 | 4 |
| c | 0.38 | 0.74 | 0.015 | 0.029 | |
| c1 | 0.38 | 0.58 | 0.015 | 0.023 | 4 |
| c2 | 1.14 | 1.65 | 0.045 | 0.065 | |
| D | 8.51 | 9.65 | 0.335 | 0.380 | 2 |
| D1 | 6.86 | 8.00 | 0.270 | 0.315 | 3 |
| E | 9.65 | 10.67 | 0.380 | 0.420 | 2, 3 |
| E1 | 7.90 | 8.80 | 0.311 | 0.346 | 3 |
| e | 2.54 BSC | | 0.100 BSC | | |
| L | 13.46 | 14.10 | 0.530 | 0.555 | |
| L1 | - | 1.65 | - | 0.065 | 3 |
| L2 | 3.56 | 3.71 | 0.140 | 0.146 | |

Notes

- (1) Dimensioning and tolerancing as per ASME Y14.5M-1994
- (2) Dimension D and E do not include mold flash. Mold flash shall not exceed 0.127 mm (0.005") per side. These dimensions are measured at the outmost extremes of the plastic body
- (3) Thermal pad contour optional within dimension E, L1, D1 and E1
- (4) Dimension b1 and c1 apply to base metal only
- (5) Controlling dimension: inches
- (6) Outline conform to JEDEC TO-262 except A1 (maximum), b (minimum) and D1 (minimum) where dimensions derived the actual package outline



Disclaimer

ALL PRODUCT, PRODUCT SPECIFICATIONS AND DATA ARE SUBJECT TO CHANGE WITHOUT NOTICE TO IMPROVE RELIABILITY, FUNCTION OR DESIGN OR OTHERWISE.

Vishay Intertechnology, Inc., its affiliates, agents, and employees, and all persons acting on its or their behalf (collectively, "Vishay"), disclaim any and all liability for any errors, inaccuracies or incompleteness contained in any datasheet or in any other disclosure relating to any product.

Vishay makes no warranty, representation or guarantee regarding the suitability of the products for any particular purpose or the continuing production of any product. To the maximum extent permitted by applicable law, Vishay disclaims (i) any and all liability arising out of the application or use of any product, (ii) any and all liability, including without limitation special, consequential or incidental damages, and (iii) any and all implied warranties, including warranties of fitness for particular purpose, non-infringement and merchantability.

Statements regarding the suitability of products for certain types of applications are based on Vishay's knowledge of typical requirements that are often placed on Vishay products in generic applications. Such statements are not binding statements about the suitability of products for a particular application. It is the customer's responsibility to validate that a particular product with the properties described in the product specification is suitable for use in a particular application. Parameters provided in datasheets and/or specifications may vary in different applications and performance may vary over time. All operating parameters, including typical parameters, must be validated for each customer application by the customer's technical experts. Product specifications do not expand or otherwise modify Vishay's terms and conditions of purchase, including but not limited to the warranty expressed therein.

Except as expressly indicated in writing, Vishay products are not designed for use in medical, life-saving, or life-sustaining applications or for any other application in which the failure of the Vishay product could result in personal injury or death. Customers using or selling Vishay products not expressly indicated for use in such applications do so at their own risk and agree to fully indemnify and hold Vishay and its distributors harmless from and against any and all claims, liabilities, expenses and damages arising or resulting in connection with such use or sale, including attorneys fees, even if such claim alleges that Vishay or its distributor was negligent regarding the design or manufacture of the part. Please contact authorized Vishay personnel to obtain written terms and conditions regarding products designed for such applications.

No license, express or implied, by estoppel or otherwise, to any intellectual property rights is granted by this document or by any conduct of Vishay. Product names and markings noted herein may be trademarks of their respective owners.