

## DO-203AB (DO-5) for 40HF(R) and 41HF(R) Series

**DIMENSIONS FOR 40HF(R) SERIES** in millimeters (inches)

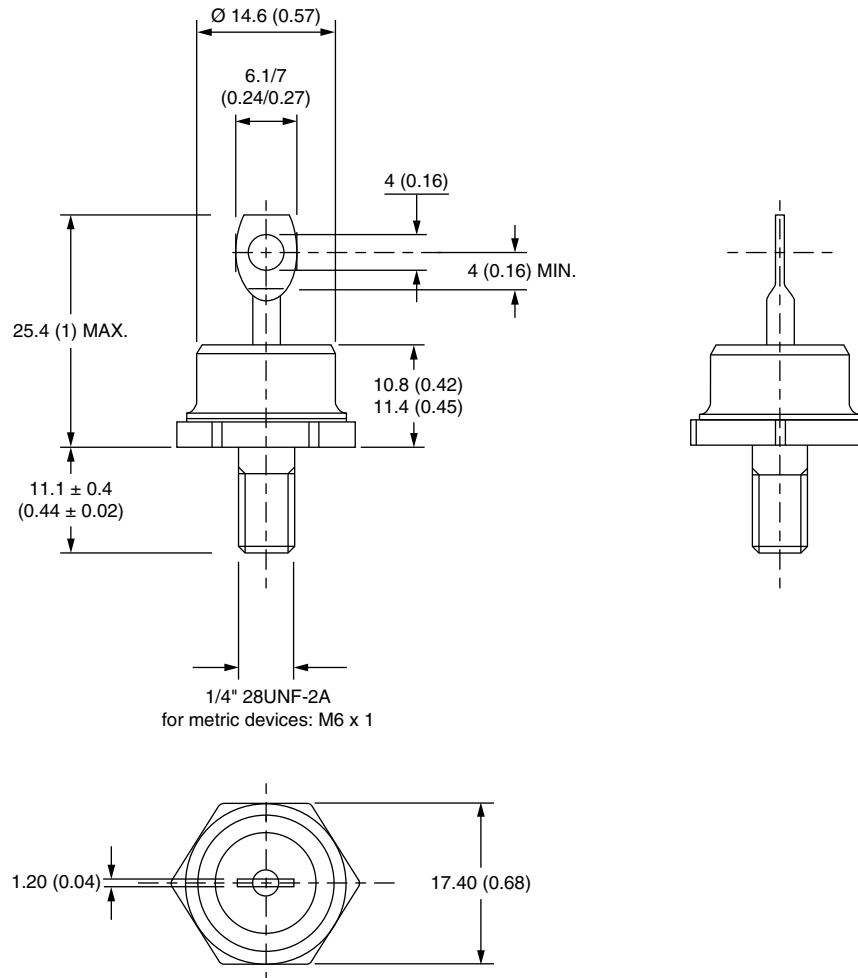

# Outline Dimensions

Vishay Semiconductors

DO-203AB (DO-5) for 40HF(R)  
and 41HF(R) Series



## DIMENSIONS FOR 41HF(R) SERIES in millimeters (inches)

