

Three Phase Bridge, 130 A to 160 A (Power Modules)

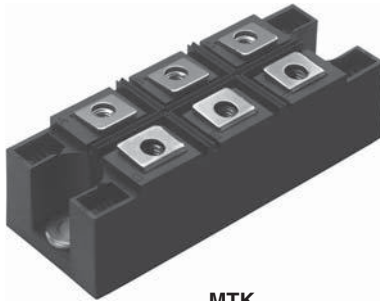

MTK

PRIMARY CHARACTERISTICS	
I_O	130 A to 160 A
V_{RRM}	800 V to 1600 V
Package	MTK
Circuit configuration	Three phase bridge

FEATURES

- Package fully compatible with the industry standard INT-A-PAK power modules series
- High thermal conductivity package, electrically insulated case
- Excellent power volume ratio
- 4000 V_{RMS} isolating voltage
- UL E78996 approved
- Designed and qualified for industrial level
- Material categorization: for definitions of compliance please see www.vishay.com/doc?99912

RoHS
COMPLIANT

DESCRIPTION

A range of extremely compact, encapsulated three phase bridge rectifiers offering efficient and reliable operation. They are intended for use in general purpose and heavy duty applications.

MAJOR RATINGS AND CHARACTERISTICS				
SYMBOL	CHARACTERISTICS	VALUES 130MT.K	VALUES 160MT.K	UNITS
I_O		130 (160)	160 (200)	A
	T_C	85 (62)	85 (60)	°C
I_{FSM}	50 Hz	1130	1430	A
	60 Hz	1180	1500	
I^2t	50 Hz	6400	10 200	A ² s
	60 Hz	5800	9300	
$I^2\sqrt{t}$		64 000	102 000	A ² √s
V_{RRM}	Range	800 to 1600		V
T_{Stg}	Range	-40 to 150		°C
T_J		-40 to 150		

ELECTRICAL SPECIFICATIONS

VOLTAGE RATINGS				
TYPE NUMBER	VOLTAGE CODE	V_{RRM} , MAXIMUM REPETITIVE PEAK REVERSE VOLTAGE V	V_{RSM} , MAXIMUM NON-REPETITIVE PEAK REVERSE VOLTAGE V	I_{RRM} MAXIMUM AT $T_J =$ MAXIMUM mA
VS-130MT.K VS-160MT.K	80	800	900	10
	100	1000	1100	
	120	1200	1300	
	140	1400	1500	
	160	1600	1700	



FORWARD CONDUCTION							
PARAMETER	SYMBOL	TEST CONDITIONS		VALUES 130MT.K	VALUES 160MT.K	UNITS	
Maximum DC output current at case temperature	I _O	120° rect. conduction angle		130 (160)	160 (200)	A	
				85 (62)	85 (60)	°C	
Maximum peak, one-cycle forward, non-repetitive surge current	I _{FSM}	t = 10 ms	No voltage reappplied	Initial T _J = T _J maximum	1130	1430	A
		t = 8.3 ms			1180	1500	
		t = 10 ms	100 % V _{RRM} reappplied		950	1200	
		t = 8.3 ms			1000	1260	
Maximum I ² t for fusing	I ² t	t = 10 ms	No voltage reappplied	Initial T _J = T _J maximum	6400	10 200	A ² s
		t = 8.3 ms			5800	9300	
		t = 10 ms	100 % V _{RRM} reappplied		4500	7200	
		t = 8.3 ms			4100	6600	
Maximum I ² √t for fusing	I ² √t	t = 0.1 ms to 10 ms, no voltage reappplied		64 000	102 000	A ² √s	
Low level value of threshold voltage	V _{T(TO)1}	(16.7 % × π × I _{T(AV)} < I < π × I _{T(AV)}), T _J maximum		0.78	0.81	V	
High level value of threshold voltage	V _{T(TO)2}	(I > π × I _{T(AV)}), T _J maximum		0.99	1.04		
Low level value of forward slope resistance	r _{F1}	16.7 % × π × I _{T(AV)} < I < π × I _{T(AV)} , T _J maximum		4.59	3.52	mΩ	
High level of forward slope resistance	r _{F2}	(I > π × I _{T(AV)}), T _J maximum		4.17	3.13		
Maximum forward voltage drop	V _{FM}	I _{pk} = 200 A, T _J = 25 °C, t _p = 400 μs single junction		1.63	1.49	V	
RMS isolation voltage	V _{ISOL}	T _J = 25 °C, all terminal shorted f = 50 Hz, t = 1 s		4000			

THERMAL AND MECHANICAL SPECIFICATIONS						
PARAMETER	SYMBOL	TEST CONDITIONS		VALUES 130MT.K	VALUES 160MT.K	UNITS
Maximum junction operating and storage temperature range	T _J , T _{Stg}			-40 to 150		°C
Maximum thermal resistance, junction to case	R _{thJC}	DC operation per module		0.16	0.12	K/W
		DC operation per junction		0.93	0.73	
		120° rect. conduction angle per module		0.18	0.15	
		120° rect. conduction angle per junction		1.08	0.88	
Maximum thermal resistance, case to heatsink	R _{thCS}	Per module Mounting surface smooth, flat and greased		0.03		
Mounting torque ± 10 %	to heatsink to terminal	A mounting compound is recommended and the torque should be rechecked after a period of 3 hours to allow for the spread of the compound. Lubricated threads.		4 to 6		Nm
				3 to 4		
Approximate weight				176		g

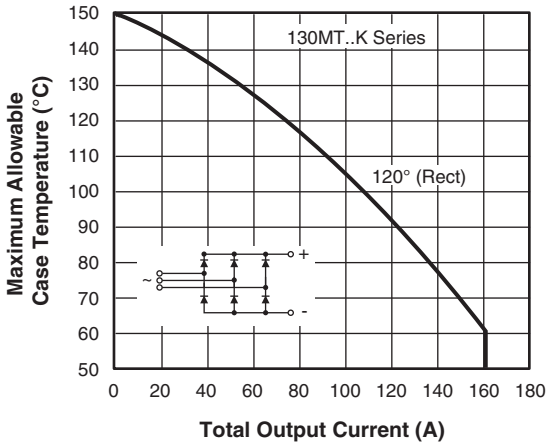

Fig. 1 - Current Rating Characteristics

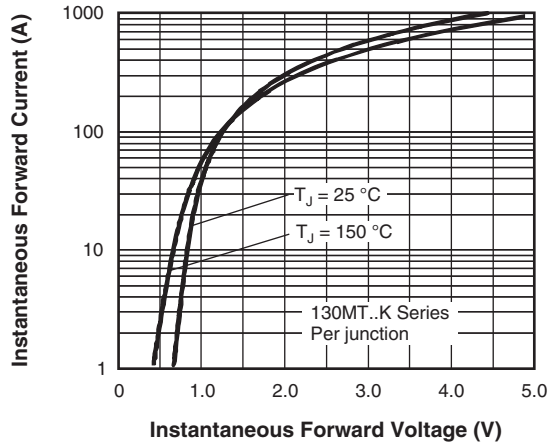

Fig. 2 - Forward Voltage Drop Characteristics

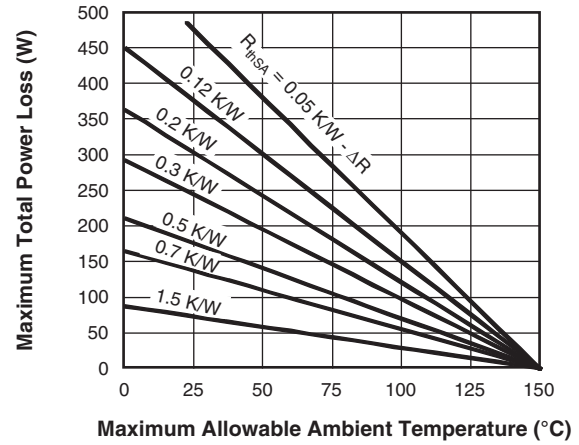
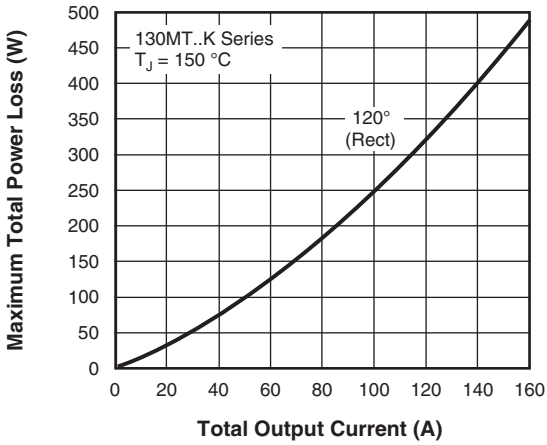

Fig. 3 - Total Power Loss Characteristics

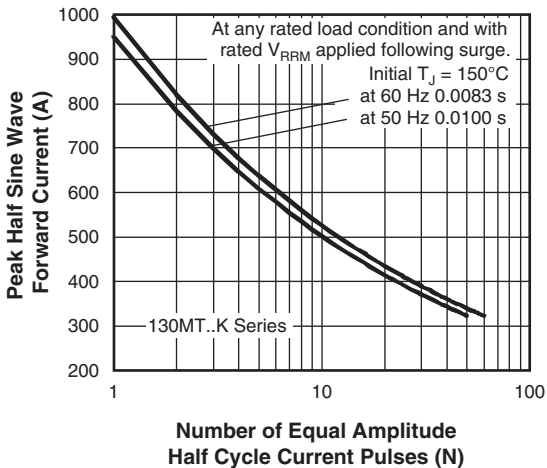

Fig. 4 - Maximum Non-Repetitive Surge Current

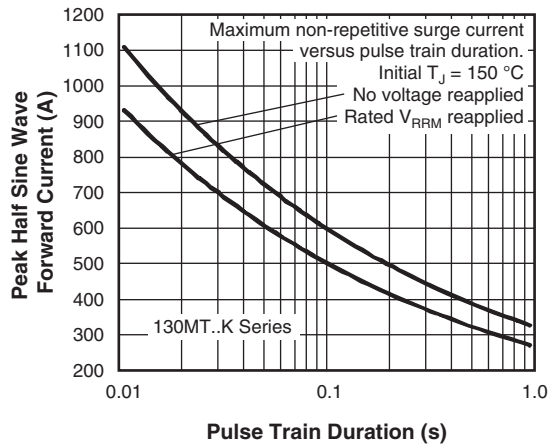

Fig. 5 - Maximum Non-Repetitive Surge Current

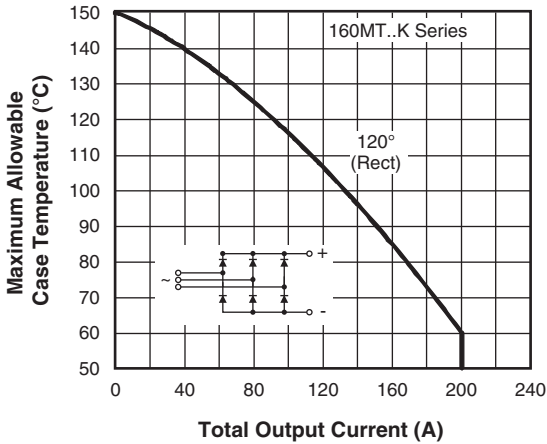

Fig. 6 - Current Ratings Characteristic

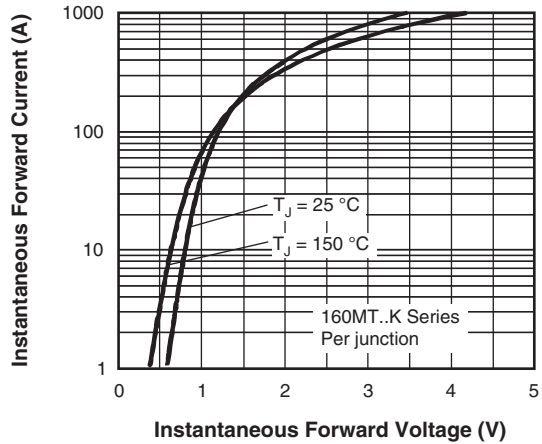

Fig. 7 - Forward Voltage Drop Characteristics

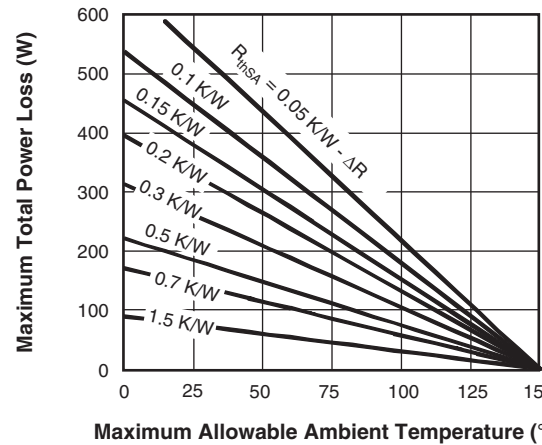
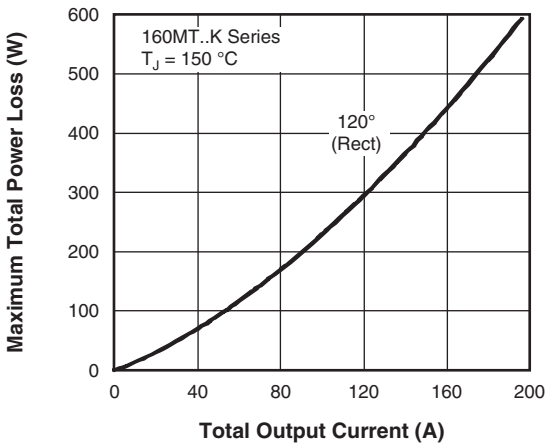

Fig. 8 - Total Power Loss Characteristics

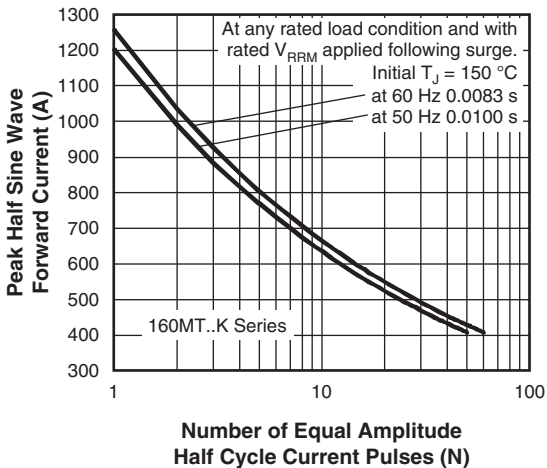

Fig. 9 - Maximum Non-Repetitive Surge Current

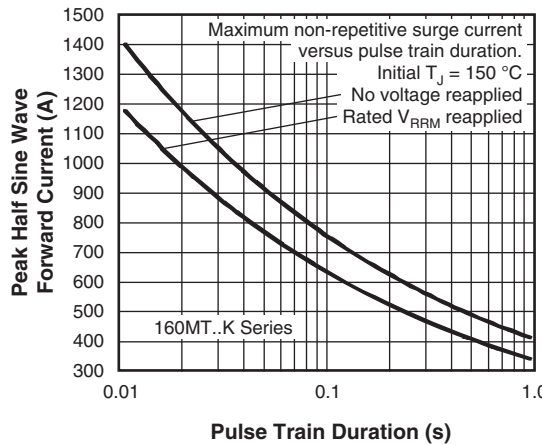

Fig. 10 - Maximum Non-Repetitive Surge Current

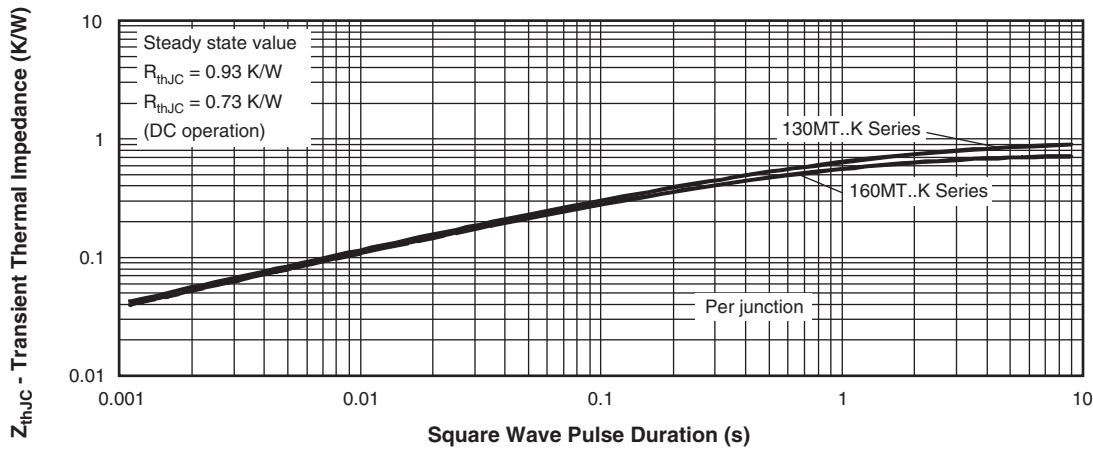

Fig. 11 - Thermal Impedance Z_{thJC} Characteristics

ORDERING INFORMATION TABLE

Device code	VS-	16	0	MT	160	K	PbF
	①	②	③	④	⑤		⑥
	1	2	3	4	5		6

- 1** - Vishay Semiconductors product
- 2** - Current rating code: 13 = 130 A (average)
16 = 160 A (average)
- 3** - Three phase diodes bridge
- 4** - Essential part number
- 5** - Voltage code x 10 = V_{RRM} (see Voltage Ratings table)
- 6** - PbF = Lead (Pb)-free

Note

- To order the optional hardware go to: www.vishay.com/doc?95172

CIRCUIT CONFIGURATION

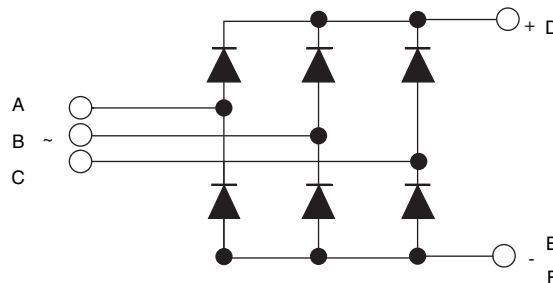

LINKS TO RELATED DOCUMENTS

Dimensions	www.vishay.com/doc?95004
------------	------------------------------------------------------------------------

MTK (with and without optional barrier)

DIMENSIONS WITH OPTIONAL BARRIERS in millimeters (inches)

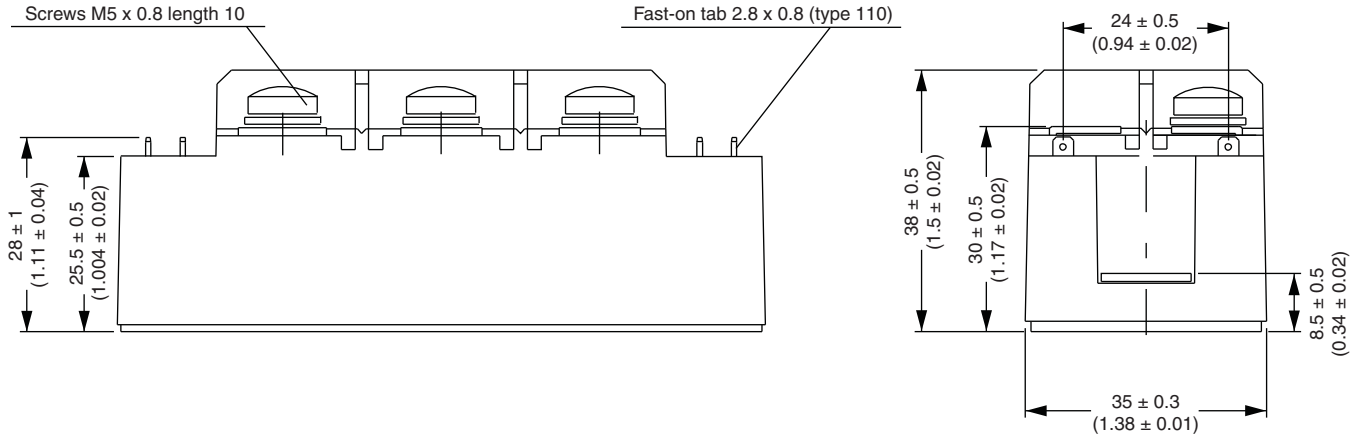

Outline Dimensions

Vishay Semiconductors MTK (with and without optional barrier)



DIMENSIONS WITHOUT OPTIONAL BARRIERS in millimeters (inches)





Disclaimer

ALL PRODUCT, PRODUCT SPECIFICATIONS AND DATA ARE SUBJECT TO CHANGE WITHOUT NOTICE TO IMPROVE RELIABILITY, FUNCTION OR DESIGN OR OTHERWISE.

Vishay Intertechnology, Inc., its affiliates, agents, and employees, and all persons acting on its or their behalf (collectively, "Vishay"), disclaim any and all liability for any errors, inaccuracies or incompleteness contained in any datasheet or in any other disclosure relating to any product.

Vishay makes no warranty, representation or guarantee regarding the suitability of the products for any particular purpose or the continuing production of any product. To the maximum extent permitted by applicable law, Vishay disclaims (i) any and all liability arising out of the application or use of any product, (ii) any and all liability, including without limitation special, consequential or incidental damages, and (iii) any and all implied warranties, including warranties of fitness for particular purpose, non-infringement and merchantability.

Statements regarding the suitability of products for certain types of applications are based on Vishay's knowledge of typical requirements that are often placed on Vishay products in generic applications. Such statements are not binding statements about the suitability of products for a particular application. It is the customer's responsibility to validate that a particular product with the properties described in the product specification is suitable for use in a particular application. Parameters provided in datasheets and / or specifications may vary in different applications and performance may vary over time. All operating parameters, including typical parameters, must be validated for each customer application by the customer's technical experts. Product specifications do not expand or otherwise modify Vishay's terms and conditions of purchase, including but not limited to the warranty expressed therein.

Hyperlinks included in this datasheet may direct users to third-party websites. These links are provided as a convenience and for informational purposes only. Inclusion of these hyperlinks does not constitute an endorsement or an approval by Vishay of any of the products, services or opinions of the corporation, organization or individual associated with the third-party website. Vishay disclaims any and all liability and bears no responsibility for the accuracy, legality or content of the third-party website or for that of subsequent links.

Except as expressly indicated in writing, Vishay products are not designed for use in medical, life-saving, or life-sustaining applications or for any other application in which the failure of the Vishay product could result in personal injury or death. Customers using or selling Vishay products not expressly indicated for use in such applications do so at their own risk. Please contact authorized Vishay personnel to obtain written terms and conditions regarding products designed for such applications.

No license, express or implied, by estoppel or otherwise, to any intellectual property rights is granted by this document or by any conduct of Vishay. Product names and markings noted herein may be trademarks of their respective owners.