

Thyristor High Voltage, Phase Control SCR, 10 A

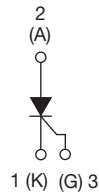

TO-220AB 3L



FEATURES

- Designed and qualified according to JEDEC®-JESD 47
- 125 °C max. operating junction temperature
- Material categorization: for definitions of compliance please see www.vishay.com/doc?99912

RoHS
 COMPLIANT
 HALOGEN
FREE

APPLICATIONS

- Typical usage is in input rectification crowbar (soft star) and AC switch in motor control, UPS, welding, and battery charge

DESCRIPTION

The VS-10TTS08... high voltage series of silicon controlled rectifiers are specifically designed for medium power switching and phase control applications. The glass passivation technology used has reliable operation up to 125 °C junction temperature.

PRIMARY CHARACTERISTICS	
$I_{T(AV)}$	6.5 A
V_{DRM}/V_{RRM}	800 V
V_{TM}	1.15 V
I_{GT}	15 mA
T_J	-40 °C to 125 °C
Package	TO-220AB 3L
Circuit configuration	Single SCR

OUTPUT CURRENT IN TYPICAL APPLICATIONS			
APPLICATIONS	SINGLE-PHASE BRIDGE	THREE-PHASE BRIDGE	UNITS
Capacitive input filter $T_A = 55\text{ °C}$, $T_J = 125\text{ °C}$, common heatsink of 1 °C/W	13.5	17	A

MAJOR RATINGS AND CHARACTERISTICS			
PARAMETER	TEST CONDITIONS	VALUES	UNITS
$I_{T(AV)}$	Sinusoidal waveform	6.5	A
$I_{T(RMS)}$		10	
V_{RRM}/V_{DRM}		800	V
I_{TSM}		110	A
V_T	6.5 A, $T_J = 25\text{ °C}$	1.15	V
dV/dt		150	V/μs
dI/dt		100	A/μs
T_J	Range	-40 to +125	°C

VOLTAGE RATINGS			
PART NUMBER	V_{RRM} , MAXIMUM PEAK REVERSE VOLTAGE V	V_{DRM} , MAXIMUM PEAK DIRECT VOLTAGE V	I_{RRM}/I_{DRM} AT 125 °C mA
VS-10TTS08-M3	800	800	1.0



ABSOLUTE MAXIMUM RATINGS					
PARAMETER	SYMBOL	TEST CONDITIONS		VALUES	UNITS
Maximum average on-state current	$I_{T(AV)}$	$T_C = 112\text{ }^\circ\text{C}$, 180° conduction half sine wave		6.5	A
Maximum RMS on-state current	$I_{T(RMS)}$			10	
Maximum peak, one-cycle, non-repetitive surge current	I_{TSM}	10 ms sine pulse, rated V_{RRM} applied, $T_J = 125\text{ }^\circ\text{C}$		95	
		10 ms sine pulse, no voltage reapplied, $T_J = 125\text{ }^\circ\text{C}$		110	
Maximum I^2t for fusing	I^2t	10 ms sine pulse, rated V_{RRM} applied, $T_J = 125\text{ }^\circ\text{C}$		45	A^2s
		10 ms sine pulse, no voltage reapplied, $T_J = 125\text{ }^\circ\text{C}$		64	
Maximum $I^2\sqrt{t}$ for fusing	$I^2\sqrt{t}$	$t = 0.1\text{ ms to } 10\text{ ms}$, no voltage reapplied, $T_J = 125\text{ }^\circ\text{C}$		640	$A^2\sqrt{s}$
Maximum on-state voltage drop	V_{TM}	6.5 A, $T_J = 25\text{ }^\circ\text{C}$		1.15	V
On-state slope resistance	r_t	$T_J = 125\text{ }^\circ\text{C}$		17.3	$m\Omega$
Threshold voltage	$V_{T(TO)}$			0.85	V
Maximum reverse and direct leakage current	I_{RM}/I_{DM}	$T_J = 25\text{ }^\circ\text{C}$	$V_R = \text{Rated } V_{RRM}/V_{DRM}$	0.05	mA
		$T_J = 125\text{ }^\circ\text{C}$		1.0	
Typical holding current	I_H	Anode supply = 6 V, resistive load, initial $I_T = 1\text{ A}$, $T_J = 25\text{ }^\circ\text{C}$		30	
Maximum latching current	I_L	Anode supply = 6 V, resistive load, $T_J = 25\text{ }^\circ\text{C}$		50	
Maximum rate of rise of off-state voltage	dV/dt	$T_J = T_J \text{ max.}$, linear to 80 %, $V_{DRM} = R_g - k = \text{Open}$		150	$V/\mu s$
Maximum rate of rise of turned-on current	dI/dt			100	$A/\mu s$

TRIGGERING					
PARAMETER	SYMBOL	TEST CONDITIONS		VALUES	UNITS
Maximum peak gate power	P_{GM}			8.0	W
Maximum average gate power	$P_{G(AV)}$			2.0	
Maximum peak positive gate current	$+I_{GM}$			1.5	A
Maximum peak negative gate voltage	$-V_{GM}$			10	V
Maximum required DC gate current to trigger	I_{GT}	Anode supply = 6 V, resistive load, $T_J = -65\text{ }^\circ\text{C}$		20	mA
		Anode supply = 6 V, resistive load, $T_J = 25\text{ }^\circ\text{C}$		15	
		Anode supply = 6 V, resistive load, $T_J = 125\text{ }^\circ\text{C}$		10	
Maximum required DC gate voltage to trigger	V_{GT}	Anode supply = 6 V, resistive load, $T_J = -65\text{ }^\circ\text{C}$		1.2	V
		Anode supply = 6 V, resistive load, $T_J = 25\text{ }^\circ\text{C}$		1	
		Anode supply = 6 V, resistive load, $T_J = 125\text{ }^\circ\text{C}$		0.7	
Maximum DC gate voltage not to trigger	V_{GD}	$T_J = 125\text{ }^\circ\text{C}$, $V_{DRM} = \text{Rated value}$		0.2	mA
Maximum DC gate current not to trigger	I_{GD}			0.1	

SWITCHING					
PARAMETER	SYMBOL	TEST CONDITIONS		VALUES	UNITS
Typical turn-on time	t_{gt}	$T_J = 25\text{ }^\circ\text{C}$		0.8	μs
Typical reverse recovery time	t_{rr}	$T_J = 125\text{ }^\circ\text{C}$		3	
Typical turn-off time	t_q			100	



THERMAL AND MECHANICAL SPECIFICATIONS				
PARAMETER	SYMBOL	TEST CONDITIONS	VALUES	UNITS
Maximum junction and storage temperature range	T_J, T_{Stg}		-40 to +125	°C
Maximum thermal resistance, junction to case	R_{thJC}	DC operation	1.5	°C/W
Maximum thermal resistance, junction to ambient	R_{thJA}		62	
Typical thermal resistance, case to heatsink	R_{thCS}	Mounting surface, smooth and greased	0.5	
Approximate weight			2	g
			0.07	oz.
Mounting torque	minimum		6 (5)	kgf · cm (lbf · in)
	maximum		12 (10)	
Marking device		Case style TO-220AB 3L	10TTS08	

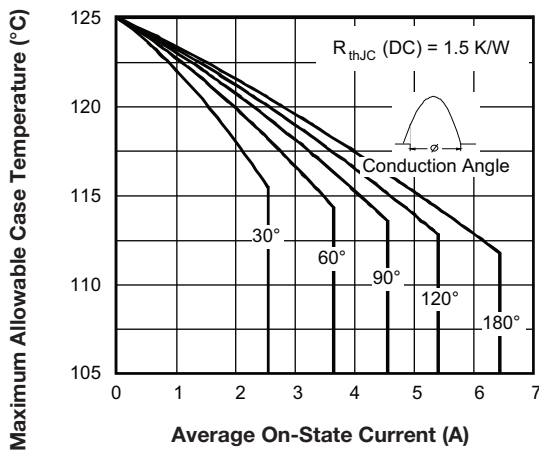

Fig. 1 - Current Rating Characteristics

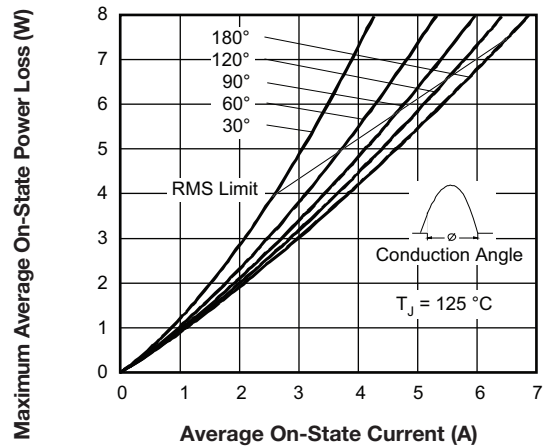

Fig. 3 - On-State Power Loss Characteristics

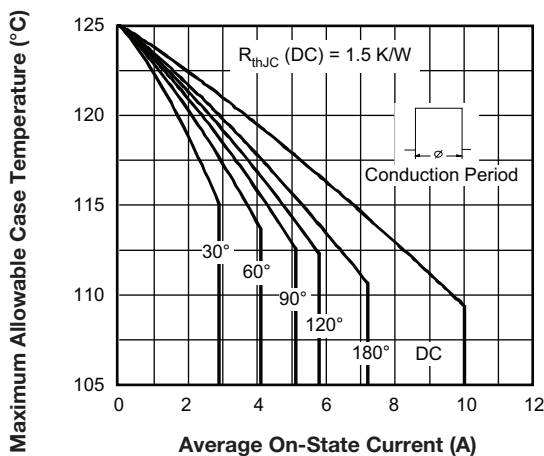

Fig. 2 - Current Rating Characteristic

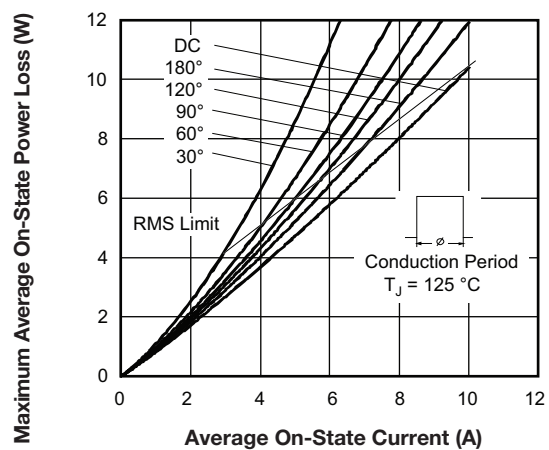

Fig. 4 - On-State Power Loss Characteristics

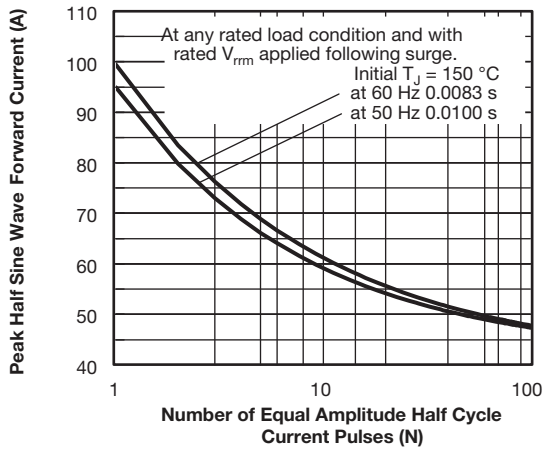

Fig. 5 - Maximum Non-Repetitive Surge Current

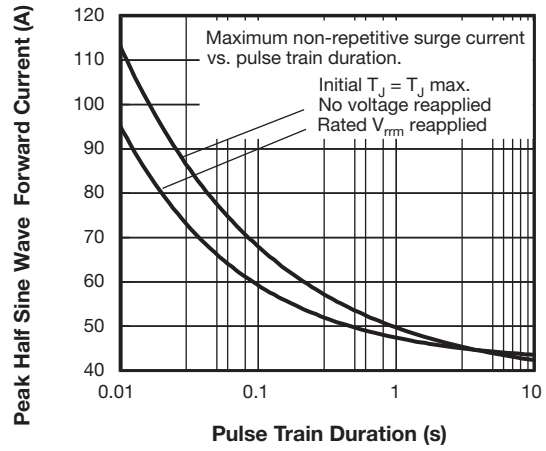

Fig. 6 - Maximum Non-Repetitive Surge Current

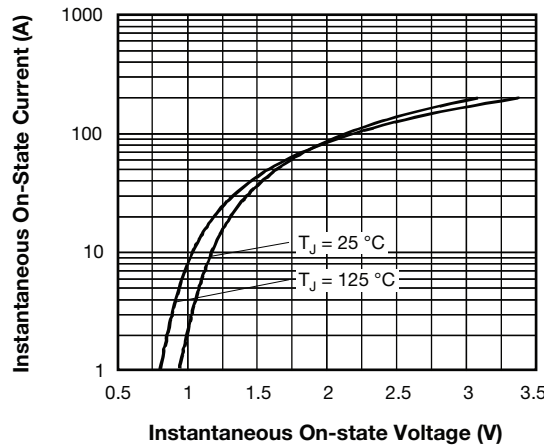

Fig. 7 - On-State Voltage Drop Characteristics

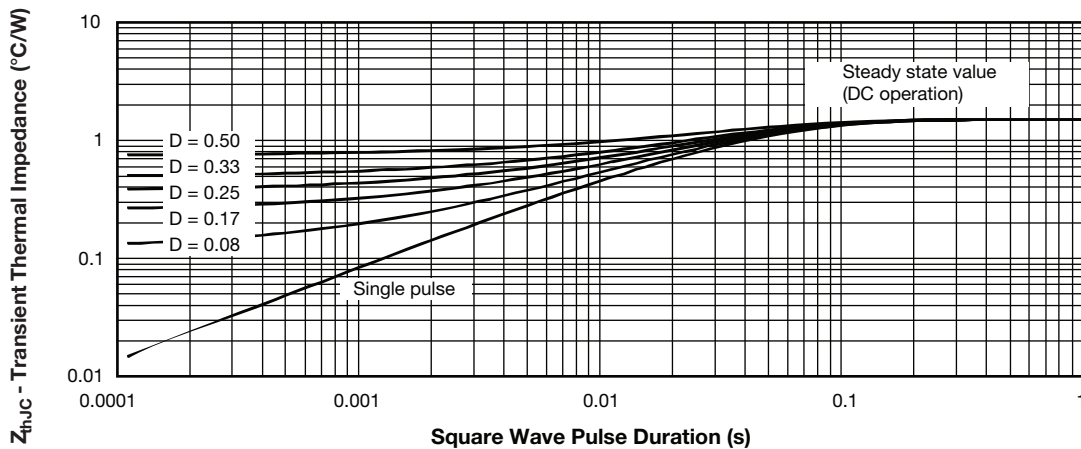
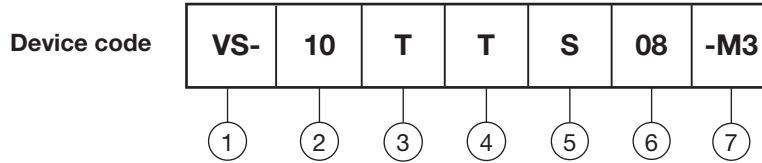

Fig. 8 - Thermal Impedance Z_{thJC} Characteristics



ORDERING INFORMATION TABLE



- 1** - Vishay Semiconductors product
- 2** - Current rating
- 3** - Circuit configuration:
T = single thyristor
- 4** - Package:
T = TO-220AB
- 5** - Type of silicon:
S = converter grade
- 6** - Voltage code x 100 = V_{RRM}
- 7** - Environmental digit:
-M3 = halogen-free, RoHS-compliant, and terminations lead (Pb)-free

ORDERING INFORMATION (Example)		
PREFERRED P/N	BASE QUANTITY	PACKAGING DESCRIPTION
VS-10TTS08-M3	50	Antistatic plastic tubes

LINKS TO RELATED DOCUMENTS	
Dimensions	www.vishay.com/doc?96154
Part marking information	www.vishay.com/doc?95028



TO-220AB 3L

DIMENSIONS in millimeters and inches

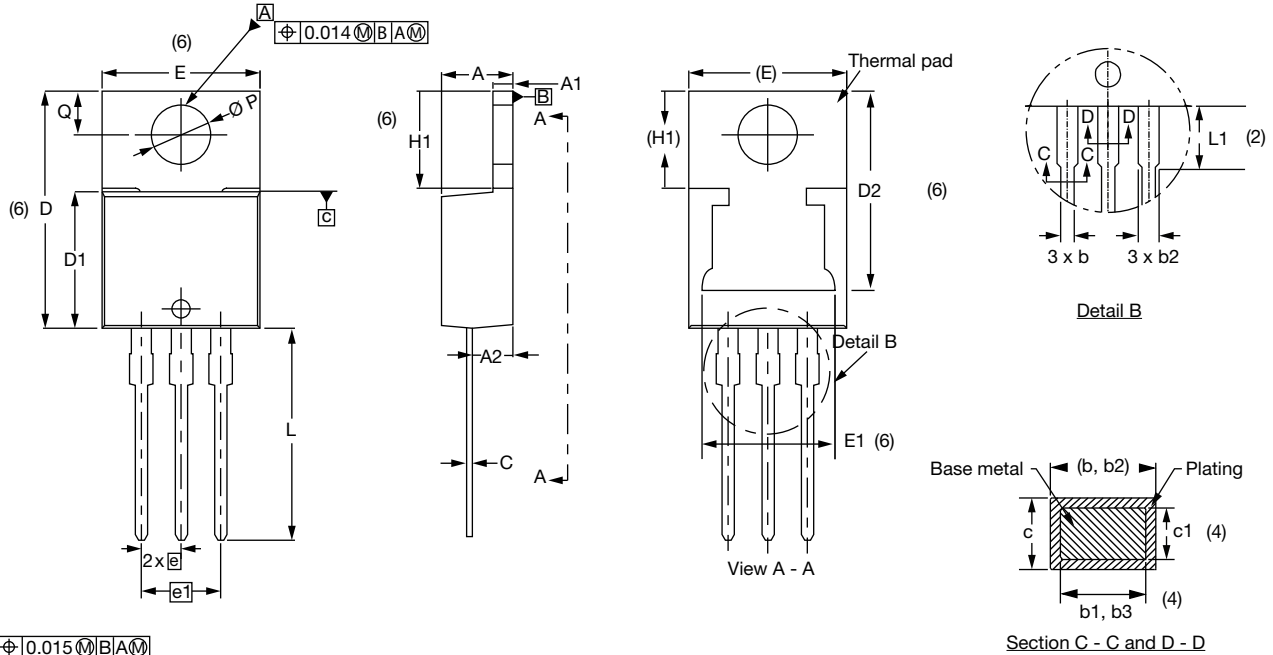

Conforms to JEDEC® outline TO-220AB

SYMBOL	MILLIMETERS		INCHES		NOTES	SYMBOL	MILLIMETERS		INCHES		NOTES
	MIN.	MAX.	MIN.	MAX.			MIN.	MAX.	MIN.	MAX.	
A	4.25	4.65	0.167	0.183		D2	11.68	13.30	0.460	0.524	6, 7
A1	1.14	1.40	0.045	0.055		E	10.11	10.51	0.398	0.414	3, 6
A2	2.50	2.92	0.098	0.115		E1	6.86	8.89	0.270	0.350	6
b	0.69	1.01	0.027	0.040		e	2.41	2.67	0.095	0.105	
b1	0.38	0.97	0.015	0.038	4	e1	4.88	5.28	0.192	0.208	
b2	1.20	1.73	0.047	0.068		H1	6.09	6.48	0.240	0.255	6
b3	1.14	1.73	0.045	0.068	4	L	13.52	14.02	0.532	0.552	
c	0.36	0.61	0.014	0.024		L1	3.32	3.82	0.131	0.150	2
c1	0.36	0.56	0.014	0.022	4	Ø P	3.54	3.91	0.139	0.154	
D	14.85	15.35	0.585	0.604	3	Q	2.60	3.00	0.102	0.118	
D1	8.38	9.02	0.330	0.355							

Notes

- (1) Dimensioning and tolerancing as per ASME Y14.5M-1994
- (2) Lead dimension and finish uncontrolled in L1
- (3) Dimension D, D1, and E do not include mold flash. Mold flash shall not exceed 0.127 mm (0.005") per side. These dimensions are measured at the outermost extremes of the plastic body
- (4) Dimension b1, b3, and c1 apply to base metal only
- (5) Controlling dimensions: inches
- (6) Thermal pad contour optional within dimensions E, H1, D2, and E1
- (7) Outline conforms to JEDEC® TO-220, except D2



Disclaimer

ALL PRODUCT, PRODUCT SPECIFICATIONS AND DATA ARE SUBJECT TO CHANGE WITHOUT NOTICE TO IMPROVE RELIABILITY, FUNCTION OR DESIGN OR OTHERWISE.

Vishay Intertechnology, Inc., its affiliates, agents, and employees, and all persons acting on its or their behalf (collectively, "Vishay"), disclaim any and all liability for any errors, inaccuracies or incompleteness contained in any datasheet or in any other disclosure relating to any product.

Vishay makes no warranty, representation or guarantee regarding the suitability of the products for any particular purpose or the continuing production of any product. To the maximum extent permitted by applicable law, Vishay disclaims (i) any and all liability arising out of the application or use of any product, (ii) any and all liability, including without limitation special, consequential or incidental damages, and (iii) any and all implied warranties, including warranties of fitness for particular purpose, non-infringement and merchantability.

Statements regarding the suitability of products for certain types of applications are based on Vishay's knowledge of typical requirements that are often placed on Vishay products in generic applications. Such statements are not binding statements about the suitability of products for a particular application. It is the customer's responsibility to validate that a particular product with the properties described in the product specification is suitable for use in a particular application. Parameters provided in datasheets and / or specifications may vary in different applications and performance may vary over time. All operating parameters, including typical parameters, must be validated for each customer application by the customer's technical experts. Product specifications do not expand or otherwise modify Vishay's terms and conditions of purchase, including but not limited to the warranty expressed therein.

Hyperlinks included in this datasheet may direct users to third-party websites. These links are provided as a convenience and for informational purposes only. Inclusion of these hyperlinks does not constitute an endorsement or an approval by Vishay of any of the products, services or opinions of the corporation, organization or individual associated with the third-party website. Vishay disclaims any and all liability and bears no responsibility for the accuracy, legality or content of the third-party website or for that of subsequent links.

Except as expressly indicated in writing, Vishay products are not designed for use in medical, life-saving, or life-sustaining applications or for any other application in which the failure of the Vishay product could result in personal injury or death. Customers using or selling Vishay products not expressly indicated for use in such applications do so at their own risk. Please contact authorized Vishay personnel to obtain written terms and conditions regarding products designed for such applications.

No license, express or implied, by estoppel or otherwise, to any intellectual property rights is granted by this document or by any conduct of Vishay. Product names and markings noted herein may be trademarks of their respective owners.