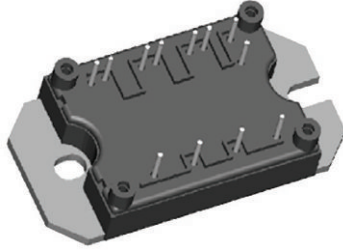

“Half Bridge” MTP Trench IGBT, 75 A

MTP

FEATURES

- Trench gate field stop technology
- Positive $V_{CE(on)}$ temperature coefficient
- 5 μ s short circuit capability
- Square RBSOA
- HEXFRED® antiparallel diodes with ultrasoft reverse recovery and low V_F
- Al_2O_3 DBC
- Very low stray inductance design for high speed operation
- UL approved file E78996
- Designed and qualified for industrial level
- Material categorization: for definitions of compliance please see www.vishay.com/doc?99912

RoHS*
Available

Note

* This datasheet provides information about parts that are RoHS-compliant and / or parts that are non RoHS-compliant. For example, parts with lead (Pb) terminations are not RoHS-compliant. Please see the information / tables in this datasheet for details

PRIMARY CHARACTERISTICS

V_{CES}	1200 V
$V_{CE(on)}$ typical at $I_C = 40$ A	2.24 V
I_C at $T_C = 25$ °C	75 A
Speed	8 kHz to 30 kHz
Package	MTP
Circuit configuration	Half bridge

BENEFITS

- Optimized for welding, UPS and SMPS applications
- Rugged with ultrafast performance
- Benchmark efficiency above 20 kHz
- Outstanding ZVS and hard switching operation
- Low EMI, requires less snubbing
- Excellent current sharing in parallel operation
- Direct mounting to heatsink
- PCB solderable terminals
- Very low junction to case thermal resistance

ABSOLUTE MAXIMUM RATINGS

PARAMETER	SYMBOL	TEST CONDITIONS	MAX.	UNITS
Collector to emitter breakdown voltage	V_{CES}		1200	V
Continuous collector current	I_C	$T_C = 25$ °C	75	A
		$T_C = 102$ °C	40	
Pulsed collector current	I_{CM}	$T_J = 150$ °C, $t_p = 6$ ms, $V_{GE} = 15$ V	150	
Clamped inductive load current	I_{LM}		120	
Diode continuous forward current	I_F	$T_C = 105$ °C	21	
Diode maximum forward current	I_{FM}		160	
Gate to emitter voltage	V_{GE}		± 20	V
RMS isolation voltage	V_{ISOL}	Any terminal to case, $t = 1$ min	2500	
Maximum power dissipation (only IGBT)	P_D	$T_C = 25$ °C	305	W
		$T_C = 100$ °C	122	



ELECTRICAL SPECIFICATIONS ($T_J = 25\text{ }^\circ\text{C}$ unless otherwise specified)						
PARAMETER	SYMBOL	TEST CONDITIONS	MIN.	TYP.	MAX.	UNITS
Collector to emitter breakdown voltage	$V_{(BR)CES}$	$V_{GE} = 0\text{ V}, I_C = 2\text{ mA}$	1200	-	-	V
Collector to emitter saturation voltage	$V_{CE(on)}$	$V_{GE} = 15\text{ V}, I_C = 40\text{ A}$	-	2.24	2.65	V
		$V_{GE} = 15\text{ V}, I_C = 80\text{ A}$	-	2.84	-	
		$V_{GE} = 15\text{ V}, I_C = 40\text{ A}, T_J = 150\text{ }^\circ\text{C}$	-	2.53	-	
		$V_{GE} = 15\text{ V}, I_C = 80\text{ A}, T_J = 150\text{ }^\circ\text{C}$	-	3.44	-	
Gate threshold voltage	$V_{GE(th)}$	$V_{CE} = V_{GE}, I_C = 2\text{ mA}$	4.6	5.9	7.6	
Temperature coefficient of threshold voltage	$V_{GE(th)}/\Delta T_J$	$V_{CE} = V_{GE}, I_C = 2\text{ mA}$ ($25\text{ }^\circ\text{C}$ to $125\text{ }^\circ\text{C}$)	-	-13	-	mV/ $^\circ\text{C}$
Transconductance	g_{fe}	$V_{CE} = 50\text{ V}, I_C = 40\text{ A}$	-	29	-	S
Zero gate voltage collector current	I_{CES}	$V_{GE} = 0\text{ V}, V_{CE} = 1200\text{ V}, T_J = 25\text{ }^\circ\text{C}$	-	0.6	50	μA
		$V_{GE} = 0\text{ V}, V_{CE} = 1200\text{ V}, T_J = 125\text{ }^\circ\text{C}$	-	0.31	-	mA
		$V_{GE} = 0\text{ V}, V_{CE} = 1200\text{ V}, T_J = 150\text{ }^\circ\text{C}$	-	1.16	-	
Gate to emitter leakage current	I_{GES}	$V_{GE} = \pm 20\text{ V}$	-	-	± 250	nA

SWITCHING CHARACTERISTICS ($T_J = 25\text{ }^\circ\text{C}$ unless otherwise specified)						
PARAMETER	SYMBOL	TEST CONDITIONS	MIN.	TYP.	MAX.	UNITS
Total gate charge (turn-on)	Q_g	$I_C = 40\text{ A}$ $V_{CC} = 960\text{ V}$ $V_{GE} = 15\text{ V}$	-	158	-	nC
Gate to emitter charge (turn-on)	Q_{ge}		-	17	-	
Gate to collector charge (turn-on)	Q_{gc}		-	85	-	
Turn-on switching loss	E_{on}	$V_{CC} = 600\text{ V}, I_C = 40\text{ A}, V_{GE} = 15\text{ V},$ $R_g = 5\text{ }\Omega, L = 200\text{ }\mu\text{H}, T_J = 25\text{ }^\circ\text{C},$ energy losses include tail and diode reverse recovery	-	0.76	-	mJ
Turn-off switching loss	E_{off}		-	1.14	-	
Total switching loss	E_{tot}		-	1.9	-	
Turn-on switching loss	E_{on}		-	1.02	-	
Turn-off switching loss	E_{off}		-	1.83	-	
Total switching loss	E_{tot}	-	2.85	-		
Input capacitance	C_{ies}	$V_{GE} = 0\text{ V}$ $V_{CC} = 25\text{ V}$ $f = 1.0\text{ MHz}$	-	3200	-	pF
Output capacitance	C_{oes}		-	220	-	
Reverse transfer capacitance	C_{res}		-	80	-	
Reverse bias safe operating area	RBSOA	$T_J = 150\text{ }^\circ\text{C}, I_C = 120\text{ A}$ $V_{CC} = 800\text{ V}, V_p = 1200\text{ V}$ $R_g = 10\text{ }\Omega, V_{GE} = +15\text{ V to } 0\text{ V}$	Fullsquare			
Short circuit safe operating area	SCSOA	$T_J = 150\text{ }^\circ\text{C},$ $V_{CC} = 600\text{ V}, V_p = 1200\text{ V}$ $V_{GE} = +15\text{ V to } 0\text{ V}$	5	-	-	μs

DIODE SPECIFICATIONS ($T_J = 25\text{ }^\circ\text{C}$ unless otherwise specified)						
PARAMETER	SYMBOL	TEST CONDITIONS	MIN.	TYP.	MAX.	UNITS
Diode forward voltage drop	V_{FM}	$I_C = 40\text{ A}$	-	2.98	3.38	V
		$I_C = 80\text{ A}$	-	3.90	-	
		$I_C = 40\text{ A}, T_J = 125\text{ }^\circ\text{C}$	-	3.08	-	
		$I_C = 80\text{ A}, T_J = 125\text{ }^\circ\text{C}$	-	4.29	-	
		$I_C = 40\text{ A}, T_J = 150\text{ }^\circ\text{C}$	-	3.12	-	
Reverse recovery energy of the diode	E_{rec}	$V_{GE} = 15\text{ V}, R_g = 5\text{ }\Omega, L = 200\text{ }\mu\text{H}$ $V_{CC} = 600\text{ V}, I_C = 40\text{ A}$ $T_J = 125\text{ }^\circ\text{C}$	-	574	-	μJ
Diode reverse recovery time	t_{rr}		-	120	-	ns
Peak reverse recovery current	I_{rr}		-	43	-	A



THERMAL AND MECHANICAL SPECIFICATIONS						
PARAMETER	SYMBOL	TEST CONDITIONS	MIN.	TYP.	MAX.	UNITS
Junction and storage temperature range	T_J, T_{Stg}		-40	-	150	°C
Junction to case	IGBT	R_{thJC}	-	-	0.41	°C/W
	Diode		-	-	0.61	
Case to sink per module	R_{thCS}		-	0.06	-	
Clearance ⁽¹⁾		External shortest distance in air between 2 terminals	5.5	-	-	mm
Creepage ⁽²⁾		Shortest distance along external surface of the insulating material between 2 terminals	8	-	-	
Mounting torque to heatsink		A mounting compound is recommended and the torque should be checked after 3 hours to allow for the spread of the compound. Lubricated threads.	3 ± 10 %			Nm
Weight			66			g

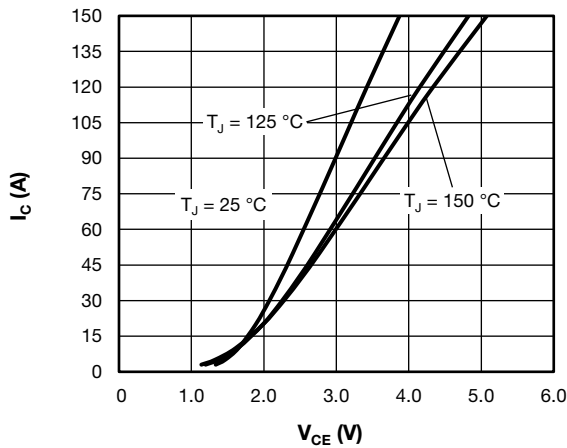

Fig. 1 - Typical Trench IGBT Output Characteristics, $V_{GE} = 15\text{ V}$

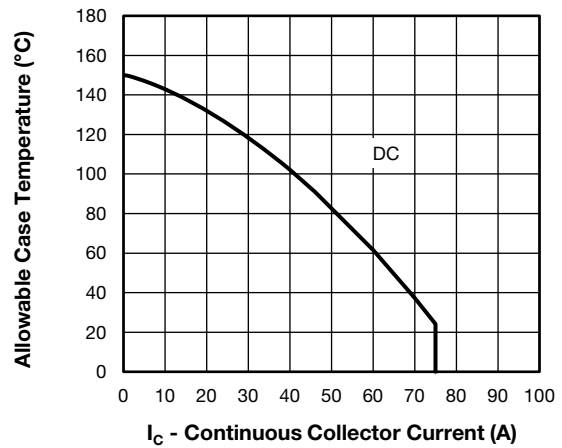

Fig. 3 - Maximum Trench IGBT Continuous Collector Current vs. Case Temperature

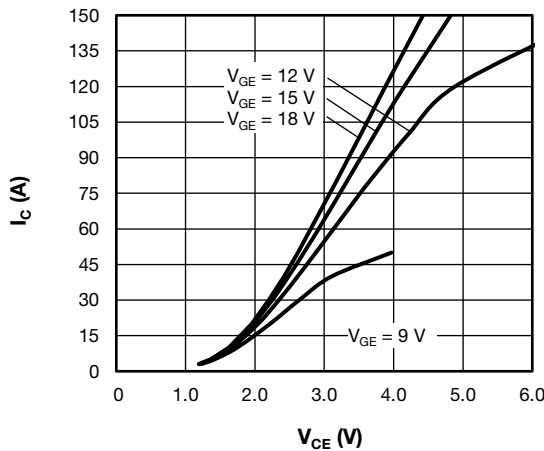

Fig. 2 - Typical Trench IGBT Output Characteristics, $T_J = 125\text{ °C}$

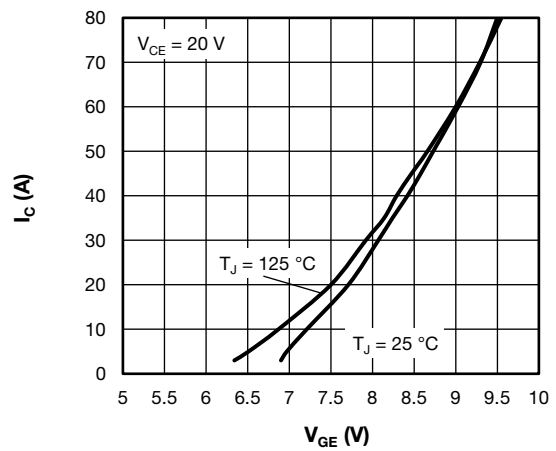

Fig. 4 - Typical Trench IGBT Transfer Characteristics

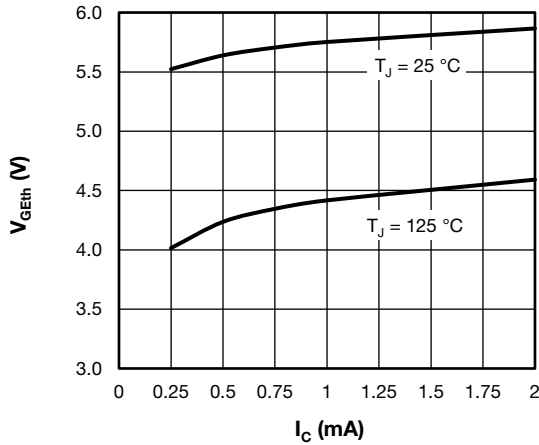

Fig. 5 - Typical Trench IGBT Gate Threshold Voltage

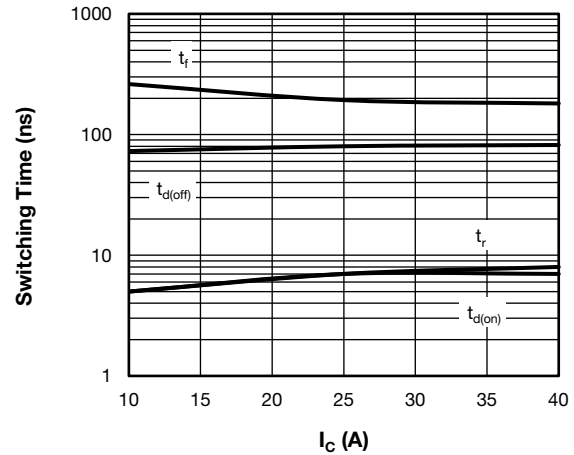

Fig. 8 - Typical Trench IGBT Switching Time vs. I_C (with Antiparallel Diode)

$T_J = 125\text{ }^\circ\text{C}$, $V_{CC} = 600\text{ V}$, $R_g = 4.7\ \Omega$, $V_{GE} = +15\text{V}/-15\text{V}$, $L = 500\ \mu\text{H}$

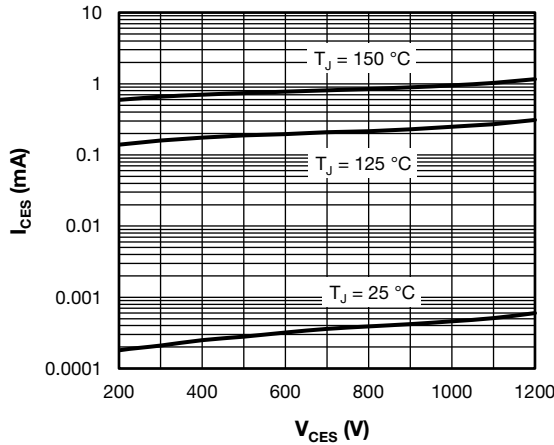

Fig. 6 - Typical Trench IGBT Zero Gate Voltage Collector Current

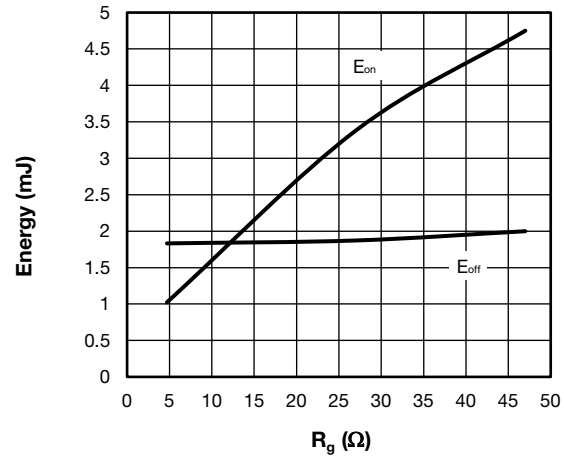

Fig. 9 - Typical Trench IGBT Energy Loss vs. R_g (with Antiparallel Diode)

$T_J = 125\text{ }^\circ\text{C}$, $V_{CC} = 600\text{ V}$, $I_C = 40\text{ A}$, $V_{GE} = +15\text{V}/-15\text{V}$, $L = 500\ \mu\text{H}$

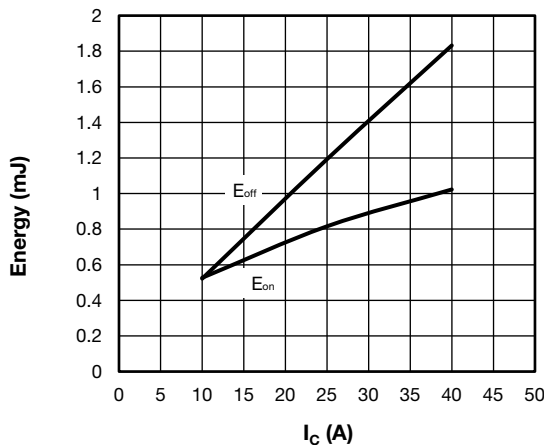

Fig. 7 - Typical Trench IGBT Energy Loss vs. I_C (with Antiparallel Diode)

$T_J = 125\text{ }^\circ\text{C}$, $V_{CC} = 600\text{ V}$, $R_g = 4.7\ \Omega$, $V_{GE} = +15\text{V}/-15\text{V}$, $L = 500\ \mu\text{H}$

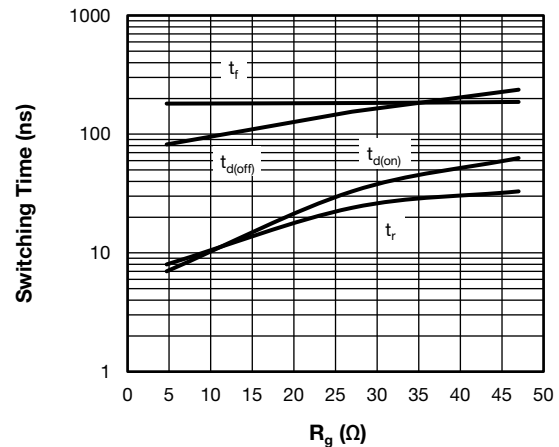

Fig. 10 - Typical Trench IGBT Switching Time vs. R_g (with Antiparallel Diode)

$T_J = 125\text{ }^\circ\text{C}$, $V_{CC} = 600\text{ V}$, $I_C = 40\text{ A}$, $V_{GE} = +15\text{V}/-15\text{V}$, $L = 500\ \mu\text{H}$

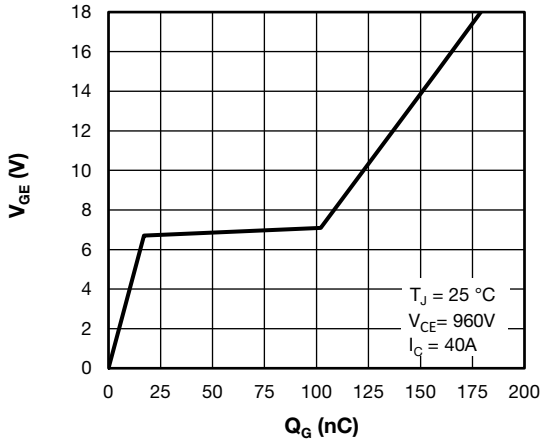

Fig. 11 - Typical Trench IGBT Gate Charge vs. Gate to Emitter Voltage

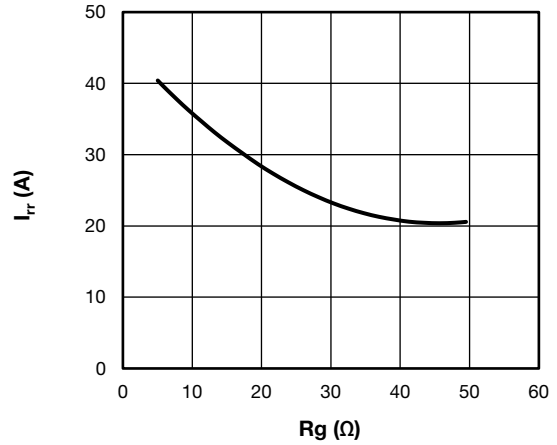

Fig. 14 - Typical Diode I_{rr} vs. R_g
 $T_J = 125\text{ }^\circ\text{C}$; $I_F = 40\text{ A}$

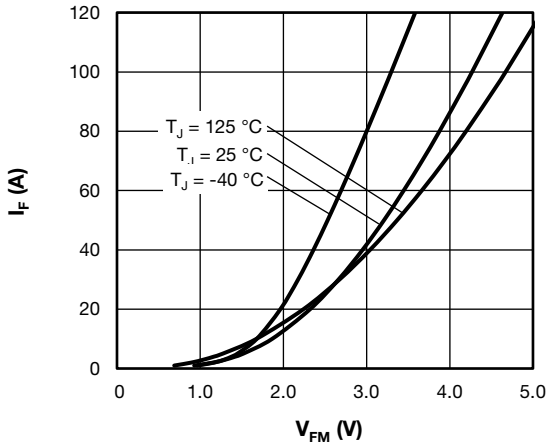

Fig. 12 - Typical Diode Forward Characteristics

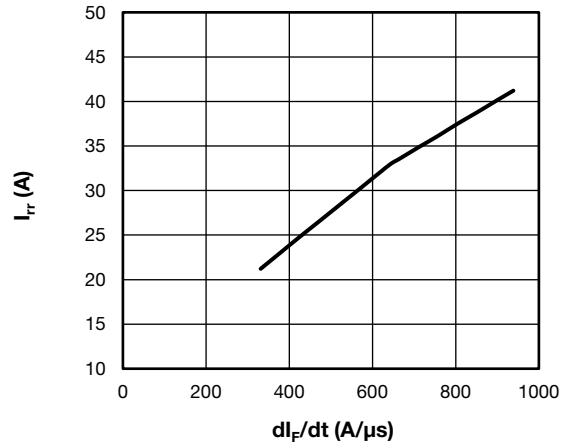

Fig. 15 - Typical Diode I_{rr} vs. dl_F/dt
 $V_{CC} = 600\text{ V}$; $V_{GE} = 15\text{ V}$; $I_{CE} = 40\text{ A}$; $T_J = 125\text{ }^\circ\text{C}$

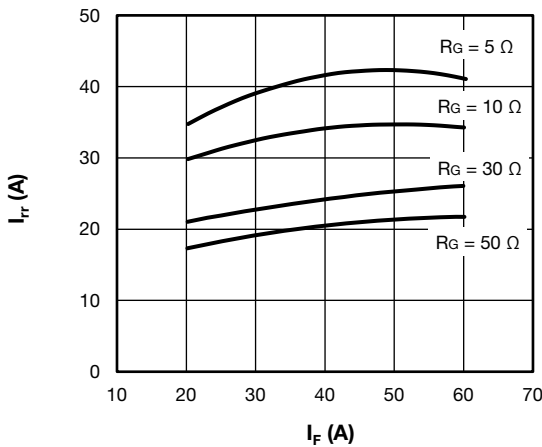

Fig. 13 - Typical Diode I_{rr} vs. I_F ,
 $T_J = 125\text{ }^\circ\text{C}$

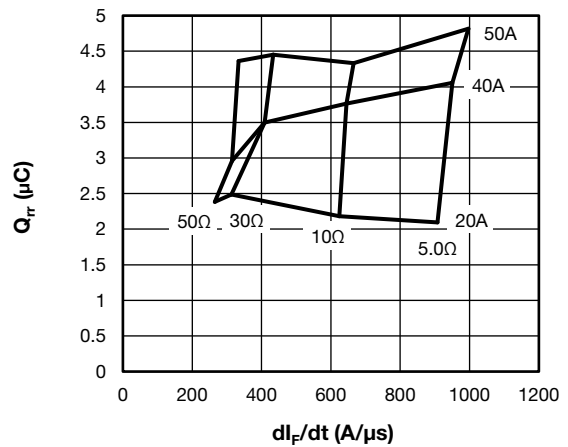

Fig. 16 - Typical Diode Q_{rr} vs. dl_F/dt
 $V_{CC} = 600\text{ V}$; $V_{GE} = 15\text{ V}$; $T_J = 125\text{ }^\circ\text{C}$

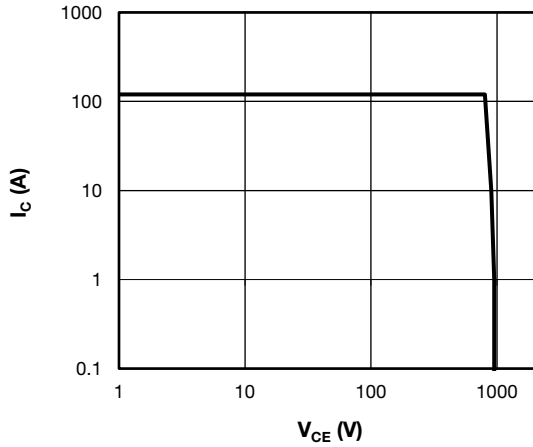

Fig. 17 - Trench IGBT Reverse BIAS SOA
 $T_J = 150\text{ }^\circ\text{C}$, $I_C = 120\text{ A}$, $R_g = 10\ \Omega$, $V_{GE} = +15\text{V} / 0\text{V}$, $V_{CC} = 800\text{ V}$,
 $V_p = 1200\text{ V}$

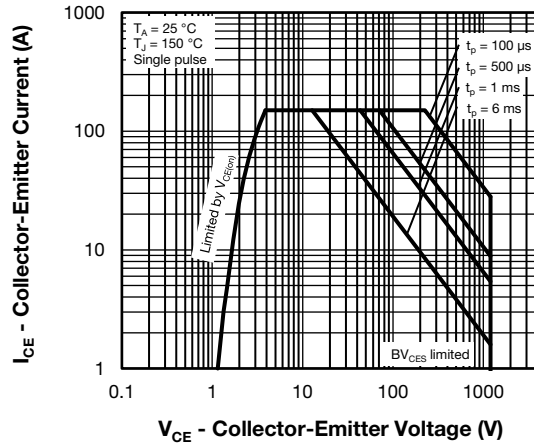

Fig. 18 - Trench IGBT Safe Operating Area

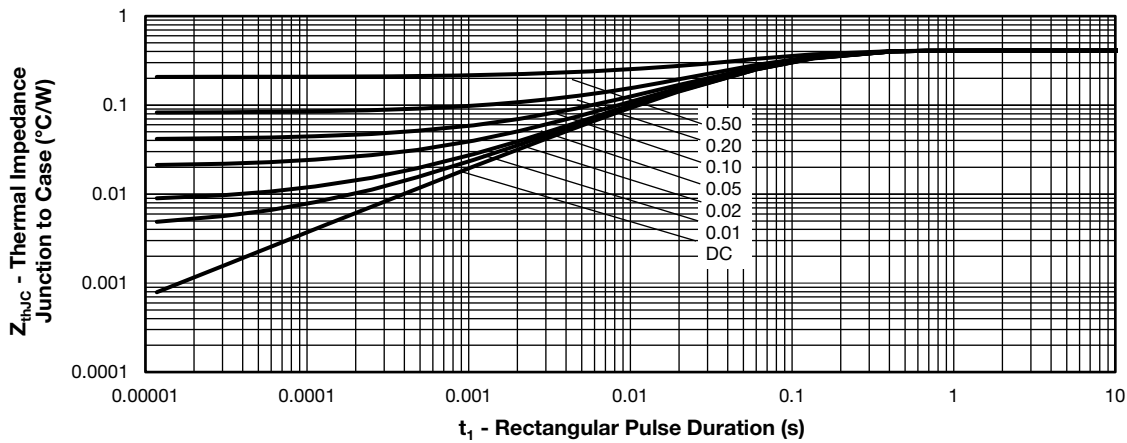

Fig. 19 - Maximum Trench IGBT Thermal Impedance Z_{thJC} Characteristics

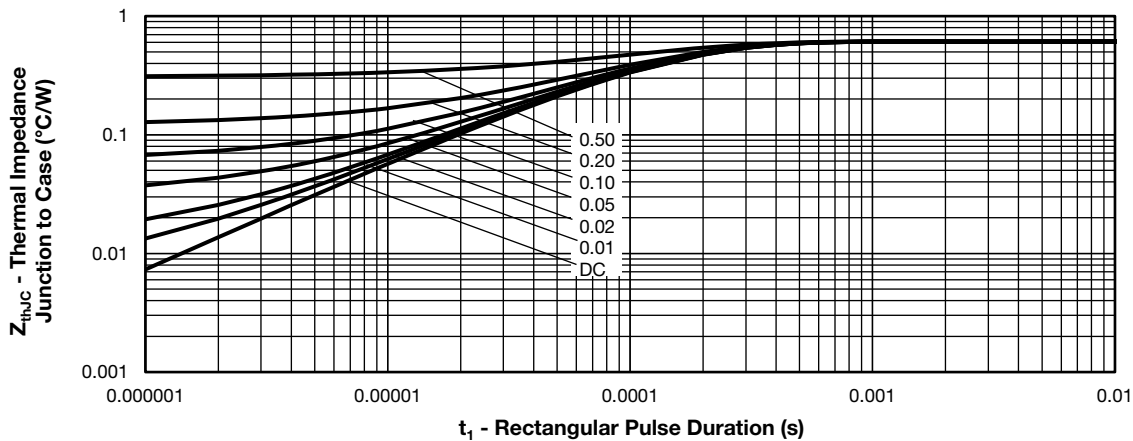

Fig. 20 - Maximum Diode Thermal Impedance Z_{thJC} Characteristics

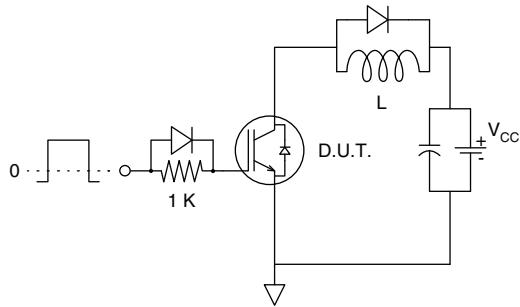

Fig. 21 - Gate Charge Circuit (Turn-Off)

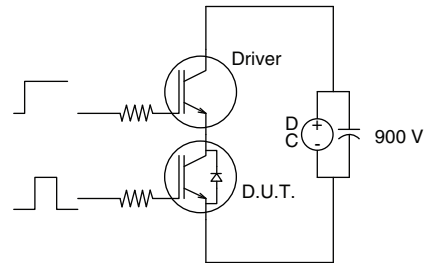

Fig. 23 - S.C. SOA Circuit

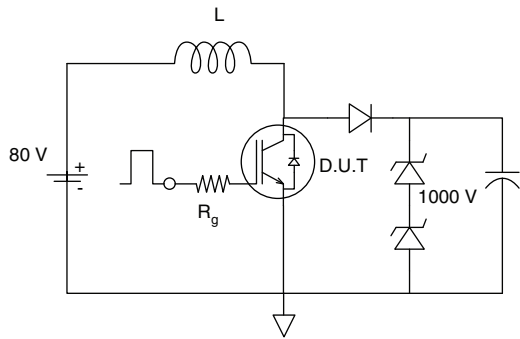

Fig. 22 - RBSOA Circuit

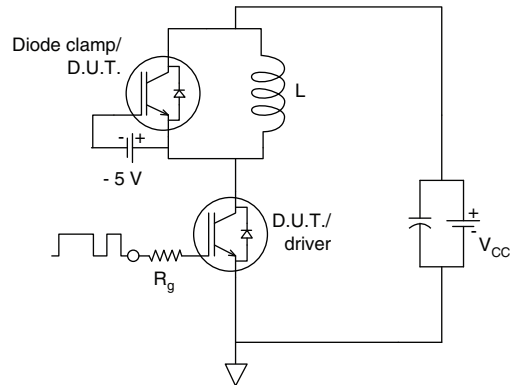

Fig. 24 - Switching Loss Circuit

ORDERING INFORMATION TABLE

Device code	VS-	40	MT	120	P	H	A	PbF
	1	2	3	4	5	6	7	8

- 1** - Vishay Semiconductors product
- 2** - Current rating (40 = 40 A)
- 3** - Essential part number
- 4** - Voltage code (120 = 1200 V)
- 5** - Speed / type (P = trench IGBT)
- 6** - Circuit configuration (H = half bridge)
- 7** - A = Al₂O₃ DBC substrate
- 8** - PbF = lead (Pb)-free



CIRCUIT CONFIGURATION

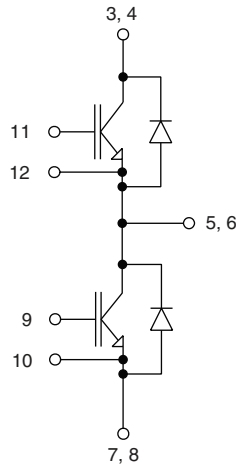

LINKS TO RELATED DOCUMENTS

LINKS TO RELATED DOCUMENTS	
Dimensions	www.vishay.com/doc?95175

MTP

DIMENSIONS in millimeters

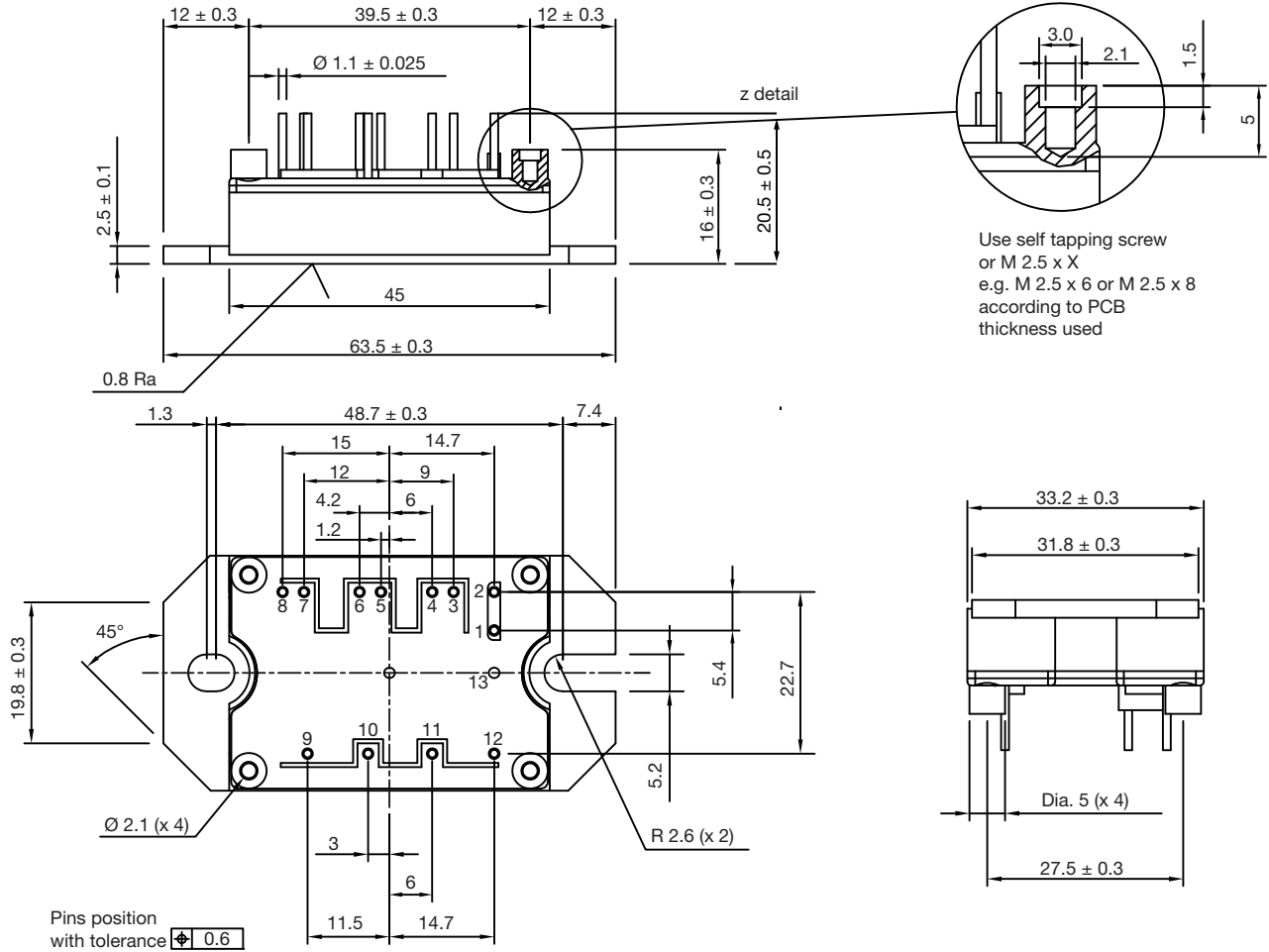

Use self tapping screw or M 2.5 x X e.g. M 2.5 x 6 or M 2.5 x 8 according to PCB thickness used

Note

- Unused terminals are not assembled in the package



Disclaimer

ALL PRODUCT, PRODUCT SPECIFICATIONS AND DATA ARE SUBJECT TO CHANGE WITHOUT NOTICE TO IMPROVE RELIABILITY, FUNCTION OR DESIGN OR OTHERWISE.

Vishay Intertechnology, Inc., its affiliates, agents, and employees, and all persons acting on its or their behalf (collectively, "Vishay"), disclaim any and all liability for any errors, inaccuracies or incompleteness contained in any datasheet or in any other disclosure relating to any product.

Vishay makes no warranty, representation or guarantee regarding the suitability of the products for any particular purpose or the continuing production of any product. To the maximum extent permitted by applicable law, Vishay disclaims (i) any and all liability arising out of the application or use of any product, (ii) any and all liability, including without limitation special, consequential or incidental damages, and (iii) any and all implied warranties, including warranties of fitness for particular purpose, non-infringement and merchantability.

Statements regarding the suitability of products for certain types of applications are based on Vishay's knowledge of typical requirements that are often placed on Vishay products in generic applications. Such statements are not binding statements about the suitability of products for a particular application. It is the customer's responsibility to validate that a particular product with the properties described in the product specification is suitable for use in a particular application. Parameters provided in datasheets and / or specifications may vary in different applications and performance may vary over time. All operating parameters, including typical parameters, must be validated for each customer application by the customer's technical experts. Product specifications do not expand or otherwise modify Vishay's terms and conditions of purchase, including but not limited to the warranty expressed therein.

Hyperlinks included in this datasheet may direct users to third-party websites. These links are provided as a convenience and for informational purposes only. Inclusion of these hyperlinks does not constitute an endorsement or an approval by Vishay of any of the products, services or opinions of the corporation, organization or individual associated with the third-party website. Vishay disclaims any and all liability and bears no responsibility for the accuracy, legality or content of the third-party website or for that of subsequent links.

Except as expressly indicated in writing, Vishay products are not designed for use in medical, life-saving, or life-sustaining applications or for any other application in which the failure of the Vishay product could result in personal injury or death. Customers using or selling Vishay products not expressly indicated for use in such applications do so at their own risk. Please contact authorized Vishay personnel to obtain written terms and conditions regarding products designed for such applications.

No license, express or implied, by estoppel or otherwise, to any intellectual property rights is granted by this document or by any conduct of Vishay. Product names and markings noted herein may be trademarks of their respective owners.