

IGBT ECONO 3 Module, 100 A

ECONO 3, 4 pack

FEATURES

- Trench gate field stop IGBT
- 5 μ s short circuit capability
- Square RBSOA
- HEXFRED low Q_{rr} , low switching energy
- Positive $V_{CE(on)}$ temperature coefficient
- Copper baseplate
- Low stray inductance design
- UL approved file E78996
- Material categorization: for definitions of compliance please see www.vishay.com/doc?99912

**RoHS
COMPLIANT**

PRIMARY CHARACTERISTICS

V_{CES}	1200 V
$I_C(DC)$ at $T_C = 93\text{ }^\circ\text{C}$	100 A
$V_{CE(on)}$ typ. at 100 A	2.12 V
Package	ECONO 3
Circuit configuration	4 pack with thermistor

BENEFITS

- Benchmark efficiency for SMPS appreciation in particular HF welding
- Rugged transient performance
- Low EMI, requires less snubbing
- Direct mounting to heatsink space saving
- PCB solderable terminals
- Low junction to case thermal resistance

ABSOLUTE MAXIMUM RATINGS

PARAMETER	SYMBOL	TEST CONDITIONS	MAX.	UNITS	
Collector to emitter voltage	V_{CES}		1200	V	
Continuous collector current	I_C	$T_C = 25\text{ }^\circ\text{C}$	170	A	
		$T_C = 80\text{ }^\circ\text{C}$	115		
Pulsed collector current	I_{CM}		500		
Clamped inductive load current	I_{LM}		250		
Diode continuous forward current	I_F	$T_C = 25\text{ }^\circ\text{C}$	71		
		$T_C = 80\text{ }^\circ\text{C}$	49		
Diode maximum forward current	I_{FSM}		370		
Gate to emitter voltage	V_{GE}		± 20	V	
Power dissipation	IGBT	P_D	$T_C = 25\text{ }^\circ\text{C}$	595	W
			$T_C = 80\text{ }^\circ\text{C}$	333	
MODULE					
Operating junction temperature range	T_J		-40 to +150	$^\circ\text{C}$	
Storage temperature range	T_{Stg}		-40 to +150		
RMS isolation voltage	V_{ISOL}	Any terminal to case, $t = 1\text{ s}$	3500	V	



ELECTRICAL SPECIFICATIONS ($T_J = 25\text{ }^\circ\text{C}$ unless otherwise specified)						
PARAMETER	SYMBOL	TEST CONDITIONS	MIN.	TYP.	MAX.	UNITS
Collector to emitter breakdown voltage	$V_{(BR)CES}$	$V_{GE} = 0\text{ V}, I_C = 6\text{ mA}$	1200	-	-	V
Collector to emitter voltage	$V_{CE(on)}$	$V_{GE} = 15\text{ V}, I_C = 50\text{ A}$	-	1.8	-	
		$V_{GE} = 15\text{ V}, I_C = 100\text{ A}$	-	2.12	2.43	
		$V_{GE} = 15\text{ V}, I_C = 50\text{ A}, T_J = 125\text{ }^\circ\text{C}$	-	1.88	-	
		$V_{GE} = 15\text{ V}, I_C = 100\text{ A}, T_J = 125\text{ }^\circ\text{C}$	-	2.35	-	
Gate threshold voltage	$V_{GE(th)}$	$V_{CE} = V_{GE}, I_C = 6\text{ mA}$	4.6	5.8	7.6	
Temperature coefficient of threshold voltage	$\Delta V_{GE(th)}/\Delta T_J$	$V_{CE} = V_{GE}, I_C = 6\text{ mA}$ ($25\text{ }^\circ\text{C}$ to $125\text{ }^\circ\text{C}$)	-	-12.3	-	mV/ $^\circ\text{C}$
Collector to emitter leaking current	I_{CES}	$V_{GE} = 0\text{ V}, V_{CE} = 1200\text{ V}$	-	1.1	75	μA
		$V_{GE} = 0\text{ V}, V_{CE} = 1200\text{ V}, T_J = 125\text{ }^\circ\text{C}$	-	0.72	-	mA
Diode forward voltage drop	V_{FM}	$I_F = 50\text{ A}, V_{GE} = 0\text{ V}$	-	2.59	3.15	V
		$I_F = 100\text{ A}, V_{GE} = 0\text{ V}$	-	3.38	-	
		$I_F = 50\text{ A}, V_{GE} = 0\text{ V}, T_J = 125\text{ }^\circ\text{C}$	-	2.69	-	
		$I_F = 100\text{ A}, V_{GE} = 0\text{ V}, T_J = 125\text{ }^\circ\text{C}$	-	3.74	-	
Gate to emitter leakage current	I_{GES}	$V_{GE} = \pm 20\text{ V}$	-	-	± 750	nA

SWITCHING CHARACTERISTICS ($T_J = 25\text{ }^\circ\text{C}$ unless otherwise specified)							
PARAMETER	SYMBOL	TEST CONDITIONS	MIN.	TYP.	MAX.	UNITS	
Total gate charge (turn-on)	Q_g	$I_C = 100\text{ A}, V_{CC} = 960\text{ V}, V_{GE} = 15\text{ V}$	-	455	-	nC	
Gate to emitter charge (turn-on)	Q_{ge}		-	51	-		
Gate to collector charge (turn-on)	Q_{gc}		-	211	-		
Turn-on switching loss	E_{on}	$I_C = 100\text{ A}, V_{CC} = 600\text{ V}, V_{GE} = 15\text{ V}, R_g = 4.7\text{ }\Omega, L = 500\text{ }\mu\text{H}, T_J = 25\text{ }^\circ\text{C}$	-	2.82	-	mJ	
Turn-off switching loss	E_{off}		-	3.47	-		
Total switching loss	E_{tot}		-	6.29	-		
Turn-on switching loss	E_{on}	$I_C = 100\text{ A}, V_{CC} = 600\text{ V}, V_{GE} = 15\text{ V}, R_g = 4.7\text{ }\Omega, L = 500\text{ }\mu\text{H}, T_J = 125\text{ }^\circ\text{C}$	-	4.09	-	mJ	
Turn-off switching loss	E_{off}		-	5.67	-		
Total switching loss	E_{tot}		-	9.76	-		
Turn-on delay time	$t_{d(on)}$	$I_C = 100\text{ A}, V_{CC} = 600\text{ V}, V_{GE} = 15\text{ V}, R_g = 4.7\text{ }\Omega, L = 500\text{ }\mu\text{H}, T_J = 125\text{ }^\circ\text{C}$	-	63	-	ns	
Rise time	t_r		-	28	-		
Turn-off delay time	$t_{d(off)}$		-	222	-		
Fall time	t_f		-	150	-		
Reverse bias safe operating area	RBSOA	$T_J = 150\text{ }^\circ\text{C}, I_C = 250\text{ A}, V_{GE} = 15\text{ V to } 0\text{ V}, R_g = 4.7\text{ }\Omega, V_{CC} = 700\text{ V}, V_p = 1200\text{ V}$	Full square				
Short circuit safe operating area	SCSOA	$V_{CC} = 600\text{ V}, V_{GE} = 15\text{ V}, T_J = 150\text{ }^\circ\text{C}$	-	-	5	μs	
Diode reverse recovery time	t_{rr}	$I_F = 50\text{ A}, dI_F/dt = 200\text{ A}/\mu\text{s}, V_R = 400\text{ V}$	$T_J = 25\text{ }^\circ\text{C}$	-	190	-	ns
			$T_J = 125\text{ }^\circ\text{C}$	-	293	-	
Diode peak reverse current	I_{rr}		$T_J = 25\text{ }^\circ\text{C}$	-	12	-	A
			$T_J = 125\text{ }^\circ\text{C}$	-	18.6	-	
Diode recovery charge	Q_{rr}		$T_J = 25\text{ }^\circ\text{C}$	-	1140	-	nC
			$T_J = 125\text{ }^\circ\text{C}$	-	2725	-	



INTERNAL NTC - THERMISTOR SPECIFICATIONS				
PARAMETER	SYMBOL	TEST CONDITIONS	VALUE	UNITS
Resistance	R25	$T_C = 25\text{ }^\circ\text{C}$	5000	Ω
	R100	$T_C = 100\text{ }^\circ\text{C}$	$493 \pm 5\%$	
B-value	$B_{25/50}$	$R_2 = R_{25} \exp. [B_{25/50} (1/T_2 - 1/(298.15\text{ K}))]$	$3375 \pm 5\%$	K
Maximum operating temperature			220	$^\circ\text{C}$
Dissipation constant			2	mW/ $^\circ\text{C}$
Thermal time constant			8	s

THERMAL AND MECHANICAL SPECIFICATIONS					
PARAMETER	SYMBOL	MIN.	TYP.	MAX.	UNITS
IGBT - junction-to-case (per switch)	R_{thJC}	-	-	0.21	$^\circ\text{C/W}$
DIODE - junction-to-case (per diode)	R_{thJC}	-	-	0.46	
Case to sink, flat, greased surface (per module)	R_{thJS}	-	0.015	-	
Mounting torque (M5)		3.0	-	6.0	Nm
Weight		-	285	-	g

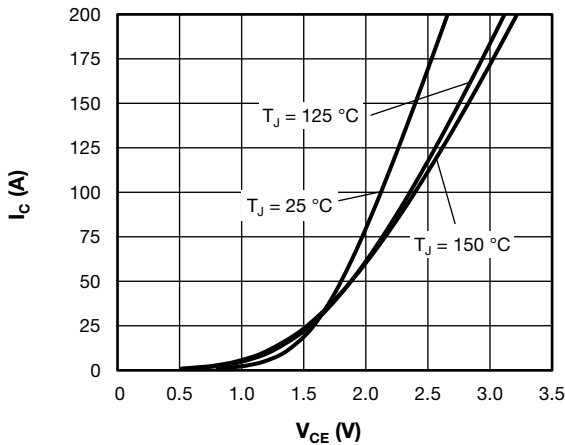

Fig. 1 - Typical Trench IGBT Output Characteristics, $V_{GE} = 15\text{ V}$

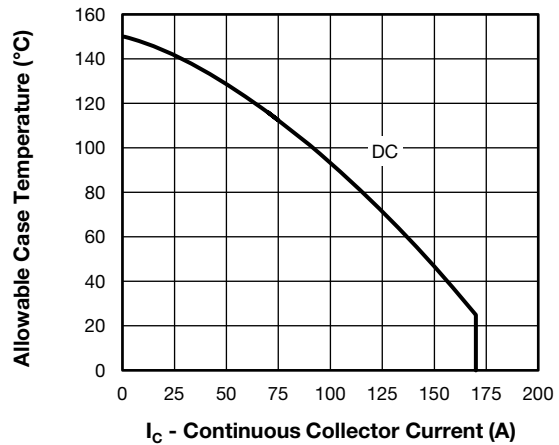

Fig. 3 - Maximum Trench IGBT Continuous Collector Current vs. Case Temperature

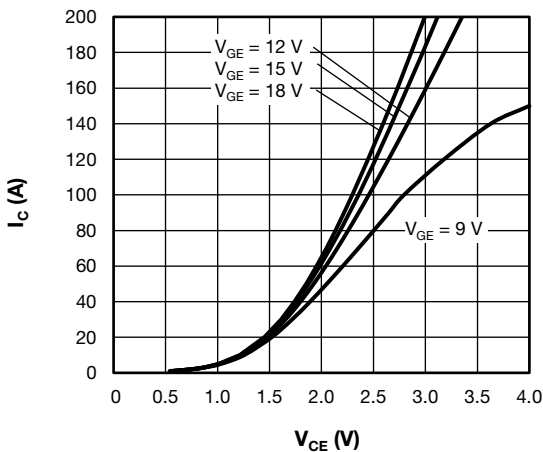

Fig. 2 - Typical Trench IGBT Output Characteristics, $T_J = 125\text{ }^\circ\text{C}$

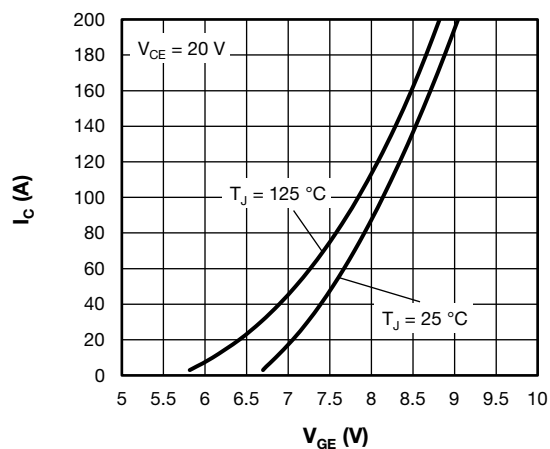

Fig. 4 - Typical Trench IGBT Transfer Characteristics

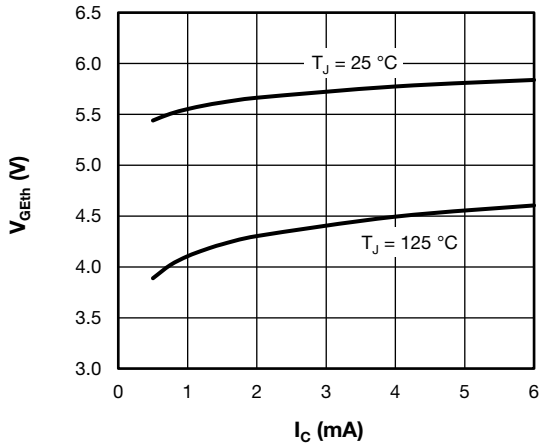

Fig. 5 - Typical Trench IGBT Gate Threshold Voltage

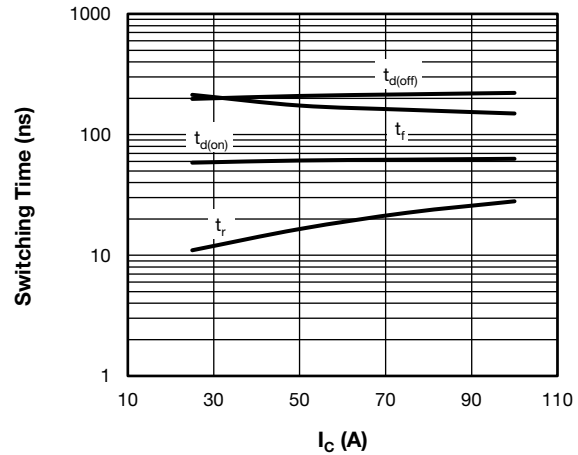

Fig. 8 - Typical Trench IGBT Switching Time vs. I_C with (Antiparallel Diode)
 $T_J = 125\text{ }^\circ\text{C}$, $V_{CC} = 600\text{ V}$, $R_g = 4.7\ \Omega$, $V_{GE} = +15\text{ V}/-15\text{ V}$, $L = 500\ \mu\text{H}$

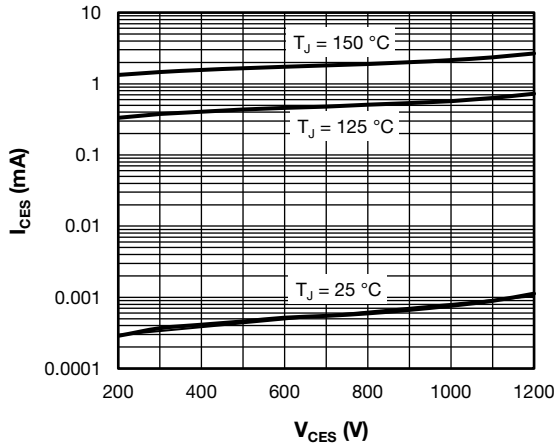

Fig. 6 - Typical Trench IGBT Zero Gate Voltage Collector Current

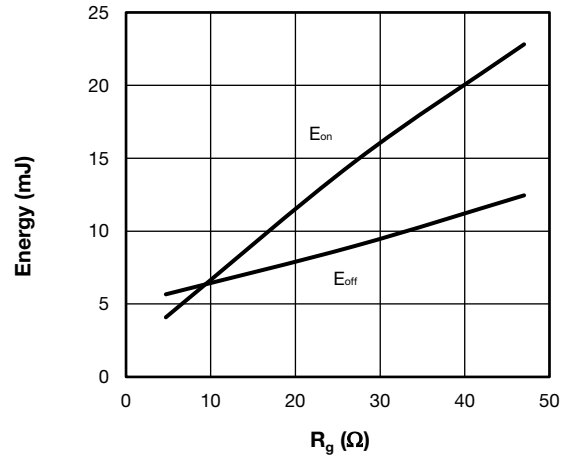

Fig. 9 - Typical Trench IGBT Energy Loss vs. R_g with (Antiparallel Diode)
 $T_J = 125\text{ }^\circ\text{C}$, $V_{CC} = 600\text{ V}$, $I_C = 100\text{ A}$, $V_{GE} = 15\text{ V}$, $L = 500\ \mu\text{H}$

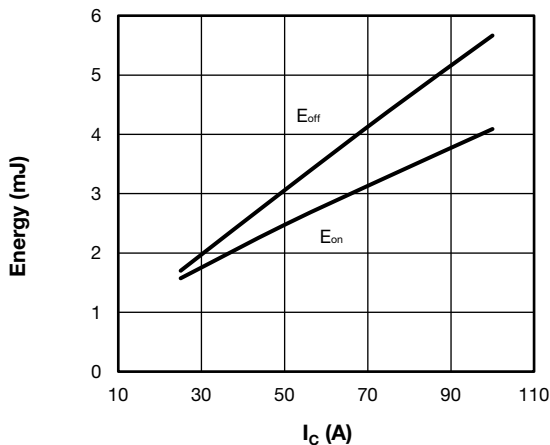

Fig. 7 - Typical IGBT Energy Loss vs. I_C with (Antiparallel Diode)
 $T_J = 125\text{ }^\circ\text{C}$, $V_{CC} = 600\text{ V}$, $R_g = 4.7\ \Omega$, $V_{GE} = +15\text{ V}/-15\text{ V}$, $L = 500\ \mu\text{H}$

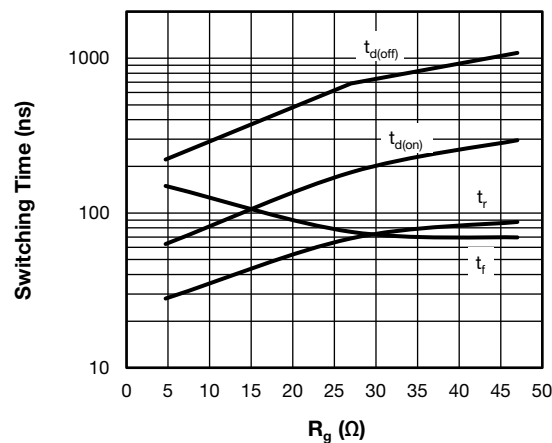

Fig. 10 - Typical Trench IGBT Switching Time vs. R_g with (Antiparallel Diode)
 $T_J = 125\text{ }^\circ\text{C}$, $V_{CC} = 600\text{ V}$, $I_C = 100\text{ A}$, $V_{GE} = 15\text{ V}$, $L = 500\ \mu\text{H}$

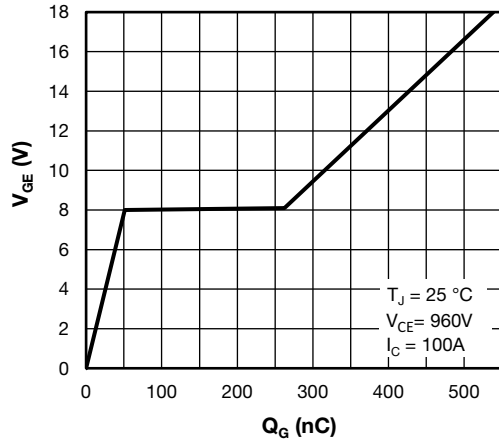

Fig. 11 - Typical Trench IGBT Gate Charge vs. Gate to Emitter Voltage

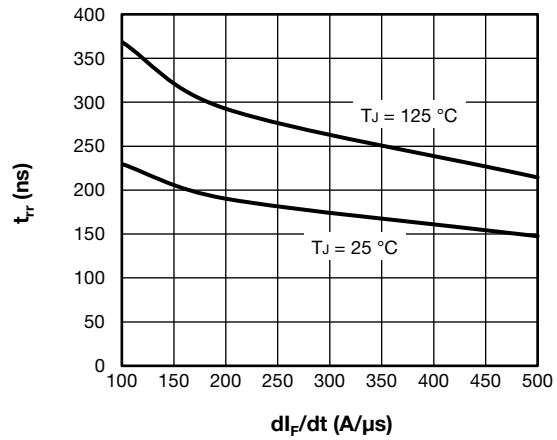

Fig. 14 - Typical Diode Reverse Recovery Time vs. di_F/dt
 $V_{rr} = 400\text{ V}$, $I_F = 50\text{ A}$

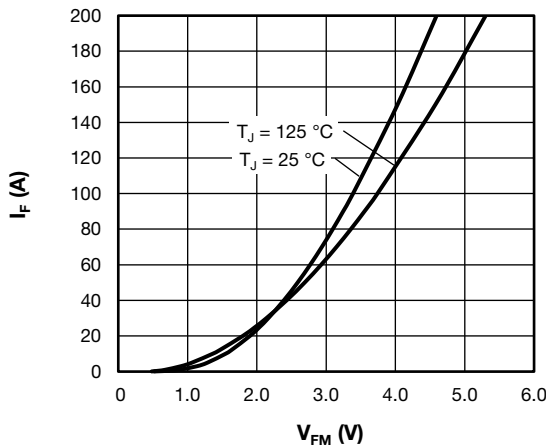

Fig. 12 - Typical Diode Forward Characteristics

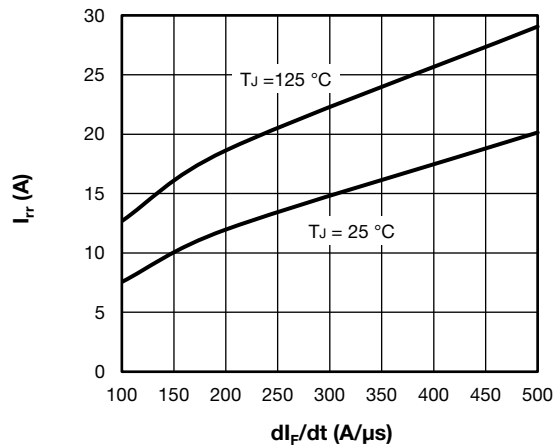

Fig. 15 - Typical Diode Reverse Recovery Current vs. di_F/dt
 $V_{rr} = 400\text{ V}$, $I_F = 50\text{ A}$

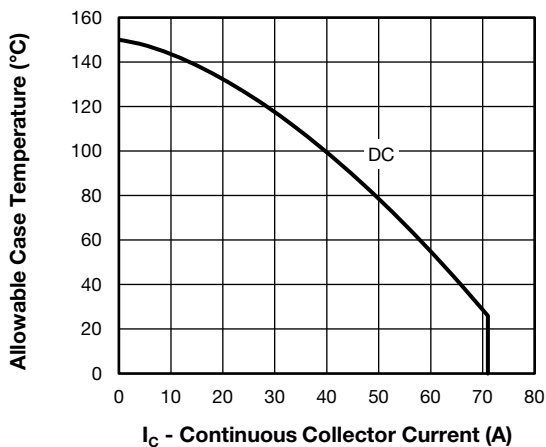

Fig. 13 - Maximum Diode Continuous Forward Current vs. Case Temperature

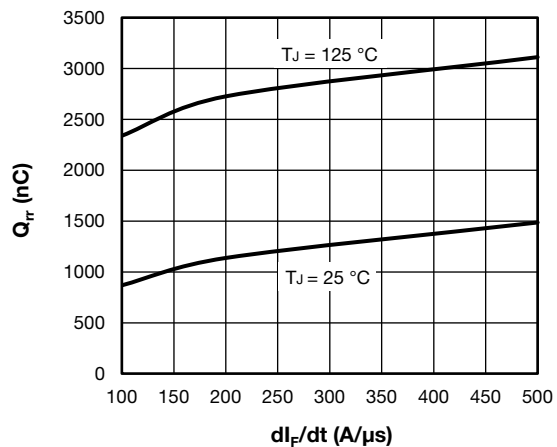

Fig. 16 - Typical Diode Reverse Recovery Charge vs. di_F/dt
 $V_{rr} = 400\text{ V}$, $I_F = 50\text{ A}$

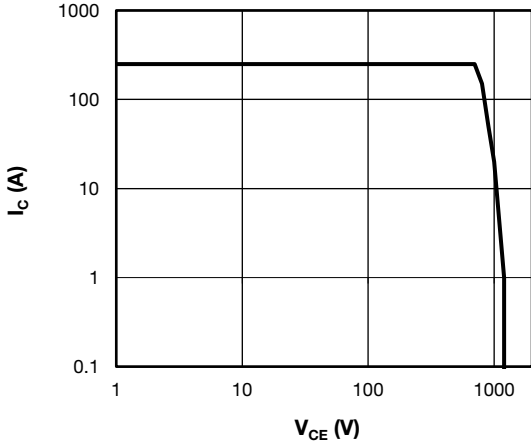

Fig. 17 - Trench IGBT Reverse BIAS SOA
 $T_J = 150\text{ }^\circ\text{C}$, $I_C = 200\text{ A}$, $R_{\theta} = 10\ \Omega$, $V_{GE} = +15\text{ V/0 V}$,
 $V_{CC} = 600\text{ V}$, $V_p = 1200\text{ V}$

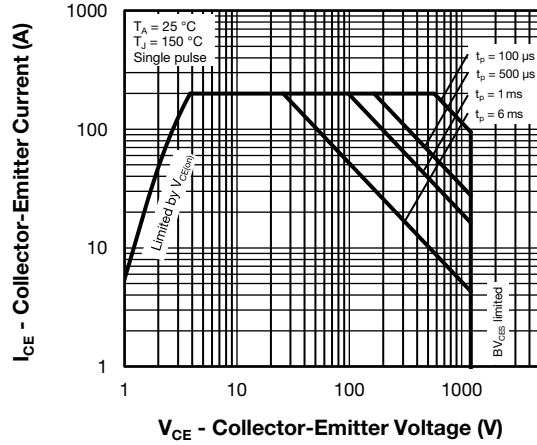

Fig. 18 - Trench IGBT Safe Operating Area

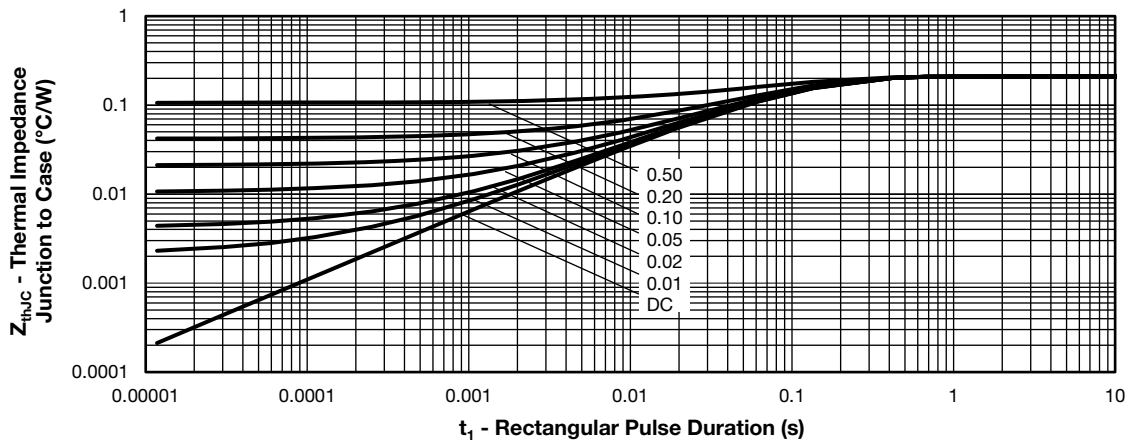

Fig. 19 - Maximum Trench IGBT Thermal Impedance Z_{thJC} Characteristics

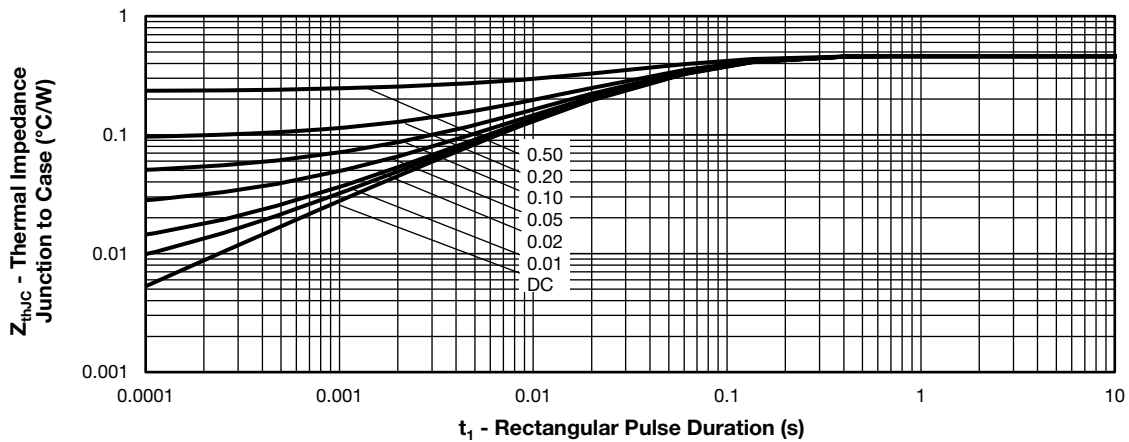

Fig. 20 - Maximum Diode Thermal Impedance Z_{thJC} Characteristics



ORDERING INFORMATION TABLE

Device code	VS-	G	T	100	Y	G	120	U	T
	1	2	3	4	5	6	7	8	9

- 1** - Vishay Semiconductors product
- 2** - Insulated gate bipolar transistor (IGBT)
- 3** - T = Trench IGBT technology
- 4** - Current rating (100 = 100 A)
- 5** - Circuit configuration (Y = 4 pack)
- 6** - Package indicator (G = ECONO 3)
- 7** - Voltage rating (120 = 1200 V)
- 8** - Speed / type (U = Ultrafast IGBT)
- 9** - NTC thermistor

CIRCUIT CONFIGURATION		
CIRCUIT	CIRCUIT CONFIGURATION CODE	CIRCUIT DRAWING
4 pack with thermistor	Y	

LINKS TO RELATED DOCUMENTS	
Dimensions	www.vishay.com/doc?95686



ECONO3 4 Pack

DIMENSIONS in millimeters and inches

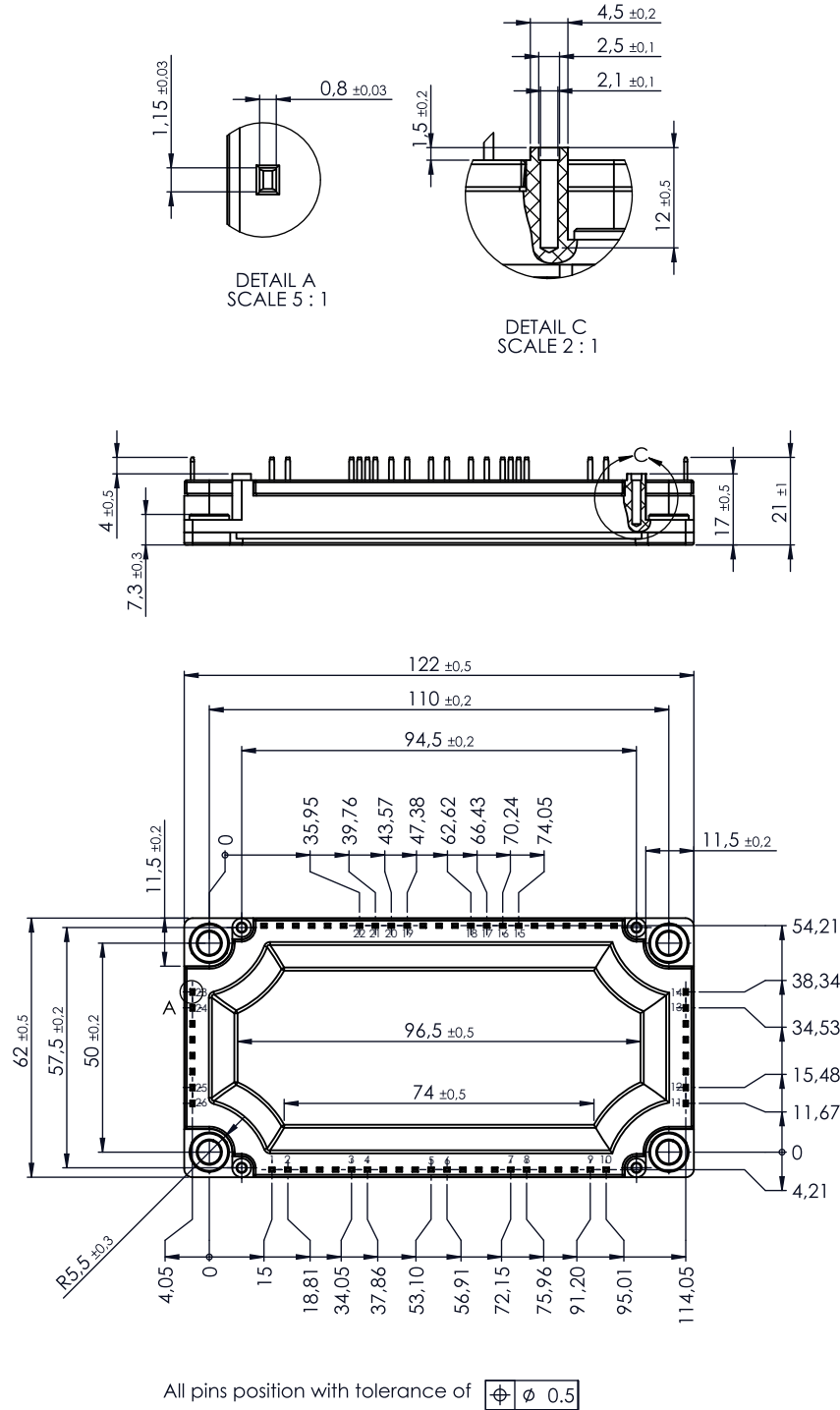



Disclaimer

ALL PRODUCT, PRODUCT SPECIFICATIONS AND DATA ARE SUBJECT TO CHANGE WITHOUT NOTICE TO IMPROVE RELIABILITY, FUNCTION OR DESIGN OR OTHERWISE.

Vishay Intertechnology, Inc., its affiliates, agents, and employees, and all persons acting on its or their behalf (collectively, "Vishay"), disclaim any and all liability for any errors, inaccuracies or incompleteness contained in any datasheet or in any other disclosure relating to any product.

Vishay makes no warranty, representation or guarantee regarding the suitability of the products for any particular purpose or the continuing production of any product. To the maximum extent permitted by applicable law, Vishay disclaims (i) any and all liability arising out of the application or use of any product, (ii) any and all liability, including without limitation special, consequential or incidental damages, and (iii) any and all implied warranties, including warranties of fitness for particular purpose, non-infringement and merchantability.

Statements regarding the suitability of products for certain types of applications are based on Vishay's knowledge of typical requirements that are often placed on Vishay products in generic applications. Such statements are not binding statements about the suitability of products for a particular application. It is the customer's responsibility to validate that a particular product with the properties described in the product specification is suitable for use in a particular application. Parameters provided in datasheets and / or specifications may vary in different applications and performance may vary over time. All operating parameters, including typical parameters, must be validated for each customer application by the customer's technical experts. Product specifications do not expand or otherwise modify Vishay's terms and conditions of purchase, including but not limited to the warranty expressed therein.

Hyperlinks included in this datasheet may direct users to third-party websites. These links are provided as a convenience and for informational purposes only. Inclusion of these hyperlinks does not constitute an endorsement or an approval by Vishay of any of the products, services or opinions of the corporation, organization or individual associated with the third-party website. Vishay disclaims any and all liability and bears no responsibility for the accuracy, legality or content of the third-party website or for that of subsequent links.

Except as expressly indicated in writing, Vishay products are not designed for use in medical, life-saving, or life-sustaining applications or for any other application in which the failure of the Vishay product could result in personal injury or death. Customers using or selling Vishay products not expressly indicated for use in such applications do so at their own risk. Please contact authorized Vishay personnel to obtain written terms and conditions regarding products designed for such applications.

No license, express or implied, by estoppel or otherwise, to any intellectual property rights is granted by this document or by any conduct of Vishay. Product names and markings noted herein may be trademarks of their respective owners.