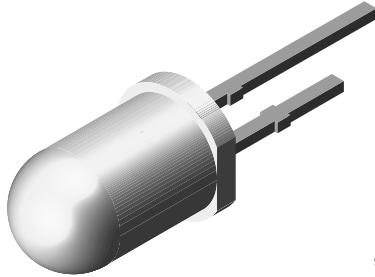


## Silicon PIN Photodiode



94 8390

### FEATURES

- Package type: leaded
- Package form: T-1 $\frac{3}{4}$
- Dimensions (in mm):  $\varnothing$  5
- Leads with stand-off
- High photo sensitivity
- High sensitivity
- Suitable for visible and near infrared radiation
- Fast response times
- Angle of half sensitivity:  $\varphi = \pm 20^\circ$
- Material categorization: for definitions of compliance please see [www.vishay.com/doc?99912](http://www.vishay.com/doc?99912)



### DESCRIPTION

BPV10 is a PIN photodiode with high speed and high sensitivity in clear, T-1 $\frac{3}{4}$  plastic package. It is sensitive to visible and near infrared radiation.

### APPLICATIONS

- High speed photo detector

### PRODUCT SUMMARY

COMPONENT	$I_{ra}$ ( $\mu$ A)	$\varphi$ ( $^\circ$ )	$\lambda_{0.1}$ (nm)
BPV10	70	$\pm 20$	380 to 1100

#### Note

- Test condition see table "Basic Characteristics"

### ORDERING INFORMATION

ORDERING CODE	PACKAGING	REMARKS	PACKAGE FORM
BPV10	Bulk	MOQ: 4000 pcs, 4000 pcs/bulk	T-1 $\frac{3}{4}$

#### Note

- MOQ: minimum order quantity

### ABSOLUTE MAXIMUM RATINGS ( $T_{amb} = 25^\circ\text{C}$ , unless otherwise specified)

PARAMETER	TEST CONDITION	SYMBOL	VALUE	UNIT
Reverse voltage		$V_R$	60	V
Power dissipation	$T_{amb} \leq 25^\circ\text{C}$	$P_V$	215	mW
Junction temperature		$T_j$	100	$^\circ\text{C}$
Operating temperature range		$T_{amb}$	-40 to +100	$^\circ\text{C}$
Storage temperature range		$T_{stg}$	-40 to +100	$^\circ\text{C}$
Soldering temperature	$t \leq 5$ s, 2 mm from body	$T_{sd}$	260	$^\circ\text{C}$
Thermal resistance junction to ambient	Connected with Cu wire, 0.14 mm <sup>2</sup>	$R_{thJA}$	350	K/W

<b>BASIC CHARACTERISTICS</b> ( $T_{amb} = 25\text{ }^{\circ}\text{C}$ , unless otherwise specified)						
PARAMETER	TEST CONDITION	SYMBOL	MIN.	TYP.	MAX.	UNIT
Forward voltage	$I_F = 50\text{ mA}$	$V_F$	-	1.0	1.3	V
Breakdown voltage	$I_R = 100\text{ }\mu\text{A}$ , $E = 0$	$V_{(BR)}$	60	-	-	V
Reverse dark current	$V_R = 20\text{ V}$ , $E = 0$	$I_{ro}$	-	0.1	5	nA
Diode capacitance	$V_R = 0\text{ V}$ , $f = 1\text{ MHz}$ , $E = 0$	$C_D$	-	11	-	pF
	$V_R = 5\text{ V}$ , $f = 1\text{ MHz}$ , $E = 0$	$C_D$	-	3.8	-	pF
Open circuit voltage	$E_A = 1\text{ klx}$	$V_O$	-	480	-	mV
	$E_e = 1\text{ mW/cm}^2$ , $\lambda = 950\text{ nm}$	$V_O$	-	450	-	mV
Short circuit current	$E_A = 1\text{ klx}$	$I_K$	-	80	-	$\mu\text{A}$
	$E_e = 1\text{ mW/cm}^2$ , $\lambda = 950\text{ nm}$	$I_K$	-	65	-	$\mu\text{A}$
Reverse light current	$E_A = 1\text{ klx}$ , $V_R = 5\text{ V}$	$I_{ra}$	-	85	-	$\mu\text{A}$
	$E_e = 1\text{ mW/cm}^2$ , $\lambda = 950\text{ nm}$ , $V_R = 5\text{ V}$	$I_{ra}$	38	70	-	$\mu\text{A}$
Absolute spectral sensitivity	$V_R = 5\text{ V}$ , $\lambda = 950\text{ nm}$	$s(\lambda)$	-	0.55	-	A/W
Angle of half sensitivity		$\varphi$	-	$\pm 20$	-	$^{\circ}$
Wavelength of peak sensitivity		$\lambda_p$	-	920	-	nm
Range of spectral bandwidth		$\lambda_{0.1}$	-	380 to 1100	-	nm
Quantum efficiency	$\lambda = 950\text{ nm}$	$\eta$	-	72	-	%
Noise equivalent power	$V_R = 20\text{ V}$ , $\lambda = 950\text{ nm}$	NEP	-	$3 \times 10^{-14}$	-	W/ $\sqrt{\text{Hz}}$
Detectivity	$V_R = 20\text{ V}$ , $\lambda = 950\text{ nm}$	D	-	$3 \times 10^{12}$	-	$\text{cm}\sqrt{\text{Hz/W}}$
Rise time	$V_R = 10\text{ V}$ , $R_L = 50\text{ }\Omega$ , $\lambda = 830\text{ nm}$	$t_r$	-	80	-	ns
Fall time	$V_R = 10\text{ V}$ , $R_L = 50\text{ }\Omega$ , $\lambda = 830\text{ nm}$	$t_f$	-	60	-	ns

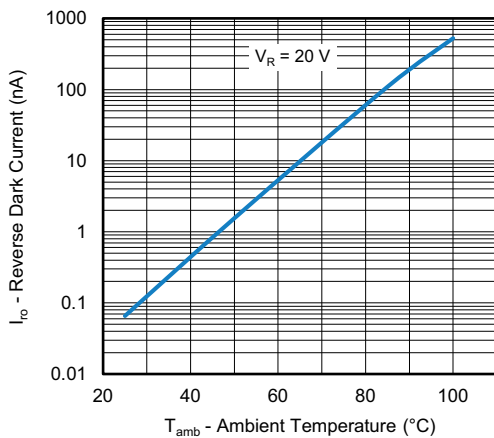
**BASIC CHARACTERISTICS** ( $T_{amb} = 25\text{ }^{\circ}\text{C}$ , unless otherwise specified)


Fig. 1 - Reverse Dark Current vs. Ambient Temperature

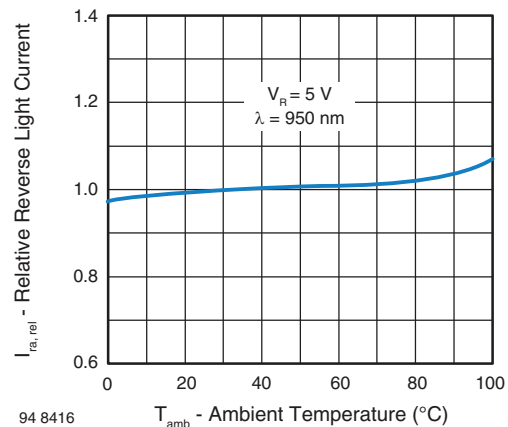
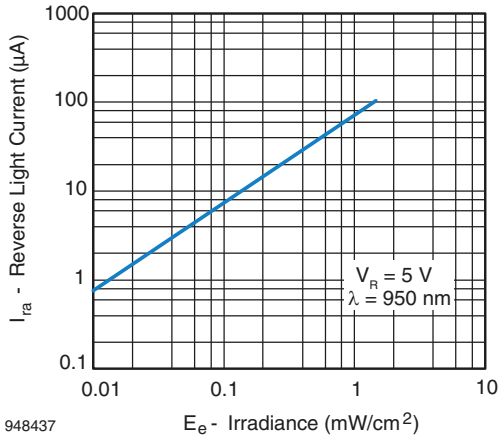
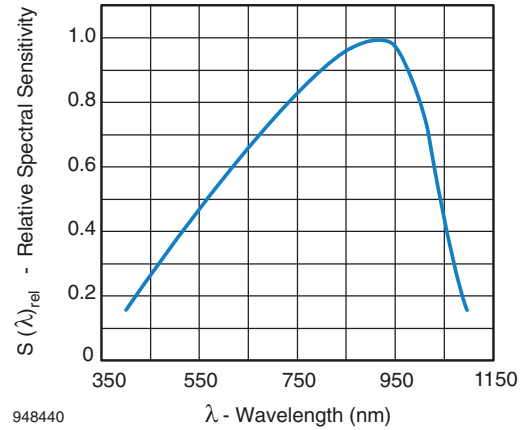


Fig. 2 - Relative Reverse Light Current vs. Ambient Temperature



948437

Fig. 3 - Reverse Light Current vs. Irradiance



948440

Fig. 6 - Relative Spectral Sensitivity vs. Wavelength

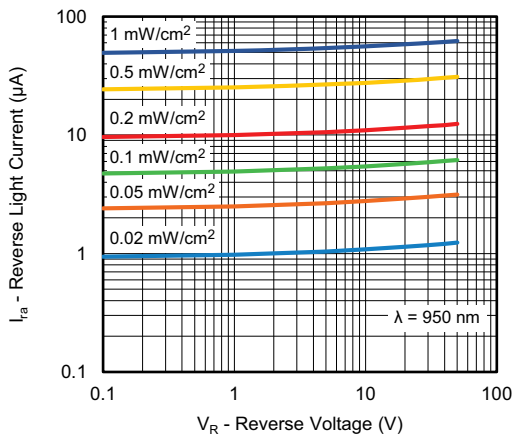
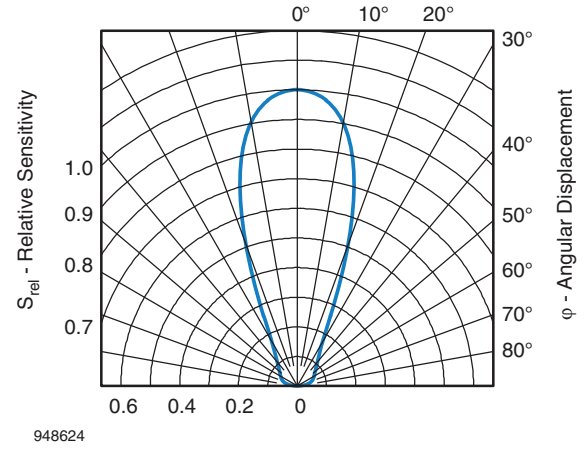
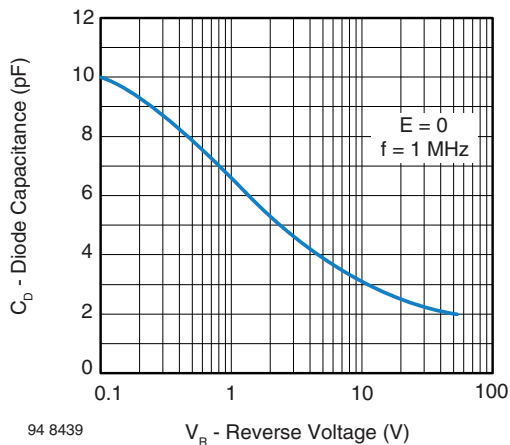


Fig. 4 - Reverse Light Current vs. Reverse Voltage



948624

Fig. 7 - Relative Sensitivity vs. Angular Displacement

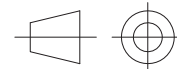
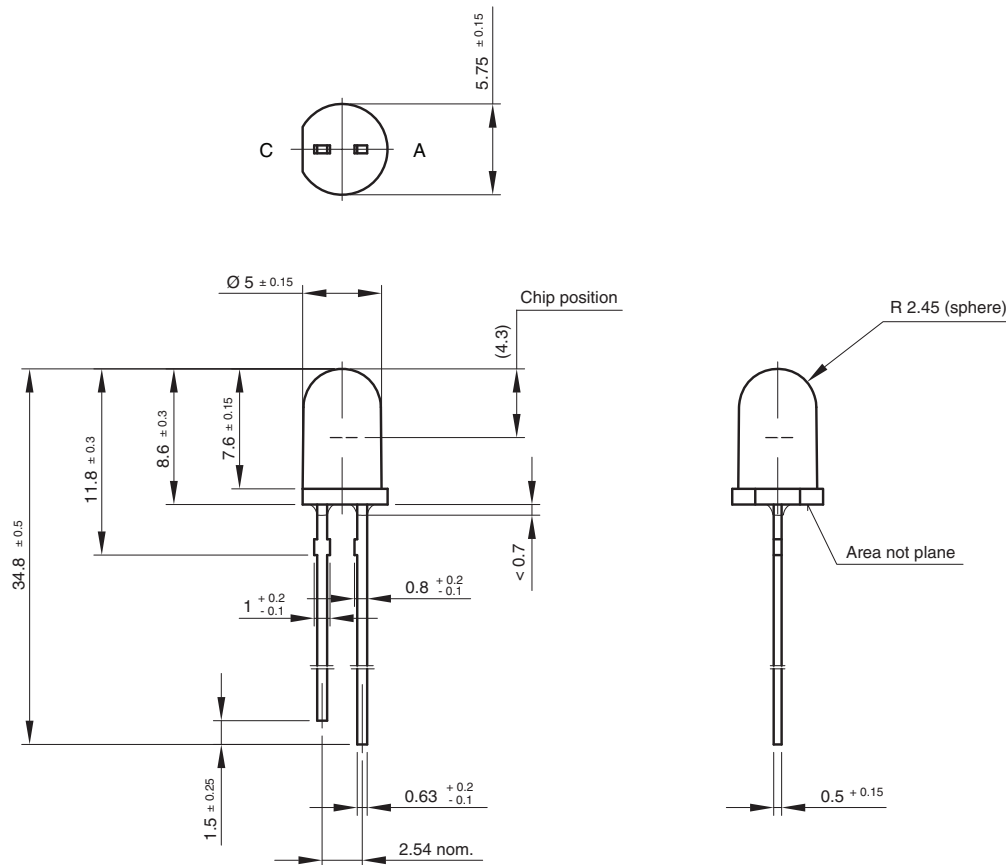


94 8439

Fig. 5 - Diode Capacitance vs. Reverse Voltage



PACKAGE DIMENSIONS in millimeters



technical drawings according to DIN specifications

Drawing-No.: 6.544-5185.02-4

Issue:1; 01.07.96

96 12199



## Disclaimer

ALL PRODUCT, PRODUCT SPECIFICATIONS AND DATA ARE SUBJECT TO CHANGE WITHOUT NOTICE TO IMPROVE RELIABILITY, FUNCTION OR DESIGN OR OTHERWISE.

Vishay Intertechnology, Inc., its affiliates, agents, and employees, and all persons acting on its or their behalf (collectively, "Vishay"), disclaim any and all liability for any errors, inaccuracies or incompleteness contained in any datasheet or in any other disclosure relating to any product.

Vishay makes no warranty, representation or guarantee regarding the suitability of the products for any particular purpose or the continuing production of any product. To the maximum extent permitted by applicable law, Vishay disclaims (i) any and all liability arising out of the application or use of any product, (ii) any and all liability, including without limitation special, consequential or incidental damages, and (iii) any and all implied warranties, including warranties of fitness for particular purpose, non-infringement and merchantability.

Statements regarding the suitability of products for certain types of applications are based on Vishay's knowledge of typical requirements that are often placed on Vishay products in generic applications. Such statements are not binding statements about the suitability of products for a particular application. It is the customer's responsibility to validate that a particular product with the properties described in the product specification is suitable for use in a particular application. Parameters provided in datasheets and / or specifications may vary in different applications and performance may vary over time. All operating parameters, including typical parameters, must be validated for each customer application by the customer's technical experts. Product specifications do not expand or otherwise modify Vishay's terms and conditions of purchase, including but not limited to the warranty expressed therein.

Hyperlinks included in this datasheet may direct users to third-party websites. These links are provided as a convenience and for informational purposes only. Inclusion of these hyperlinks does not constitute an endorsement or an approval by Vishay of any of the products, services or opinions of the corporation, organization or individual associated with the third-party website. Vishay disclaims any and all liability and bears no responsibility for the accuracy, legality or content of the third-party website or for that of subsequent links.

Except as expressly indicated in writing, Vishay products are not designed for use in medical, life-saving, or life-sustaining applications or for any other application in which the failure of the Vishay product could result in personal injury or death. Customers using or selling Vishay products not expressly indicated for use in such applications do so at their own risk. Please contact authorized Vishay personnel to obtain written terms and conditions regarding products designed for such applications.

No license, express or implied, by estoppel or otherwise, to any intellectual property rights is granted by this document or by any conduct of Vishay. Product names and markings noted herein may be trademarks of their respective owners.