

Non-Linear Resistors

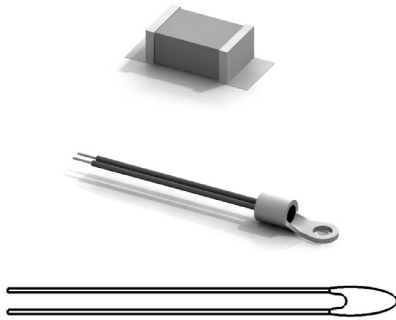

FEATURES

- Free CAD parts library with Vishay 2D drawings and 3D models of Non-Linear Resistors
- No login required for browsing the catalog
Login required only for downloading the models
- Exact geometrical dimensions allows you to scale the Vishay models into your design
- Includes all the features you need to assemble and fit the 3D models into your design
- Includes SMD component footprints and layout configurations for printed circuit board designs

AVAILABLE CAD FORMATS FOR DOWNLOAD

3D native formats: CATIA | INVENTOR | MECHANICAL DESKTOP | Pro/ENGINEER | SOLID EDGE | SOLIDWORKS | THINKDESIGN | TOPSOLID | UNIGRAPHICS | ⁽¹⁾

3D neutral formats: ACIS | IGES | PARASOLID | STEP AP203 | STEP AP214

3D other formats: Alibre | Architectural Desktop | AutoCAD | CADKEY | HiCAD | IntelliCAD | IronCAD | Kompas 3D | MegaCAD | MicroStation | Solid Designer | TurboCAD | ⁽¹⁾

2D: DWG (7 views) | DXF (7 views) | ⁽¹⁾

DIRECTLY INTEGRATE A VISHAY MODEL IN YOUR DESIGN

1. Choose the model to be downloaded in the Vishay catalog (refer to page 2 for details)
2. Download and unzip the model
3. Integrate directly in your design

Browse Vishay Catalog

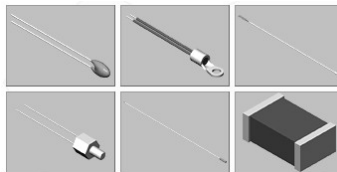

Download and unzip

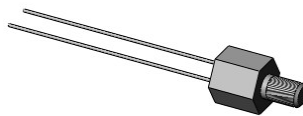

Easy integrate the Vishay model in your design

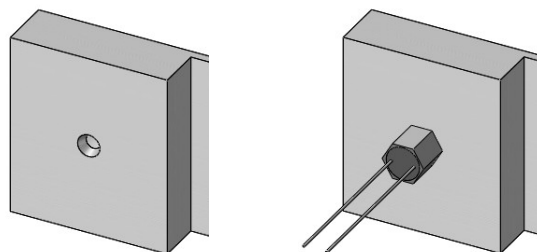

Note

⁽¹⁾ Trademarks are deposited by the respective owners



DETAILED INSTRUCTIONS FOR 3D CONTENT CENTRAL

1. Access to the URL:

www.3dcontentcentral.com (1)

2. Type "Vishay" in the search box.

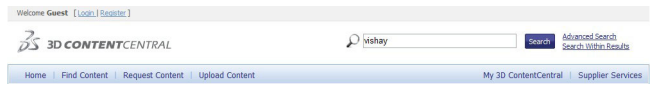

3. Filter by "Vishay Intertechnology" for the official 3D models



4. Refine the search by using additional filters, if needed.

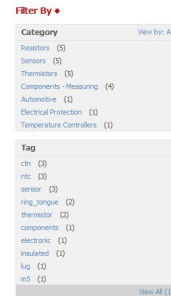

5. In the results page, click on the product picture or title.

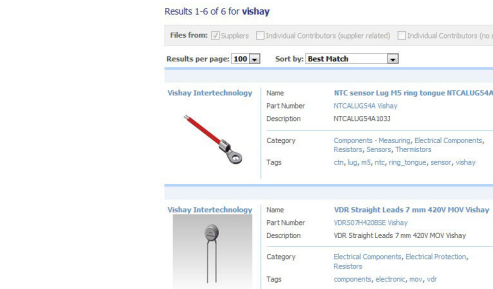

6. In the product page, select the "configure and download" (login to 3DCC web site required).

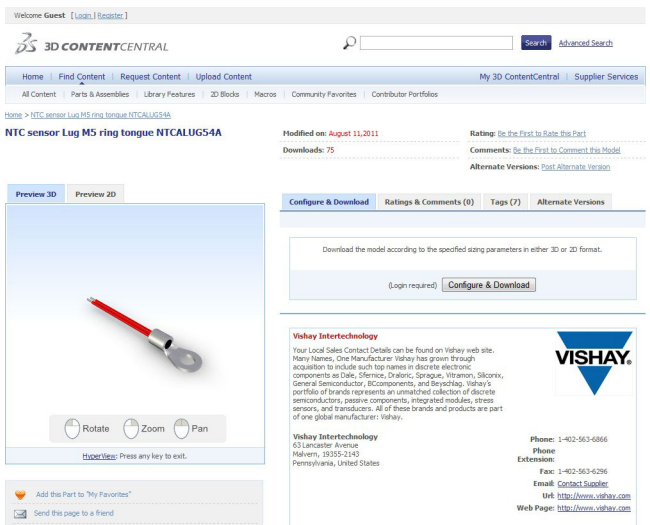

Note

(1) 3D ContentCentral® is a Trademark registered from Dassault Systèmes

7. Once logged in, choose the Format (3D or 2D), then your software format, or generic format (STEP, IGES), and the software version.



8. Click the “Download” button. The file is prepared for downloading.

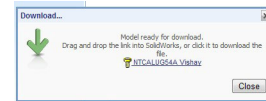

9. Save the file in your computer or server.

10. The file needs to be unzipped before use in your 3D model.

DETAILED INSTRUCTIONS FOR TRACEPARTSONLINE

1. Access to the URL:

www.tracepartsonline.net (2)

2. Choose in the list:

Vishay

or in the International ICS classification, choose

Electronics → Electronic components in general → Thermistors

or

Electrical engineering → Mechanical and electronic detection → Temperature sensor

3. Choose the model to be downloaded

Example: Surface Mount NTC Thermistors

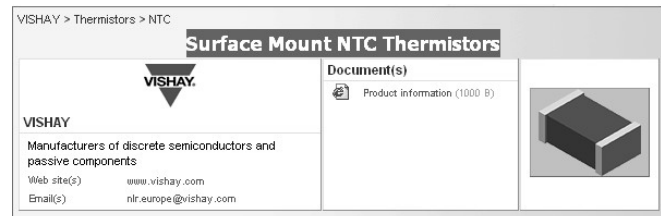

4. Select one table row

Example: 4.7 kΩ 3 %

Please select one table row below:

R25 (kohm)	Tolerance on R25	B25/R5 (K)	Tolerance on B25/R5	12 IEC Ordering code	SAP Material No.
2.2	5%	3600	±1	2381 615 53222	NTC S0805E3222JMT
2.2	3%	3600	±1	2381 615 56222	NTC S0805E3222HMT
2.2	2%	3600	±1	2381 615 54222	NTC S0805E3222GMT
2.2	1%	3600	±1	2381 615 55222	NTC S0805E3222FMT
4.7	5%	3500	±1	2381 615 53472	NTC S0805E3472JMT
4.7	3%	3500	±1	2381 615 56472	NTC S0805E3472HMT
4.7	2%	3500	±1	2381 615 54472	NTC S0805E3472GMT
4.7	1%	3500	±1	2381 615 55472	NTC S0805E3472FMT
10	5%	3570	±3	2381 615 53103	NTC S0805E3103JMT

5. Select the other configurations (if necessary)

Example: With Footprints (Pad Layout)

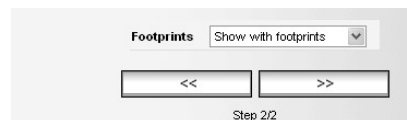

Note

(2) Trademarks are deposited by the respective owners



6. Select the CAD format for download

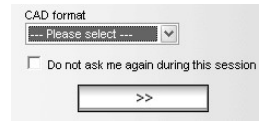

7. Click on the double arrow >>

8. Register or enter your E-mail address and password



9. On the “Caddy”, click the “Download” or “Send by e-mail” button

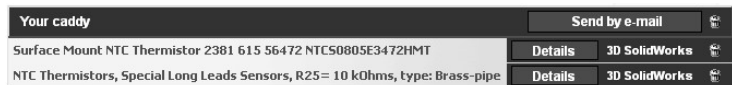

10. Save the ZIP file and Unzip the model

11. Open the CAD file in your CAD system

12. For other product details, click on

www.vishay.com to access to Vishay web site

nlr@vishay.com for technical questions on Non-Linear Resistors

Product information to access to Vishay web product page (ordering system, distributors, packaging size, etc.)

Recommendations:

If you do not receive your files by e-mail after a few minutes, it may be due to an anti-spam system. In this case add “traceparts.com” or “partsmaster@traceparts.com” to the list of authorized senders, so that messages from TraceParts Online are not blocked anymore.