

Thick Film Power Resistor With NTC (Optional)



FEATURES

- AEC-Q200 qualified
- Cold system without external radiation
- High power / volume ratio
- Cooled by auxiliary heatsink (not supplied)
- Non-inductive
- Pre-applied phase change thermal interface PC-TIM (optional)
- Internal temperature monitoring with a NTC thermistor
- Material categorization: for definitions of compliance please see www.vishay.com/doc?99912

RoHS
COMPLIANT

LINKS TO ADDITIONAL RESOURCES



APPLICATIONS

- Automotive: precharge, discharge, and active discharge
- Industrial and AMS: power conversion and snubber

STANDARD ELECTRICAL SPECIFICATIONS					
MODEL	RESISTANCE RANGE Ω ⁽¹⁾	MAX. RATED POWER <i>BC</i> _{85 °C} W	TOLERANCE ⁽²⁾ \pm %	TEMPERATURE COEFFICIENT \pm ppm/°C	E-SERIES OHMIC VALUES
ISOA	0.47 to 3	120	10, 5	300	E24
	3 to 220	120	10, 5	150	
	220 to 1M	120	10, 5	100	

Notes

- ⁽¹⁾ Minimum value down to 0R1 available on request
⁽²⁾ \pm 2 % or \pm 1 % on special request for limited resistance value and with reduction of maximum power and pulse rating (contact us for details)

MECHANICAL SPECIFICATIONS	
UL 94 flame classifications	Housing and potting materials comply with UL 94 V-0 standard
Resistive element	Cermet
Substrate	Alumina
Encapsulation	Resin filled case

TECHNICAL SPECIFICATIONS	
PARAMETER	ISOA
Nominal power at 85 °C bottom case temperature	120 W
Operating temperature range	-55 °C to +150 °C
Maximum operating voltage	1500 V
Dielectric strength with all terminals connected as one pole	4000 V _{RMS} (50 Hz / 1 min)
Dielectric strength power resistor to NTC resistor	1500 V _{RMS} (50 Hz / 1 min)
CTI	> 600
Creepage distance	> 4.2 mm
Clearance distance	> 3.6 mm
Insulation	\geq 10 G Ω at 1000 V _{DC}
Inductance	\leq 50 nH
NTC characteristics (option)	Vishay NTCS0603E3103FLT Vishay NTC is AEC-Q200 qualified Temperature cycling test -55 °C / +150 °C "Resistance Value vs. Temperature" curve, see below
Weight (max.)	< 16 g



PERFORMANCES (AEC-Q200 Revision D Qualification Type Tests)		
TESTS	CONDITIONS	REQUIREMENTS
High temperature exposure	MIL-STD-202 method 108 Condition: 1000 h at T = 155 °C. Unpowered	$\leq \pm (2 \% + 0.1 \Omega)$
Temperature cycling	JESD22 method JA-104 1000 cycles (-55 °C to +125 °C)	$\leq \pm (2 \% + 0.1 \Omega)$
Biased humidity	MIL-STD-202 method 103 Condition: 1000 h 85 °C / 85 % RH, 10 % of operating power 10 W	$\leq \pm (5 \% + 0.1 \Omega)$
Operational life	MIL-STD-202 method 108 Condition: D steady state $T_A = 85 \text{ °C}$ of bottom case at rated power 120 W 90' On / 30' off / 1000 h	$\leq \pm (2 \% + 0.1 \Omega)$
ESD	AEC-Q200-002 Condition: 6 kV to 25 kV	$\leq \pm (0.5 \% + 0.05 \Omega)$
Vibration	MIL-STD-202 method 204 Condition B: 10 g's for 20 min for 1 cycle, 12 cycles each of 3 orientations (total of 36). Test from 10 Hz to 2000 Hz	$\leq \pm (0.5 \% + 0.05 \Omega)$
Mechanical shock	MIL-STD-202 method 213 Fig. 1 Condition C: 100 g's/6 ms 3.75 m/s 3 shock/direction, 2 directions along 3 axes (18 shocks)	$\leq \pm (0.5 \% + 0.05 \Omega)$
Terminal strength (lead)	MIL-STD-202 method 211 Test leaded device lead integrity only. Conditions: A (2.27 kg)	$\leq \pm (0.5 \% + 0.05 \Omega)$

Note

- All tests were done in Vishay MCB laboratories conditions

RESISTANCE VALUE VS. TEMPERATURE FOR NTC0603E3103FLT

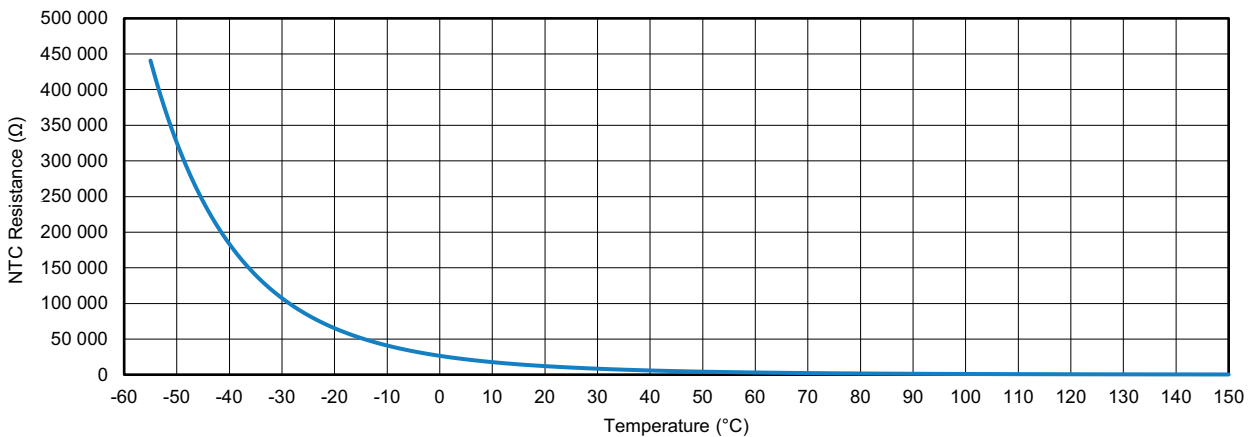



POWER DISSIPATION

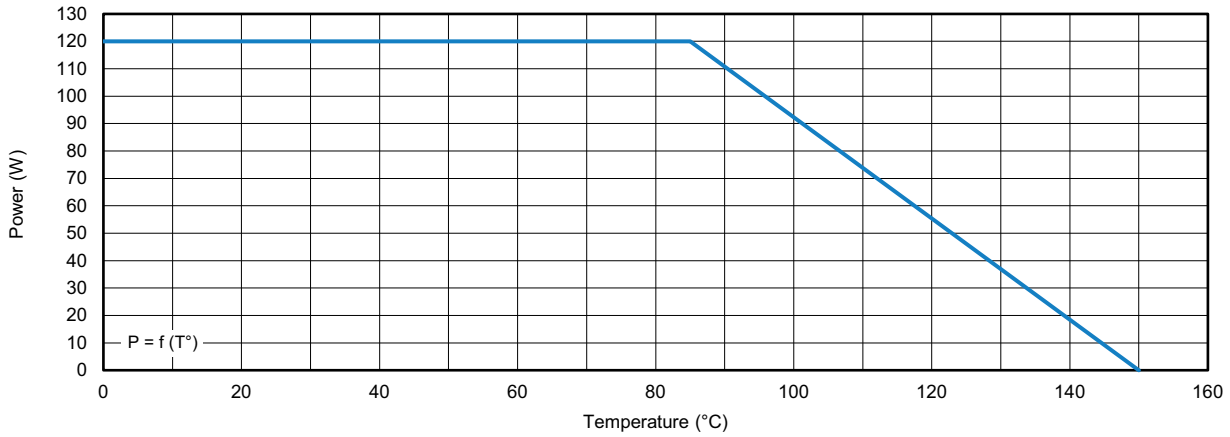

Permanent applicable power (W) as a function of bottom case temperature (°C)

PULSE ENERGY

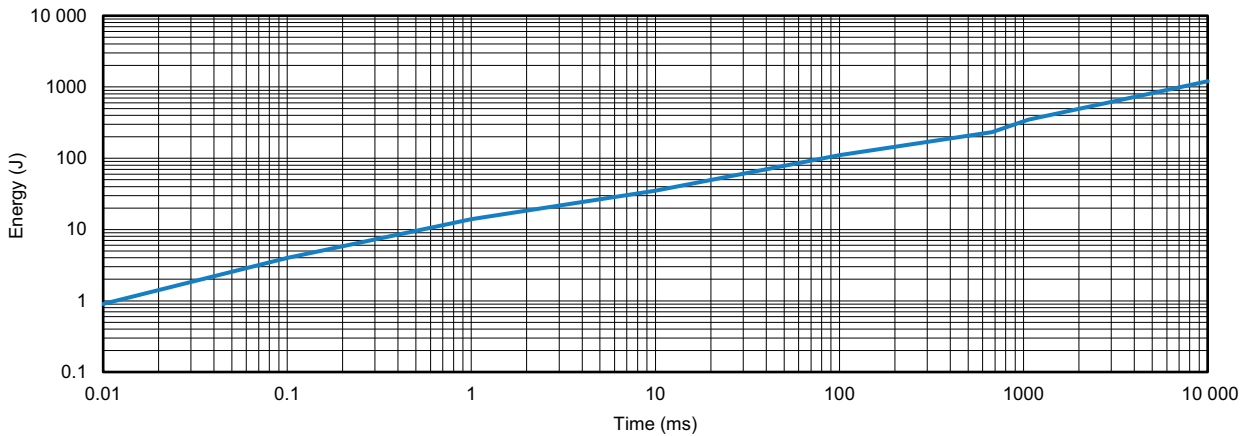

POWER VS. TIME

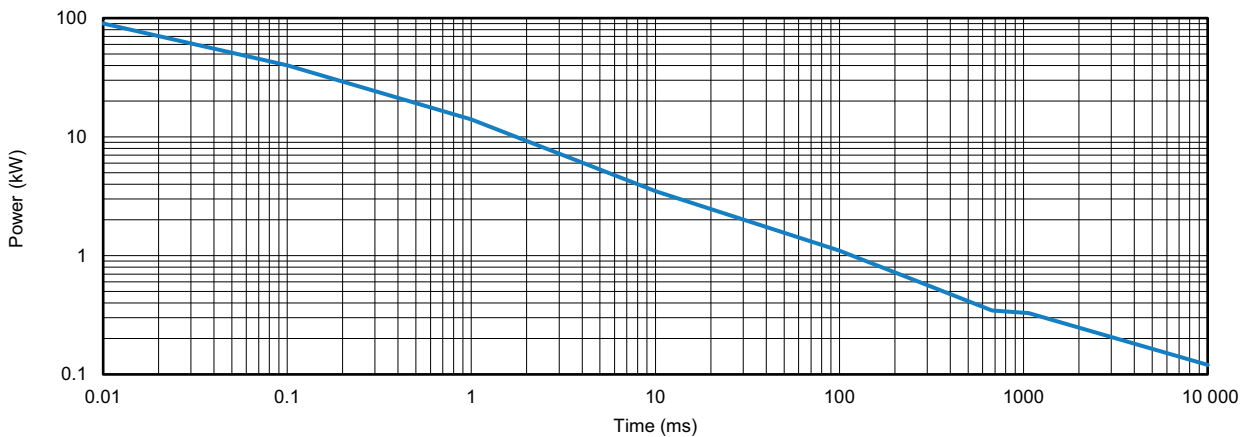

DIMENSIONS in millimeters

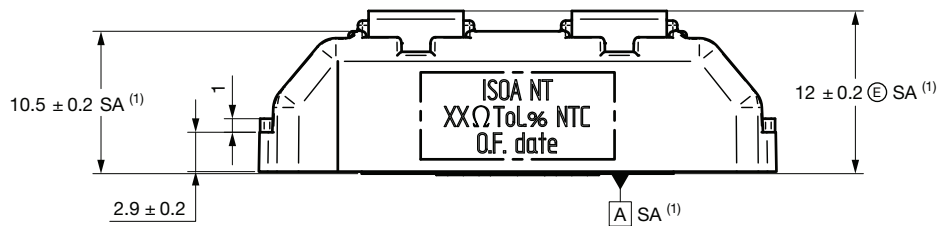
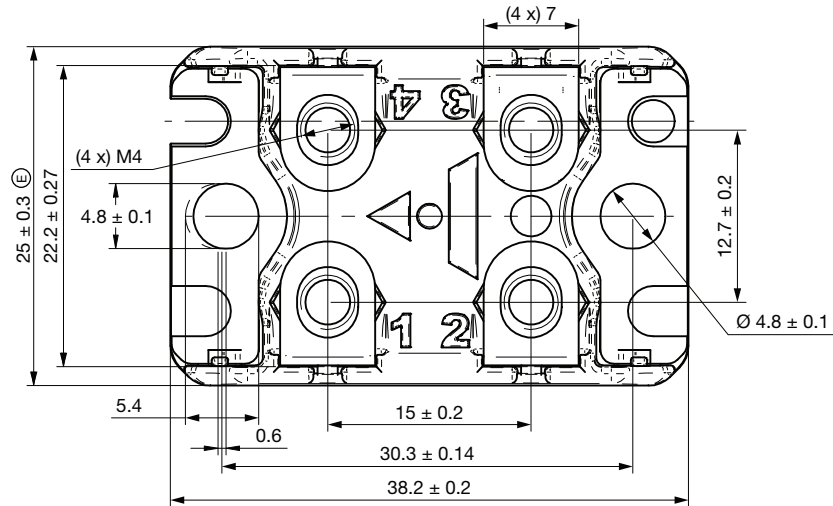

Note

(1) SA: under alumina

INTERNAL CONFIGURATION

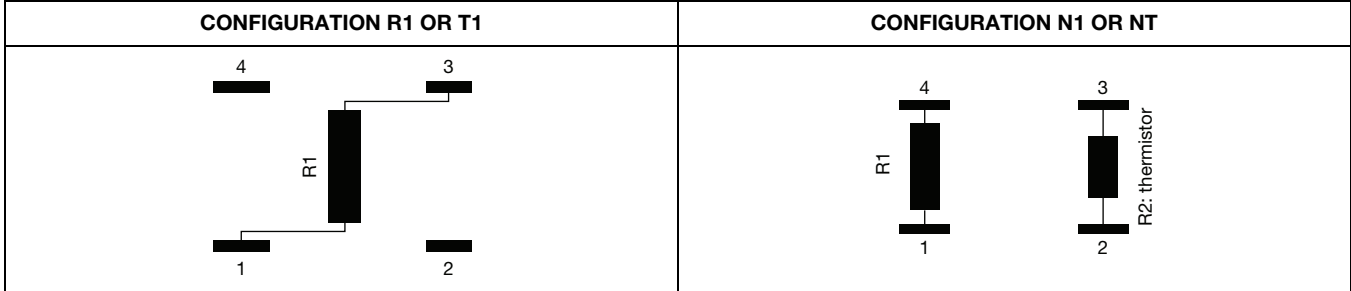

ASSEMBLY

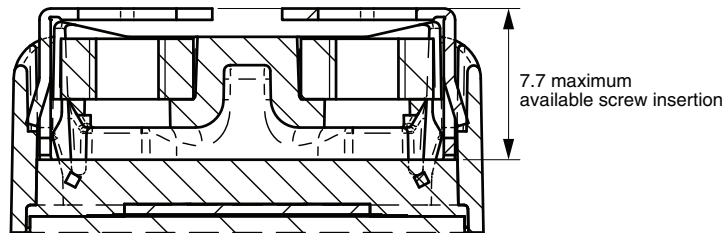

Tightening torque for mechanical fixation	1.8 Nm ± 0.2 Nm
Tightening torque for electrical connections	1.3 Nm ± 0.2 Nm



STORAGE CONDITIONS

Parts shall be stored in a dry place from 0 °C to +40 °C at 80 % RH maximum.

COOLING

The temperature of the heatsink may be maintained at the specified values with:

- Forced air ventilation or internal circulation of a liquid cooling
- Heatsink contact surface: < Ra 6.3 μ
- Evenness defect: 0.05 mm / 50 mm and 0.025 mm / 25 mm
- Surface temperature gradient (isotherm): 20 °C max.
- Thermal compound not supplied (resistance < 0.025 °C / W / 0.05 mm preconized)
- For mounting recommendations please see application notes www.vishay.com/doc?32600 (without PC-TIM option) or www.vishay.com/doc?32601 (with PC-TIM option)

Note

- The user must select the thermal resistance of the heatsink according to the power applied

ORDERING INFORMATION						
ISOA	100	R1	1301	5 %	XXX	TU10
MODEL	STYLE	CONFIGURATION	RESISTANCE VALUE	TOLERANCE	CUSTOM DESIGN	PACKAGING
		Single resistor or Resistor and NTC		± 5 % ± 10 % Other on request		

GLOBAL PART NUMBER INFORMATION																	
I	S	O	A	1	0	0	R	1	1	3	0	1	J	T	X	X	X
1				2			3	4				5	6	7			
1	2	3			4			5	6	7							
TYPE	POWER	OPTIONS			OHMIC VALUE			TOLERANCE	PACKAGING	INDUSTRIALIZATION NUMBER							
ISOA	100 = 120 W	R1: 1 resistor only N1: 1 resistor and NTC T1: 1 resistor and TIM NT: 1 resistor and NTC, and TIM			The first three digits are significant figures and the last specifies the number of zeros to follow, R designates decimal point. 1301 = 1300 Ω			J = 5 % K = 10 %	T = tube 10 pieces	3 specific digits (if applicable)							



Disclaimer

ALL PRODUCT, PRODUCT SPECIFICATIONS AND DATA ARE SUBJECT TO CHANGE WITHOUT NOTICE TO IMPROVE RELIABILITY, FUNCTION OR DESIGN OR OTHERWISE.

Vishay Intertechnology, Inc., its affiliates, agents, and employees, and all persons acting on its or their behalf (collectively, "Vishay"), disclaim any and all liability for any errors, inaccuracies or incompleteness contained in any datasheet or in any other disclosure relating to any product.

Vishay makes no warranty, representation or guarantee regarding the suitability of the products for any particular purpose or the continuing production of any product. To the maximum extent permitted by applicable law, Vishay disclaims (i) any and all liability arising out of the application or use of any product, (ii) any and all liability, including without limitation special, consequential or incidental damages, and (iii) any and all implied warranties, including warranties of fitness for particular purpose, non-infringement and merchantability.

Statements regarding the suitability of products for certain types of applications are based on Vishay's knowledge of typical requirements that are often placed on Vishay products in generic applications. Such statements are not binding statements about the suitability of products for a particular application. It is the customer's responsibility to validate that a particular product with the properties described in the product specification is suitable for use in a particular application. Parameters provided in datasheets and / or specifications may vary in different applications and performance may vary over time. All operating parameters, including typical parameters, must be validated for each customer application by the customer's technical experts. Product specifications do not expand or otherwise modify Vishay's terms and conditions of purchase, including but not limited to the warranty expressed therein.

Hyperlinks included in this datasheet may direct users to third-party websites. These links are provided as a convenience and for informational purposes only. Inclusion of these hyperlinks does not constitute an endorsement or an approval by Vishay of any of the products, services or opinions of the corporation, organization or individual associated with the third-party website. Vishay disclaims any and all liability and bears no responsibility for the accuracy, legality or content of the third-party website or for that of subsequent links.

Vishay products are not designed for use in life-saving or life-sustaining applications or any application in which the failure of the Vishay product could result in personal injury or death unless specifically qualified in writing by Vishay. Customers using or selling Vishay products not expressly indicated for use in such applications do so at their own risk. Please contact authorized Vishay personnel to obtain written terms and conditions regarding products designed for such applications.

No license, express or implied, by estoppel or otherwise, to any intellectual property rights is granted by this document or by any conduct of Vishay. Product names and markings noted herein may be trademarks of their respective owners.