

## Surface Mount Multilayer Ceramic Chip Capacitors for Automotive High Frequency Applications



**RoHS**  
COMPLIANT

HALOGEN  
**FREE**

**GREEN**  
(5-2008)

### FEATURES

- Case size 0402, 0603, 0805, 0505, 1111, 1206
- High frequency
- AEC-Q200 qualified with PPAP available
- Ultra-stable dielectric material
- Lead (Pb)-free terminations code "X" (GA....31M) for soldering assembly
- Lead (Pb)-free AgPd finish termination code "E" (GA....34G) for conductive epoxy assembly
- Surface mount, wet build process
- Reliable Noble Metal Electrode (NME) system
- Made with a combination of design, materials and tight process control to achieve very high field reliability
- Material categorization: for definitions of compliance please see [www.vishay.com/doc?99912](http://www.vishay.com/doc?99912)

### LINKS TO ADDITIONAL RESOURCES



#### Note

- Models as per VJ HIFREQ Series, applicable for this GA Series

### ELECTRICAL SPECIFICATIONS

#### Note

- Electrical characteristics at 25 °C unless otherwise specified

**Operating Temperature:** -55 °C to +150 °C

#### Capacitance Range:

0402: 0.1 pF to 82 pF

0603: 0.1 pF to 470 pF

0805: 0.1 pF to 1.0 nF

0505: 0.1 pF to 1.0 nF

1111: 0.2 pF to 3.3 nF

1206: 1.0 pF to 82 pF

**Voltage Rating:** 25 V<sub>DC</sub> to 1500 V<sub>DC</sub>

#### Temperature Coefficient of Capacitance (TCC):

C0G (D): 0 ppm/°C ± 30 ppm/°C from -55 °C to +150 °C with zero (0) V<sub>DC</sub> applied

#### Dissipation Factor (DF):

C0G (D): 0.05 % max. at 1.0 V<sub>RMS</sub> and 1 MHz for values ≤ 1000 pF

C0G (D): 0.05 % max. at 1.0 V<sub>RMS</sub> and 1 kHz for values > 1000 pF

### APPLICATIONS

- Navigation / infotainment
- GPS
- TPMS
- ADAS
- Telematics
- Autonomous cars

**Aging Rate:** 0 % maximum per decade

#### Insulation Resistance (IR):

at +25 °C and rated voltage 100 000 MΩ minimum or 1000 ΩF, whichever is less

at +125 °C and rated voltage 10 000 MΩ minimum or 100 ΩF, whichever is less

#### Dielectric Strength Test:

performed per method 103 of EIA-198-2-E.

Applied test voltages:

≤ 200 V<sub>DC</sub>-rated: min. 250 % of rated voltage

200 V<sub>DC</sub>-rated: min. 200 % of rated voltage

300 V<sub>DC</sub> to 1000 V<sub>DC</sub>-rated: min. 150 % of rated voltage

1500 V<sub>DC</sub>-rated: 120 % of rated voltage



QUICK REFERENCE DATA				
DIELECTRIC	CASE	MAXIMUM VOLTAGE (V)	CAPACITANCE	
			MINIMUM	MAXIMUM
D = HIFREQ	0402	200	0.1 pF	82 pF
	0603	250	0.1 pF	470 pF
	0805	500	0.1 pF	1.0 nF
	0505	250	0.1 pF	1.0 nF
	1111	1500	0.2 pF	3.3 nF
	1206	630	1.0 pF	82 pF

ORDERING INFORMATION								
GA0603	D	1R0	B	X	B	A	C	31M
CASE CODE	DIELECTRIC	CAPACITANCE NOMINAL CODE	CAPACITANCE TOLERANCE	TERMINATION	DC VOLTAGE RATING <sup>(1)</sup>	MARKING	PACKAGING	PROCESS CODE
0402 0603 0805 0505 1111 1206	D = HIFREQ	Expressed in picofarads (pF). The first two digits are significant, the third is a multiplier. An "R" indicates a decimal point. <b>Example:</b> 1R0 = 1.0 pF	V = ± 0.05 pF B = ± 0.10 pF C = ± 0.25 pF D = ± 0.50 pF F = ± 1 % G = ± 2 % J = ± 5 % K = ± 10 % M = ± 20 %  <b>Note</b> Details see "Selection Chart"	E = AgPd <sup>(2)</sup> X = Ni barrier 100 % tin plate matte finish	X = 25 V A = 50 V B = 100 V K = 150 V C = 200 V P = 250 V D = 300 V E = 500 V L = 630 V G = 1000 V R = 1500 V	A = no marking	T = 7" reel / plastic tape C = 7" reel / paper tape O = 7" reel / flamed paper tape J = 7" reel (low quantity) R = 11 1/4" / 13" reel / plastic tape P = 11 1/4" / 13" reel / paper tape I = 11 1/4" / 13" reel / flamed paper tape  <b>Note</b> "I" and "O" is used for "E" termination code	31M = "Green" automotive HIFREQ Ni barrier termination 34G = "Green" automotive HIFREQ AgPd termination

**Notes**

- (1) DC voltage rating should not be exceeded in application
- (2) AgPd termination code "E" available for silver epoxy bonding

ENVIRONMENTAL STATUS			
TERMINATION CODE	TERMINATION DESCRIPTION	RoHS COMPLIANT	VISHAY GREEN
X	Ni barrier 100 % tin plated matte finish	Yes	Yes
E	AgPd	Yes	Yes



**DIMENSIONS** in inches (millimeters)

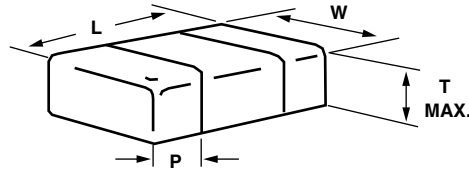

CASE CODE	STYLE	LENGTH (L)	WIDTH (W)	MAXIMUM THICKNESS (T)	TERMINATIONS PAD (P)	
					MINIMUM	MAXIMUM
0402	GA0402	0.040 ± 0.004 (1.02 ± 0.10)	0.020 ± 0.004 (0.51 ± 0.10)	0.024 (0.61)	0.004 (0.10)	0.016 (0.41)
0603	GA0603	0.063 ± 0.006 (1.60 ± 0.15)	0.031 ± 0.005 (0.80 ± 0.12)	0.037 (0.94)	0.010 (0.25)	0.022 (0.55)
0805	GA0805	0.079 ± 0.008 (2.00 ± 0.20)	0.049 ± 0.008 (1.25 ± 0.20)	0.057 (1.45)	0.010 (0.25)	0.030 (0.76)
0505	GA0505	0.055 + 0.015 / - 0.010 (1.40 + 0.382 / - 0.254)	0.055 ± 0.015 (1.40 ± 0.38)	0.057 (1.45)	0.004 (0.10)	0.016 (0.41)
1111	GA1111	0.117 + 0.015 / - 0.010 (2.98 + 0.382 / - 0.254)	0.110 + 0.015 / - 0.020 (2.79 + 0.382 / - 0.509)	0.102 (2.59)	0.012 (0.30)	0.018 (0.46)
1206	GA1206	0.126 ± 0.010 (3.20 ± 0.25)	0.063 ± 0.010 (1.60 ± 0.25)	0.067 (1.70)	0.010 (0.25)	0.028 (0.71)



SELECTION CHART						
DIELECTRIC (VISHAY CODE)		COG (D)				
STYLE		GA0402				
CASE CODE		0402				
VOLTAGE (V <sub>DC</sub> )		25	50	100	200	TOLERANCE
VOLTAGE CODE		X	A	B	C	
CAP. CODE	CAP.					
0R1	0.1 pF	••	••	••	••	V, B, C, D
0R2	0.2 pF	••	••	••	••	V, B, C, D
0R3	0.3 pF	••	••	••	••	V, B, C, D
0R4	0.4 pF	••	••	••	••	V, B, C, D
0R5	0.5 pF	••	••	••	••	V, B, C, D
0R6	0.6 pF	••	••	••	••	V, B, C, D
0R7	0.7 pF	••	••	••	••	V, B, C, D
0R8	0.8 pF	••	••	••	••	V, B, C, D
0R9	0.9 pF	••	••	••	••	V, B, C, D
1R0	1.0 pF	••	••	••	••	V, B, C, D
1R1	1.1 pF	••	••	••	••	V, B, C, D
1R2	1.2 pF	••	••	••	••	V, B, C, D
1R3	1.3 pF	••	••	••	••	V, B, C, D
1R4	1.4 pF	••	••	••	••	V, B, C, D
1R5	1.5 pF	••	••	••	••	V, B, C, D
1R6	1.6 pF	••	••	••	••	V, B, C, D
1R7	1.7 pF	••	••	••	••	V, B, C, D
1R8	1.8 pF	••	••	••	••	V, B, C, D
1R9	1.9 pF	••	••	••	••	V, B, C, D
2R0	2.0 pF	••	••	••	••	V, B, C, D
2R1	2.1 pF	••	••	••	••	V, B, C, D
2R2	2.2 pF	••	••	••	••	V, B, C, D
2R4	2.4 pF	••	••	••	••	V, B, C, D
2R7	2.7 pF	••	••	••	••	V, B, C, D
3R0	3.0 pF	••	••	••	••	V, B, C, D
3R3	3.3 pF	••	••	••	••	V, B, C, D
3R6	3.6 pF	••	••	••	••	V, B, C, D
3R9	3.9 pF	••	••	••	••	V, B, C, D
4R3	4.3 pF	••	••	••	••	V, B, C, D
4R7	4.7 pF	••	••	••	••	V, B, C, D
5R1	5.1 pF	••	••	••	••	V, B, C, D
5R6	5.6 pF	••	••	••	••	V, B, C, D
6R2	6.2 pF	••	••	••	••	V, B, C, D
6R8	6.8 pF	••	••	••	••	V, B, C, D
7R5	7.5 pF	••	••	••	••	V, B, C, D
8R2	8.2 pF	••	••	••	••	V, B, C, D
9R1	9.1 pF	••	••	••	••	V, B, C, D
100	10 pF	••	••	••	••	V, F, G, J, K, M
110	11 pF	••	••	••	••	F, G, J, K, M
120	12 pF	••	••	••	••	F, G, J, K, M
130	13 pF	••	••	••	••	F, G, J, K, M
150	15 pF	••	••	••	••	F, G, J, K, M
180	18 pF	••	••	••	••	F, G, J, K, M
200	20 pF	••	••	••	••	F, G, J, K, M
220	22 pF	••	••	••	••	F, G, J, K, M
240	24 pF	••	••	••	••	F, G, J, K, M
270	27 pF	••	••	••	••	F, G, J, K, M
300	30 pF	••	••	••	••	F, G, J, K, M
330	33 pF	••	••	••	••	F, G, J, K, M
360	36 pF	••	••	••	••	F, G, J, K, M
390	39 pF	••	••	••	••	F, G, J, K, M
430	43 pF	••	••	••	••	F, G, J, K, M
470	47 pF	••	••	••	••	F, G, J, K, M
510	51 pF	••	••	••	••	F, G, J, K, M
560	56 pF	••	••	••	••	F, G, J, K, M
620	62 pF	••	••	••	••	F, G, J, K, M
680	68 pF	••	••	••	••	F, G, J, K, M
750	75 pF	••	••	••	••	F, G, J, K, M
820	82 pF	••	••	••	••	F, G, J, K, M
910	91 pF	••	••	••	••	F, G, J, K, M
101	100 pF					
111	110 pF					
121	120 pF					

Note  
 •• Paper carrier



SELECTION CHART							
DIELECTRIC (VISHAY CODE)		COG (D)					
STYLE		GA0603					
CASE CODE		0603					
VOLTAGE (V <sub>DC</sub> )		25	50	100	200	250	TOLERANCE
VOLTAGE CODE		X	A	B	C	P	
CAP. CODE	CAP.						
0R1	0.1 pF	••	••	••	••	••	V, B, C, D
0R2	0.2 pF	••	••	••	••	••	V, B, C, D
0R3	0.3 pF	••	••	••	••	••	V, B, C, D
0R4	0.4 pF	••	••	••	••	••	V, B, C, D
0R5	0.5 pF	••	••	••	••	••	V, B, C, D
0R6	0.6 pF	••	••	••	••	••	V, B, C, D
0R7	0.7 pF	••	••	••	••	••	V, B, C, D
0R8	0.8 pF	••	••	••	••	••	V, B, C, D
0R9	0.9 pF	••	••	••	••	••	V, B, C, D
1R0	1.0 pF	••	••	••	••	••	V, B, C, D
1R1	1.1 pF	••	••	••	••	••	V, B, C, D
1R2	1.2 pF	••	••	••	••	••	V, B, C, D
1R3	1.3 pF	••	••	••	••	••	V, B, C, D
1R4	1.4 pF	••	••	••	••	••	V, B, C, D
1R5	1.5 pF	••	••	••	••	••	V, B, C, D
1R6	1.6 pF	••	••	••	••	••	V, B, C, D
1R7	1.7 pF	••	••	••	••	••	V, B, C, D
1R8	1.8 pF	••	••	••	••	••	V, B, C, D
1R9	1.9 pF	••	••	••	••	••	V, B, C, D
2R0	2.0 pF	••	••	••	••	••	V, B, C, D
2R1	2.1 pF	••	••	••	••	••	V, B, C, D
2R2	2.2 pF	••	••	••	••	••	V, B, C, D
2R4	2.4 pF	••	••	••	••	••	V, B, C, D
2R7	2.7 pF	••	••	••	••	••	V, B, C, D
3R0	3.0 pF	••	••	••	••	••	V, B, C, D
3R3	3.3 pF	••	••	••	••	••	V, B, C, D
3R6	3.6 pF	••	••	••	••	••	V, B, C, D
3R9	3.9 pF	••	••	••	••	••	V, B, C, D
4R3	4.3 pF	••	••	••	••	••	V, B, C, D
4R7	4.7 pF	••	••	••	••	••	V, B, C, D
5R1	5.1 pF	••	••	••	••	••	V, B, C, D
5R6	5.6 pF	••	••	••	••	••	V, B, C, D
6R2	6.2 pF	••	••	••	••	••	V, B, C, D
6R8	6.8 pF	••	••	••	••	••	V, B, C, D
7R5	7.5 pF	••	••	••	••	••	V, B, C, D
8R2	8.2 pF	••	••	••	••	••	V, B, C, D
9R1	9.1 pF	••	••	••	••	••	V, B, C, D
100	10 pF	••	••	••	••	••	V, F, G, J, K, M
110	11 pF	••	••	••	••	••	F, G, J, K, M
120	12 pF	••	••	••	••	••	F, G, J, K, M
130	13 pF	••	••	••	••	••	F, G, J, K, M
150	15 pF	••	••	••	••	••	F, G, J, K, M
180	18 pF	••	••	••	••	••	F, G, J, K, M
200	20 pF	••	••	••	••	••	F, G, J, K, M
220	22 pF	••	••	••	••	••	F, G, J, K, M
240	24 pF	••	••	••	••	••	F, G, J, K, M
270	27 pF	••	••	••	••	••	F, G, J, K, M
300	30 pF	••	••	••	••	••	F, G, J, K, M
330	33 pF	••	••	••	••	••	F, G, J, K, M
360	36 pF	••	••	••	••	••	F, G, J, K, M
390	39 pF	••	••	••	••	••	F, G, J, K, M
430	43 pF	••	••	••	••	••	F, G, J, K, M
470	47 pF	••	••	••	••	••	F, G, J, K, M
510	51 pF	••	••	••	••	••	F, G, J, K, M
560	56 pF	••	••	••	••	••	F, G, J, K, M
620	62 pF	•	•	•	•	•	F, G, J, K, M
680	68 pF	•	•	•	•	•	F, G, J, K, M
750	75 pF	•	•	•	•	•	F, G, J, K, M
820	82 pF	•	•	•	•	•	F, G, J, K, M
910	91 pF	•	•	•	•	•	F, G, J, K, M

**Note**

- Paper carrier • Plastic carrier tape



SELECTION CHART							
DIELECTRIC (VISHAY CODE)		COG (D)					
STYLE		GA0603					
CASE CODE		0603					
VOLTAGE (V <sub>DC</sub> )		25	50	100	200	250	TOLERANCE
VOLTAGE CODE		X	A	B	C	P	
CAP. CODE	CAP.						
101	100 pF	•	•	•	•	•	F, G, J, K, M
111	110 pF	•	•	•			F, G, J, K, M
121	120 pF	•	•	•			F, G, J, K, M
131	130 pF	•	•	•			F, G, J, K, M
151	150 pF	•	•	•			F, G, J, K, M
181	180 pF	•	•				F, G, J, K, M
201	200 pF	•	•				F, G, J, K, M
221	220 pF	•	•				F, G, J, K, M
241	240 pF	•	•				F, G, J, K, M
271	270 pF	•	•				F, G, J, K, M
301	300 pF	•	•				F, G, J, K, M
331	330 pF	•	•				F, G, J, K, M
361	360 pF	•					F, G, J, K, M
391	390 pF	•					F, G, J, K, M
431	430 pF	•					F, G, J, K, M
471	470 pF	•					F, G, J, K, M
511	510 pF						
561	560 pF						
621	620 pF						
681	680 pF						
751	750 pF						
821	820 pF						
911	910 pF						
102	1.0 nF						
112	1.1 nF						
122	1.2 nF						
132	1.3 nF						
152	1.5 nF						
182	1.8 nF						

**Note**

- Paper carrier • Plastic carrier tape



SELECTION CHART								
DIELECTRIC (VISHAY CODE)		COG (D)						
STYLE		GA0805						
CASE CODE		0805						
VOLTAGE (V <sub>DC</sub> )		25	50	100	200	250	500 <sup>(1)</sup>	TOLERANCE
VOLTAGE CODE		X	A	B	C	P	E	
CAP. CODE	CAP.							
0R1	0.1 pF	•	•	•	•	•		V, B, C, D
0R2	0.2 pF	•	•	•	•	•		V, B, C, D
0R3	0.3 pF	•	•	•	•	•		V, B, C, D
0R4	0.4 pF	•	•	•	•	•		V, B, C, D
0R5	0.5 pF	•	•	•	•	•		V, B, C, D
0R6	0.6 pF	•	•	•	•	•		V, B, C, D
0R7	0.7 pF	•	•	•	•	•		V, B, C, D
0R8	0.8 pF	•	•	•	•	•		V, B, C, D
0R9	0.9 pF	•	•	•	•	•		V, B, C, D
1R0	1.0 pF	•	•	•	•	•	•	V, B, C, D
1R1	1.1 pF	•	•	•	•	•		V, B, C, D
1R2	1.2 pF	•	•	•	•	•	•	V, B, C, D
1R3	1.3 pF	•	•	•	•	•		V, B, C, D
1R4	1.4 pF	•	•	•	•	•		V, B, C, D
1R5	1.5 pF	•	•	•	•	•	•	V, B, C, D
1R6	1.6 pF	•	•	•	•	•		V, B, C, D
1R7	1.7 pF	•	•	•	•	•		V, B, C, D
1R8	1.8 pF	•	•	•	•	•	•	V, B, C, D
1R9	1.9 pF	•	•	•	•	•		V, B, C, D
2R0	2.0 pF	•	•	•	•	•		V, B, C, D
2R1	2.1 pF	•	•	•	•	•		V, B, C, D
2R2	2.2 pF	•	•	•	•	•	•	V, B, C, D
2R4	2.4 pF	•	•	•	•	•		V, B, C, D
2R7	2.7 pF	•	•	•	•	•	•	V, B, C, D
3R0	3.0 pF	•	•	•	•	•		V, B, C, D
3R3	3.3 pF	•	•	•	•	•	•	V, B, C, D
3R6	3.6 pF	•	•	•	•	•		V, B, C, D
3R9	3.9 pF	•	•	•	•	•	•	V, B, C, D
4R3	4.3 pF	•	•	•	•	•		V, B, C, D
4R7	4.7 pF	•	•	•	•	•	•	V, B, C, D
5R1	5.1 pF	•	•	•	•	•		V, B, C, D
5R6	5.6 pF	•	•	•	•	•	•	V, B, C, D
6R2	6.2 pF	•	•	•	•	•		V, B, C, D
6R8	6.8 pF	•	•	•	•	•	•	V, B, C, D
7R5	7.5 pF	•	•	•	•	•		V, B, C, D
8R2	8.2 pF	•	•	•	•	•	•	V, B, C, D
9R1	9.1 pF	•	•	•	•	•		V, B, C, D

**Notes**

- Plastic carrier tape
- <sup>(1)</sup> 500 V only in tolerance B, C, D



SELECTION CHART								
DIELECTRIC (VISHAY CODE)		COG (D)						
STYLE		GA0805						
CASE CODE		0805						
VOLTAGE (V <sub>DC</sub> )		25	50	100	200	250	500 <sup>(1)</sup>	TOLERANCE
VOLTAGE CODE		X	A	B	C	P	E	
CAP. CODE	CAP.							
100	10 pF	•	•	•	•	•	•	V, F, G, J, K, M
110	11 pF	•	•	•	•	•	•	F, G, J, K, M
120	12 pF	•	•	•	•	•	•	F, G, J, K, M
130	13 pF	•	•	•	•	•	•	F, G, J, K, M
150	15 pF	•	•	•	•	•	•	F, G, J, K, M
180	18 pF	•	•	•	•	•	•	F, G, J, K, M
200	20 pF	•	•	•	•	•	•	F, G, J, K, M
220	22 pF	•	•	•	•	•	•	F, G, J, K, M
240	24 pF	•	•	•	•	•	•	F, G, J, K, M
270	27 pF	•	•	•	•	•	•	F, G, J, K, M
300	30 pF	•	•	•	•	•	•	F, G, J, K, M
330	33 pF	•	•	•	•	•	•	F, G, J, K, M
360	36 pF	•	•	•	•	•	•	F, G, J, K, M
390	39 pF	•	•	•	•	•	•	F, G, J, K, M
430	43 pF	•	•	•	•	•	•	F, G, J, K, M
470	47 pF	•	•	•	•	•	•	F, G, J, K, M
510	51 pF	•	•	•	•	•	•	F, G, J, K, M
560	56 pF	•	•	•	•	•	•	F, G, J, K, M
620	62 pF	•	•	•	•	•	•	F, G, J, K, M
680	68 pF	•	•	•	•	•	•	F, G, J, K, M
750	75 pF	•	•	•	•	•	•	F, G, J, K, M
820	82 pF	•	•	•	•	•	•	F, G, J, K, M
910	91 pF	•	•	•	•	•	•	F, G, J, K, M
101	100 pF	•	•	•	•	•	•	F, G, J, K, M
111	110 pF	•	•	•	•	•	•	F, G, J, K, M
121	120 pF	•	•	•	•	•	•	F, G, J, K, M
131	130 pF	•	•	•	•	•	•	F, G, J, K, M
151	150 pF	•	•	•	•	•	•	F, G, J, K, M
181	180 pF	•	•	•	•	•	•	F, G, J, K, M
201	200 pF	•	•	•	•	•	•	F, G, J, K, M
221	220 pF	•	•	•	•	•	•	F, G, J, K, M
241	240 pF	•	•	•	•	•	•	F, G, J, K, M
271	270 pF	•	•	•	•	•	•	F, G, J, K, M
301	300 pF	•	•	•	•	•	•	F, G, J, K, M
331	330 pF	•	•	•	•	•	•	F, G, J, K, M
361	360 pF	•	•	•	•	•	•	F, G, J, K, M
391	390 pF	•	•	•	•	•	•	F, G, J, K, M
431	430 pF	•	•	•	•	•	•	F, G, J, K, M
471	470 pF	•	•	•	•	•	•	F, G, J, K, M
511	510 pF	•	•	•	•	•	•	F, G, J, K, M
561	560 pF	•	•	•	•	•	•	F, G, J, K, M
621	620 pF	•	•	•	•	•	•	F, G, J, K, M
681	680 pF	•	•	•	•	•	•	F, G, J, K, M
751	750 pF	•	•	•	•	•	•	F, G, J, K, M
821	820 pF	•	•	•	•	•	•	F, G, J, K, M
911	910 pF	•	•	•	•	•	•	F, G, J, K, M
102	1.0 nF	•	•	•	•	•	•	F, G, J, K, M
112	1.1 nF	•	•	•	•	•	•	F, G, J, K, M
122	1.2 nF	•	•	•	•	•	•	F, G, J, K, M
132	1.3 nF	•	•	•	•	•	•	F, G, J, K, M
152	1.5 nF	•	•	•	•	•	•	F, G, J, K, M
182	1.8 nF	•	•	•	•	•	•	F, G, J, K, M

**Notes**

- Plastic carrier tape
- <sup>(1)</sup> 500 V only in tolerance F, G, J, K





SELECTION CHART							
DIELECTRIC (VISHAY CODE)		COG (D)					
STYLE		GA0505					
CASE CODE		0505					
VOLTAGE (V <sub>DC</sub> )		50	100	150	200	250	TOLERANCE
VOLTAGE CODE		A	B	K	C	P	
CAP. CODE	CAP.						
0R1	0.1 pF	•	•	•	•	•	V, B, C, D
0R2	0.2 pF	•	•	•	•	•	V, B, C, D
0R3	0.3 pF	•	•	•	•	•	V, B, C, D
0R4	0.4 pF	•	•	•	•	•	V, B, C, D
0R5	0.5 pF	•	•	•	•	•	V, B, C, D
0R6	0.6 pF	•	•	•	•	•	V, B, C, D
0R7	0.7 pF	•	•	•	•	•	V, B, C, D
0R8	0.8 pF	•	•	•	•	•	V, B, C, D
0R9	0.9 pF	•	•	•	•	•	V, B, C, D
1R0	1.0 pF	•	•	•	•	•	V, B, C, D
1R1	1.1 pF	•	•	•	•	•	V, B, C, D
1R2	1.2 pF	•	•	•	•	•	V, B, C, D
1R3	1.3 pF	•	•	•	•	•	V, B, C, D
1R4	1.4 pF	•	•	•	•	•	V, B, C, D
1R5	1.5 pF	•	•	•	•	•	V, B, C, D
1R6	1.6 pF	•	•	•	•	•	V, B, C, D
1R7	1.7 pF	•	•	•	•	•	V, B, C, D
1R8	1.8 pF	•	•	•	•	•	V, B, C, D
1R9	1.9 pF	•	•	•	•	•	V, B, C, D
2R0	2.0 pF	•	•	•	•	•	V, B, C, D
2R1	2.1 pF	•	•	•	•	•	V, B, C, D
2R2	2.2 pF	•	•	•	•	•	V, B, C, D
2R4	2.4 pF	•	•	•	•	•	V, B, C, D
2R7	2.7 pF	•	•	•	•	•	V, B, C, D
3R0	3.0 pF	•	•	•	•	•	V, B, C, D
3R3	3.3 pF	•	•	•	•	•	V, B, C, D
3R6	3.6 pF	•	•	•	•	•	V, B, C, D
3R9	3.9 pF	•	•	•	•	•	V, B, C, D
4R3	4.3 pF	•	•	•	•	•	V, B, C, D
4R7	4.7 pF	•	•	•	•	•	V, B, C, D
5R1	5.1 pF	•	•	•	•	•	V, B, C, D
5R6	5.6 pF	•	•	•	•	•	B, C, D
6R2	6.2 pF	•	•	•	•	•	B, C, D
6R8	6.8 pF	•	•	•	•	•	B, C, D
7R5	7.5 pF	•	•	•	•	•	B, C, D
8R2	8.2 pF	•	•	•	•	•	B, C, D
9R1	9.1 pF	•	•	•	•	•	B, C, D
100	10 pF	•	•	•	•	•	F, G, J, K, M
110	11 pF	•	•	•	•	•	F, G, J, K, M
120	12 pF	•	•	•	•	•	F, G, J, K, M
130	13 pF	•	•	•	•	•	F, G, J, K, M
150	15 pF	•	•	•	•	•	F, G, J, K, M
160	16 pF	•	•	•	•	•	F, G, J, K, M
180	18 pF	•	•	•	•	•	F, G, J, K, M

**Note**

- Plastic carrier tape



SELECTION CHART							
DIELECTRIC (VISHAY CODE)		COG (D)					
STYLE		GA0505					
CASE CODE		0505					
VOLTAGE (V <sub>DC</sub> )		50	100	150	200	250	TOLERANCE
VOLTAGE CODE		A	B	K	C	P	
CAP. CODE	CAP.						
200	20 pF	•	•	•	•	•	F, G, J, K, M
220	22 pF	•	•	•	•	•	F, G, J, K, M
240	24 pF	•	•	•	•	•	F, G, J, K, M
270	27 pF	•	•	•	•	•	F, G, J, K, M
300	30 pF	•	•	•	•	•	F, G, J, K, M
330	33 pF	•	•	•	•	•	F, G, J, K, M
360	36 pF	•	•	•	•	•	F, G, J, K, M
390	39 pF	•	•	•	•	•	F, G, J, K, M
430	43 pF	•	•	•	•	•	F, G, J, K, M
470	47 pF	•	•	•	•	•	F, G, J, K, M
510	51 pF	•	•	•	•	•	F, G, J, K, M
560	56 pF	•	•	•	•	•	F, G, J, K, M
620	62 pF	•	•	•	•	•	F, G, J, K, M
680	68 pF	•	•	•	•	•	F, G, J, K, M
750	75 pF	•	•	•	•	•	F, G, J, K, M
820	82 pF	•	•	•	•	•	F, G, J, K, M
910	91 pF	•	•	•	•	•	F, G, J, K, M
101	100 pF	•	•	•	•	•	F, G, J, K, M
111	110 pF	•	•	•	•	•	F, G, J, K, M
121	120 pF	•	•	•	•	•	F, G, J, K, M
131	130 pF	•	•	•	•	•	F, G, J, K, M
151	150 pF	•	•	•	•	•	F, G, J, K, M
161	160 pF	•	•	•	•	•	F, G, J, K, M
181	180 pF	•	•	•	•	•	F, G, J, K, M
201	200 pF	•	•	•	•	•	F, G, J, K, M
221	220 pF	•	•	•	•	•	F, G, J, K, M
241	240 pF	•	•	•	•	•	F, G, J, K, M
271	270 pF	•	•	•	•	•	F, G, J, K, M
301	300 pF	•	•	•	•	•	F, G, J, K, M
331	330 pF	•	•	•	•	•	F, G, J, K, M
361	360 pF	•	•	•	•	•	F, G, J, K, M
391	390 pF	•	•	•	•	•	F, G, J, K, M
431	430 pF	•	•	•	•	•	F, G, J, K, M
471	470 pF	•	•	•	•	•	F, G, J, K, M
511	510 pF	•	•	•	•	•	F, G, J, K, M
561	560 pF	•	•	•	•	•	F, G, J, K, M
621	620 pF	•	•	•	•	•	F, G, J, K, M
681	680 pF	•	•	•	•	•	F, G, J, K, M
751	750 pF	•	•	•	•	•	F, G, J, K, M
821	820 pF	•	•	•	•	•	F, G, J, K, M
911	910 pF	•	•	•	•	•	F, G, J, K, M
102	1000 pF	•	•	•	•	•	F, G, J, K, M
112	1100 pF						
122	1200 pF						

**Note**

- Plastic carrier tape



SELECTION CHART										
DIELECTRIC (VISHAY CODE)		C0G (D)								
STYLE		GA1111								
CASE CODE		1111								
VOLTAGE (V <sub>DC</sub> )		50	100	200	300	500	630	1000	1500	TOLERANCE
VOLTAGE CODE		A	B	C	D	E	L	G	R	
CAP. CODE	CAP.									
0R2	0.2 pF	•	•	•	•	•	•	•	•	V, B, C, D
0R3	0.3 pF	•	•	•	•	•	•	•	•	V, B, C, D
0R4	0.4 pF	•	•	•	•	•	•	•	•	V, B, C, D
0R5	0.5 pF	•	•	•	•	•	•	•	•	V, B, C, D
0R6	0.6 pF	•	•	•	•	•	•	•	•	V, B, C, D
0R7	0.7 pF	•	•	•	•	•	•	•	•	V, B, C, D
0R8	0.8 pF	•	•	•	•	•	•	•	•	V, B, C, D
0R9	0.9 pF	•	•	•	•	•	•	•	•	V, B, C, D
1R0	1.0 pF	•	•	•	•	•	•	•	•	V, B, C, D
1R1	1.1 pF	•	•	•	•	•	•	•	•	V, B, C, D
1R2	1.2 pF	•	•	•	•	•	•	•	•	V, B, C, D
1R3	1.3 pF	•	•	•	•	•	•	•	•	V, B, C, D
1R4	1.4 pF	•	•	•	•	•	•	•	•	V, B, C, D
1R5	1.5 pF	•	•	•	•	•	•	•	•	V, B, C, D
1R6	1.6 pF	•	•	•	•	•	•	•	•	V, B, C, D
1R7	1.7 pF	•	•	•	•	•	•	•	•	V, B, C, D
1R8	1.8 pF	•	•	•	•	•	•	•	•	V, B, C, D
1R9	1.9 pF	•	•	•	•	•	•	•	•	V, B, C, D
2R0	2.0 pF	•	•	•	•	•	•	•	•	V, B, C, D
2R1	2.1 pF	•	•	•	•	•	•	•	•	V, B, C, D
2R2	2.2 pF	•	•	•	•	•	•	•	•	V, B, C, D
2R4	2.4 pF	•	•	•	•	•	•	•	•	V, B, C, D
2R7	2.7 pF	•	•	•	•	•	•	•	•	V, B, C, D
3R0	3.0 pF	•	•	•	•	•	•	•	•	V, B, C, D
3R3	3.3 pF	•	•	•	•	•	•	•	•	V, B, C, D
3R6	3.6 pF	•	•	•	•	•	•	•	•	V, B, C, D
3R9	3.9 pF	•	•	•	•	•	•	•	•	V, B, C, D
4R3	4.3 pF	•	•	•	•	•	•	•	•	V, B, C, D
4R7	4.7 pF	•	•	•	•	•	•	•	•	V, B, C, D
5R1	5.1 pF	•	•	•	•	•	•	•	•	V, B, C, D
5R6	5.6 pF	•	•	•	•	•	•	•	•	B, C, D
6R2	6.2 pF	•	•	•	•	•	•	•	•	B, C, D
6R8	6.8 pF	•	•	•	•	•	•	•	•	B, C, D
7R5	7.5 pF	•	•	•	•	•	•	•	•	B, C, D
8R2	8.2 pF	•	•	•	•	•	•	•	•	B, C, D
9R1	9.1 pF	•	•	•	•	•	•	•	•	B, C, D
100	10 pF	•	•	•	•	•	•	•	•	F, G, J, K, M
110	11 pF	•	•	•	•	•	•	•	•	F, G, J, K, M
120	12 pF	•	•	•	•	•	•	•	•	F, G, J, K, M
130	13 pF	•	•	•	•	•	•	•	•	F, G, J, K, M
150	15 pF	•	•	•	•	•	•	•	•	F, G, J, K, M
160	16 pF	•	•	•	•	•	•	•	•	F, G, J, K, M
180	18 pF	•	•	•	•	•	•	•	•	F, G, J, K, M
200	20 pF	•	•	•	•	•	•	•	•	F, G, J, K, M
220	22 pF	•	•	•	•	•	•	•	•	F, G, J, K, M
240	24 pF	•	•	•	•	•	•	•	•	F, G, J, K, M
270	27 pF	•	•	•	•	•	•	•	•	F, G, J, K, M
300	30 pF	•	•	•	•	•	•	•	•	F, G, J, K, M
330	33 pF	•	•	•	•	•	•	•	•	F, G, J, K, M
360	36 pF	•	•	•	•	•	•	•	•	F, G, J, K, M
390	39 pF	•	•	•	•	•	•	•	•	F, G, J, K, M

**Note**

- Plastic carrier tape



SELECTION CHART										
DIELECTRIC (VISHAY CODE)		C0G (D)								
STYLE		GA1111								
CASE CODE		1111								
VOLTAGE (V <sub>DC</sub> )		50	100	200	300	500	630	1000	1500	TOLERANCE
VOLTAGE CODE		A	B	C	D	E	L	G	R	
CAP. CODE	CAP.									
430	43 pF	•	•	•	•	•	•	•	•	F, G, J, K, M
470	47 pF	•	•	•	•	•	•	•	•	F, G, J, K, M
510	51 pF	•	•	•	•	•	•	•	•	F, G, J, K, M
560	56 pF	•	•	•	•	•	•	•	•	F, G, J, K, M
620	62 pF	•	•	•	•	•	•	•	•	F, G, J, K, M
680	68 pF	•	•	•	•	•	•	•	•	F, G, J, K, M
750	75 pF	•	•	•	•	•	•	•	•	F, G, J, K, M
820	82 pF	•	•	•	•	•	•	•	•	F, G, J, K, M
910	91 pF	•	•	•	•	•	•	•	•	F, G, J, K, M
101	100 pF	•	•	•	•	•	•	•	•	F, G, J, K, M
111	110 pF	•	•	•	•	•	•	•	•	F, G, J, K, M
121	120 pF	•	•	•	•	•	•	•	•	F, G, J, K, M
131	130 pF	•	•	•	•	•	•	•	•	F, G, J, K, M
151	150 pF	•	•	•	•	•	•	•	•	F, G, J, K, M
161	160 pF	•	•	•	•	•	•	•	•	F, G, J, K, M
181	180 pF	•	•	•	•	•	•	•	•	F, G, J, K, M
201	200 pF	•	•	•	•	•	•	•	•	F, G, J, K, M
221	220 pF	•	•	•	•	•	•	•	•	F, G, J, K, M
241	240 pF	•	•	•	•	•	•	•	•	F, G, J, K, M
271	270 pF	•	•	•	•	•	•	•	•	F, G, J, K, M
301	300 pF	•	•	•	•	•	•	•	•	F, G, J, K, M
331	330 pF	•	•	•	•	•	•	•	•	F, G, J, K, M
361	360 pF	•	•	•	•	•	•	•	•	F, G, J, K, M
391	390 pF	•	•	•	•	•	•	•	•	F, G, J, K, M
431	430 pF	•	•	•	•	•	•	•	•	F, G, J, K, M
471	470 pF	•	•	•	•	•	•	•	•	F, G, J, K, M
511	510 pF	•	•	•	•	•	•	•	•	F, G, J, K, M
561	560 pF	•	•	•	•	•	•	•	•	F, G, J, K, M
621	620 pF	•	•	•	•	•	•	•	•	F, G, J, K, M
681	680 pF	•	•	•	•	•	•	•	•	F, G, J, K, M
751	750 pF	•	•	•	•	•	•	•	•	F, G, J, K, M
821	820 pF	•	•	•	•	•	•	•	•	F, G, J, K, M
911	910 pF	•	•	•	•	•	•	•	•	F, G, J, K, M
102	1000 pF	•	•	•	•	•	•	•	•	F, G, J, K, M
112	1100 pF	•	•	•	•	•	•	•	•	F, G, J, K, M
122	1200 pF	•	•	•	•	•	•	•	•	F, G, J, K, M
132	1300 pF	•	•	•	•	•	•	•	•	F, G, J, K, M
152	1500 pF	•	•	•	•	•	•	•	•	F, G, J, K, M
162	1600 pF	•	•	•	•	•	•	•	•	F, G, J, K, M
182	1800 pF	•	•	•	•	•	•	•	•	F, G, J, K, M
202	2000 pF	•	•	•	•	•	•	•	•	F, G, J, K, M
222	2200 pF	•	•	•	•	•	•	•	•	F, G, J, K, M
242	2400 pF	•	•	•	•	•	•	•	•	F, G, J, K, M
272	2700 pF	•	•	•	•	•	•	•	•	F, G, J, K, M
302	3000 pF	•	•	•	•	•	•	•	•	F, G, J, K, M
332	3300 pF	•	•	•	•	•	•	•	•	F, G, J, K, M

**Note**

- Plastic carrier tape



SELECTION CHART							
DIELECTRIC (VISHAY CODE)		C0G (D)					
STYLE		GA1206					
CASE CODE		1206					
VOLTAGE (V <sub>DC</sub> )		50	100	200	500	630	TOLERANCE
VOLTAGE CODE		A	B	C	E	L	
CAP. CODE	CAP.						
1R0	1.0 pF	•	•	•	•	•	B, C, D
1R2	1.2 pF	•	•	•	•	•	B, C, D
1R5	1.5 pF	•	•	•	•	•	B, C, D
1R8	1.8 pF	•	•	•	•	•	B, C, D
2R2	2.2 pF	•	•	•	•	•	B, C, D
2R7	2.7 pF	•	•	•	•	•	B, C, D
3R3	3.3 pF	•	•	•	•	•	B, C, D
3R9	3.9 pF	•	•	•	•	•	B, C, D
4R7	4.7 pF	•	•	•	•	•	B, C, D
5R6	5.6 pF	•	•	•	•	•	B, C, D
6R8	6.8 pF	•	•	•	•	•	B, C, D
8R2	8.2 pF	•	•	•	•	•	B, C, D
100	10 pF	•	•	•	•	•	F, G, J, K
120	12 pF	•	•	•	•	•	F, G, J, K
150	15 pF	•	•	•	•	•	F, G, J, K
180	18 pF	•	•	•	•	•	F, G, J, K
220	22 pF	•	•	•	•	•	F, G, J, K
270	27 pF	•	•	•	•	•	F, G, J, K
330	33 pF	•	•	•	•	•	F, G, J, K
390	39 pF	•	•	•	•	•	F, G, J, K
470	47 pF	•	•	•	•	•	F, G, J, K
560	56 pF	•	•	•	•	•	F, G, J, K
680	68 pF	•	•	•	•	•	F, G, J, K
820	82 pF	•	•	•	•	•	F, G, J, K

**Note**

- Plastic carrier tape



## HIGH FREQ DIELECTRIC - TYPICAL PARAMETERS

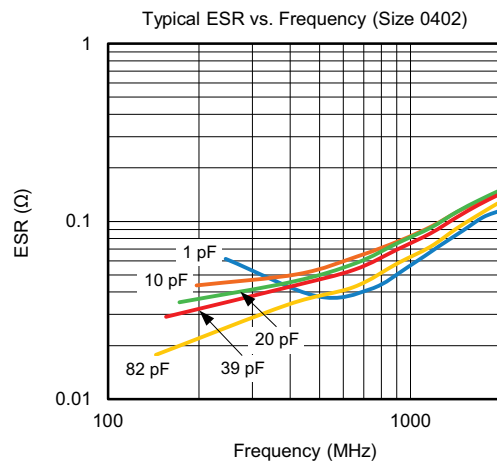
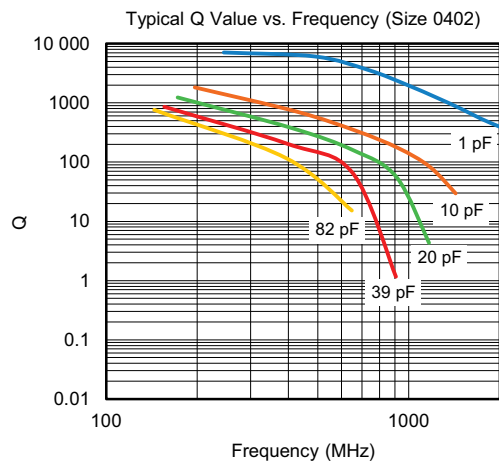
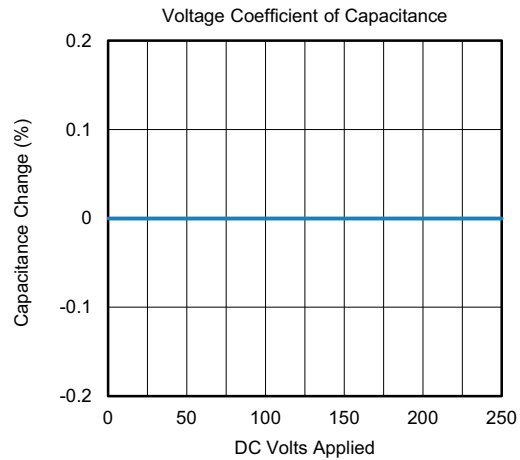
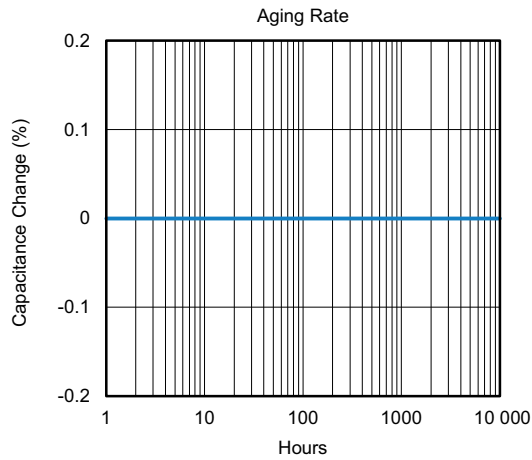
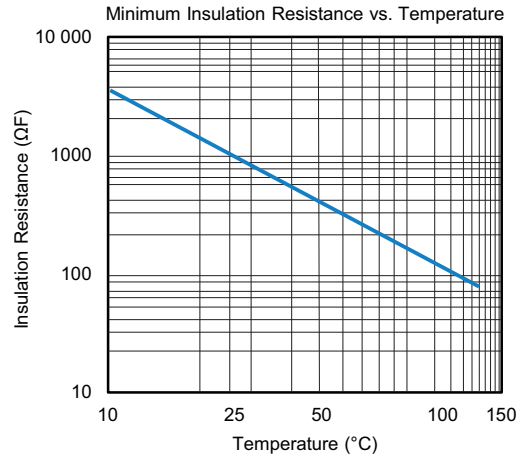
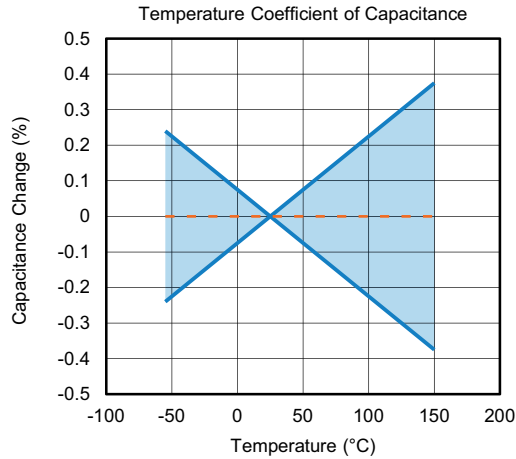



## HIGH FREQ DIELECTRIC - TYPICAL PARAMETERS

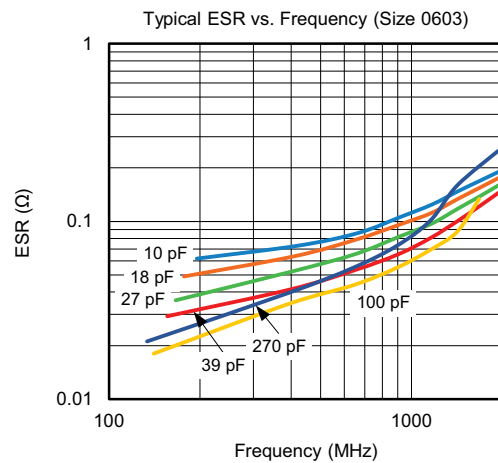
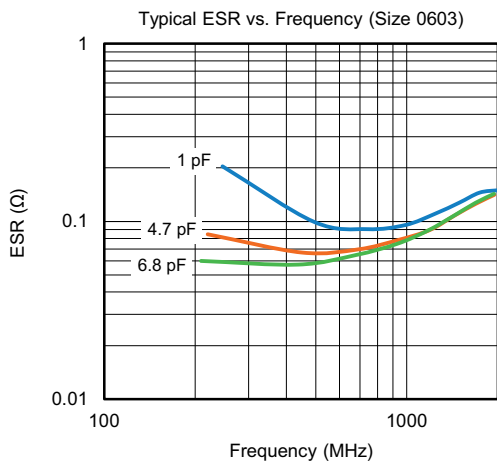
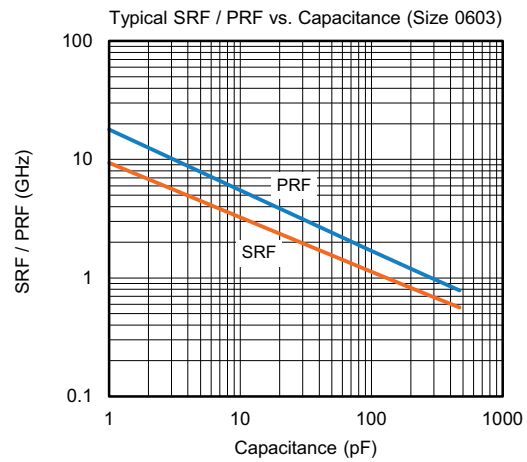
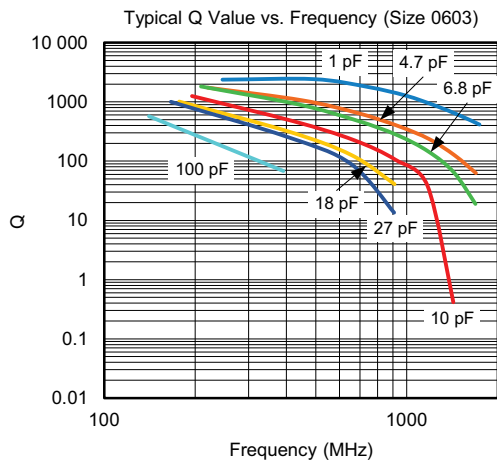
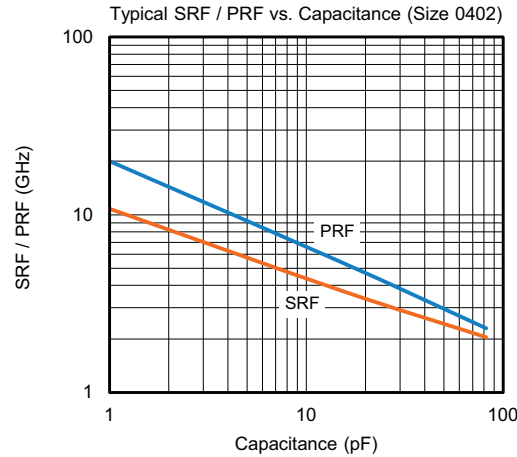



## HIGH FREQ DIELECTRIC - TYPICAL PARAMETERS

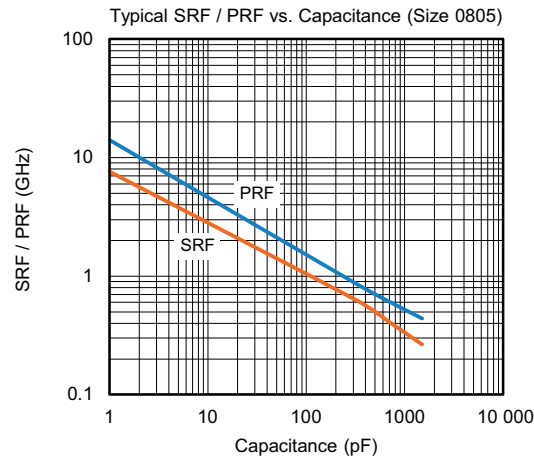
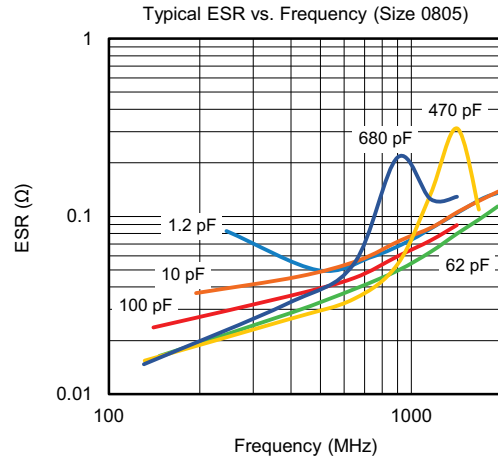
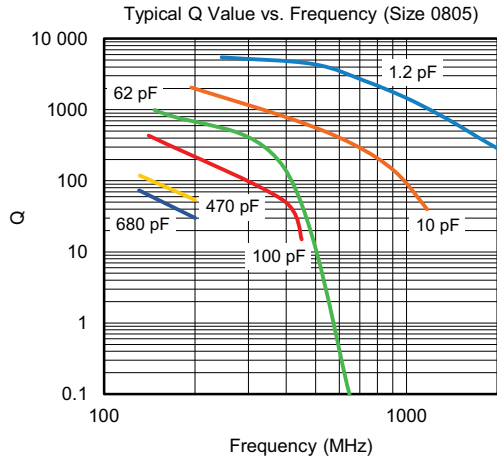

## QUAD HIGH FREQ DIELECTRIC - TYPICAL PARAMETERS

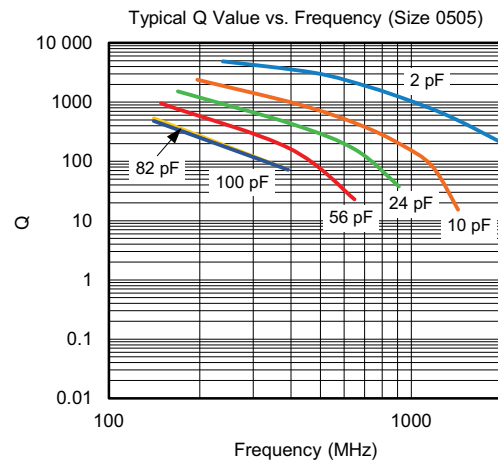
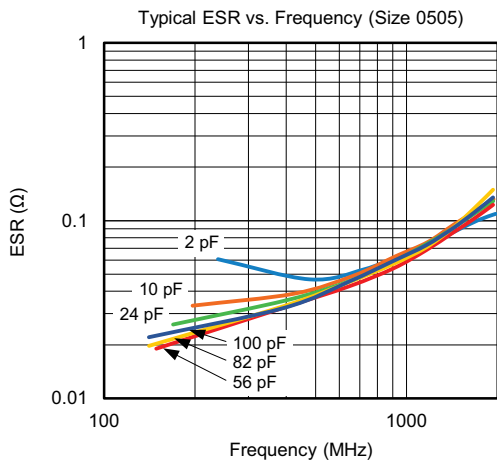





## QUAD HIGH FREQ DIELECTRIC - TYPICAL PARAMETERS

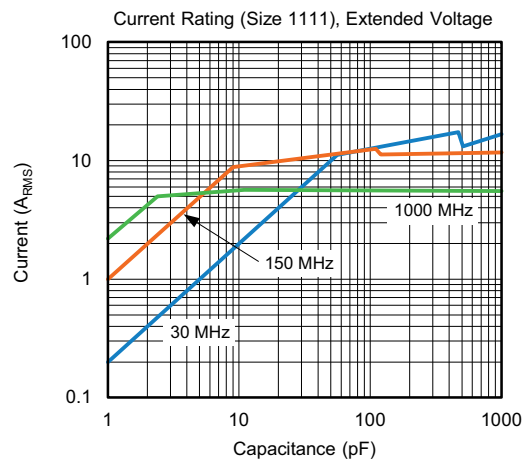
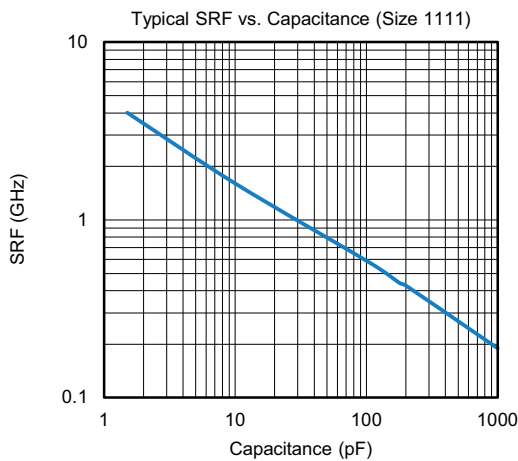
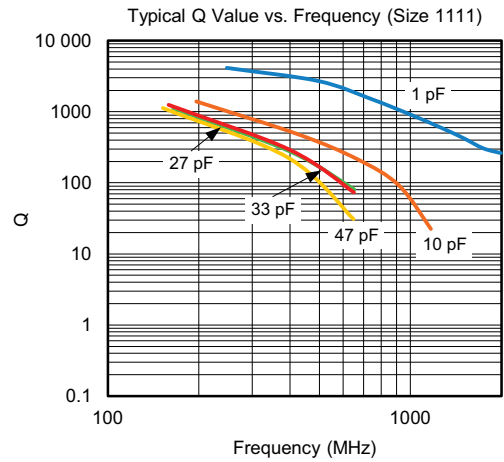
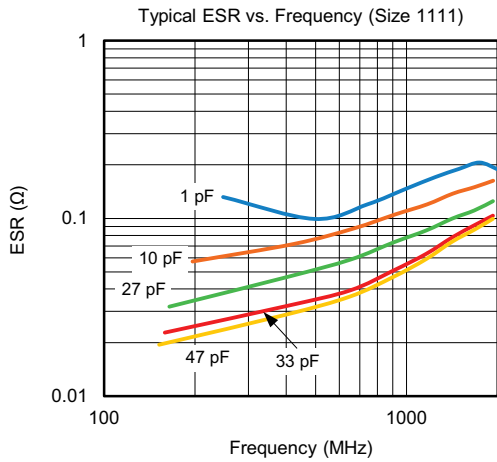
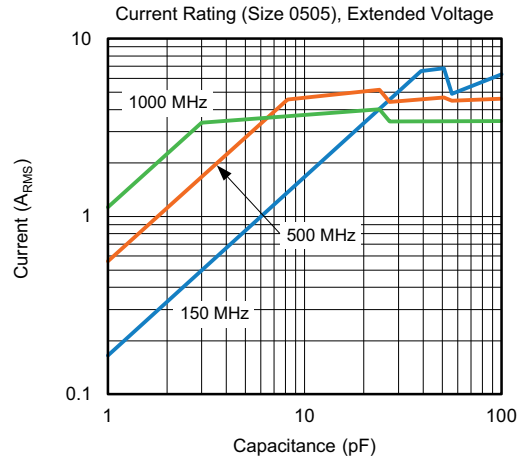
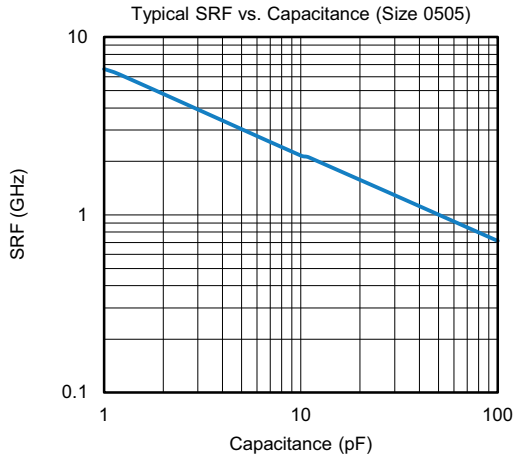



## 1 - GENERAL CERTIFICATES

# Quality management system according to ISO/IATF 16949: 2016	Yes
# Quality management system according to ISO 9001: 2015	Yes
# Environmental certification according to ISO 14001: 2015	Yes
# Health and safety system according to ISO 45001	Yes

## 2 - TECHNICAL REQUIREMENTS

Unless specified in component specification, these parameters are the minimum requirements for the components.

### 2.1 OPERATING TEMPERATURE RANGE

For standard applications	T <sub>A</sub> : -55 °C to +125 °C	See characteristics 2.3
For high temperature applications	T <sub>A</sub> : -55 °C to +150 °C	See characteristics 2.3
For ultra high temperature applications	T <sub>A</sub> : -55 °C to +175 °C	See characteristics 2.3

### 2.2 STORAGE AND HANDLING CONDITIONS

<p>(1) Store the components at 5 °C to 40 °C ambient temperature and ≤ 70 % relative humidity conditions.</p> <p>(2) The product is recommended to be used within a time-frame of 2 years after shipment. Check solderability in case extended shelf life beyond the expiry date is needed.</p> <p>Precautions:</p> <p>a. Do not store products in an environment containing corrosive elements, especially where chloride gas, sulfide gas, acid, alkali, salt or the like are present. This may cause corrosion or oxidization of the terminations, which can easily lead to poor soldering.</p> <p>b. Store products on the shelf and avoid exposure to moisture or dust.</p> <p>c. Do not expose products to excessive shock, vibration, direct sunlight and so on.</p>
---

### 2.3 CHARACTERISTICS

PARAMETER	CERAMIC TYPE	SYMBOL	RATINGS	TEST CONDITIONS / REMARKS
Rated voltage in temperature range -55 °C to +125 °C	C0G (D)	U <sub>R</sub>	25 V to 1500 V	
Derating at higher temperature up to +150 °C	C0G (D)	U <sub>R</sub>	25 V to 100 V	U <sub>DC</sub> ≤ 1/2 U <sub>R</sub>
Derating at higher temperature up to +175 °C	C0G (D)	U <sub>R</sub>	25 V to 100 V	U <sub>DC</sub> ≤ 1/4 U <sub>R</sub>
Temperature coefficient in temperature range -55 °C to +125 °C	C0G (D)	α <sub>C</sub>	≤ ± 30 ppm/°C	If C <sub>R</sub> < 10 pF: α <sub>C</sub> ≤ ± 120 ppm/°C
Temperature coefficient in temperature range -55 °C to +150 °C	C0G (D)	α <sub>C</sub>	≤ ± 30 ppm/°C	If C <sub>R</sub> < 10 pF: α <sub>C</sub> ≤ ± 120 ppm/°C
Dissipation factor in temperature range -55 °C to +175 °C	C0G (D)	tan δ	≤ 0.0005	



### 3 - LOT ACCEPTANCE TESTS

Process tests available in classes (on request)

GROUP	ACTION
A	Components are tested within the monitoring program of the supplier. The supplier shall submit the part numbers of the selected component to the customer during the component specification discussions.
B	Components (customer P/N) shall be tested quarterly. Records available only on special request by the customer.
C	Test with each shipment. Records are provided on a monthly basis. Customer special requirement; requirement should be determined in a specific component specification.

Upon request the records can be submitted in electronic format on monthly basis.

#### 3.1 THERMAL STRENGTH, THERMAL SHOCK SENSIBILITY

Sample size	200
Handling	Mounted on PCB
Thermal shock	1 x 280 °C, no pre-heat, 5 s to 10 s
IR - test (IRATS)	U = U <sub>R</sub> , T = room temperature, verified
Burn in (BIATS)	Equivalent to 12 h burn-in, 2 x U <sub>R</sub> /125 °C, verification time to failure

Acceptance criteria: zero defects (IRATS and BIATS).

#### 3.2 BOARD FLEX TEST

Sample size	20 pcs/lot
Frequency	At least three different part numbers of one component family matrix per quarter
Max. deflection	8 mm (data to be reported, available on request)

#### 3.3 SOLDERABILITY/RESISTANCE TO SOLDERING HEAT

Temperature profile for reflow soldering of SMD parts IPC/JEDEC-J-STD-020C.

Test is done on a regular basis for samples taken randomly out of the line.

Acceptance criteria: at least 95 % new solder and no detachment or leaching of terminations.

### 4 - ENVIRONMENTAL REQUIREMENTS

A list of the chemical substances content, which must not be used or whose use shall be limited by international law, is available on request.

Vishay confirms that the components specified in this specification do not contain asbestos nor cadmium, not even in the smallest volumes.

The manufacturer/supplier confirms that the component during normal handling, storage and assembly, as well as during operation in the automobile, is non toxic.

## 5 - INSPECTION CRITERIA

The supplier shall carry out visual examination with suitable equipment with approximately 10 x magnification and lighting appropriate to the specimen under test and the required quality level.

### Chipping

The components shall be free of cracks or fissures. Small damages which do not deteriorate the performance of the component shall be less than as defined in EIA 595.

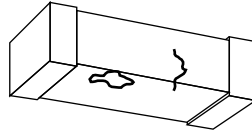

### Delamination or Exposed Electrodes

No visible separation or delamination between layers of the capacitor and no exposed electrodes between the two terminals of the capacitor must be seen.

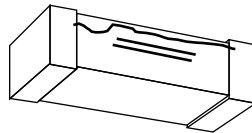

### Metallization

For the metallization, no visible detachment of the metallized terminals and no exposed electrodes must be seen. Defects and gaps in the metallization on each sides of the terminal must not exceed 10 % of the total area (e.g. A, B, C, ...).

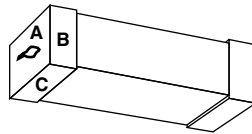

### Electrode Distance

The ceramic body shall be free of any conducting material between the terminals which reduces the distance of the electrodes. The minimum distance "D" is 400 µm for all package sizes, except 0402. For the component package 0402 the minimum distance is 200 µm.

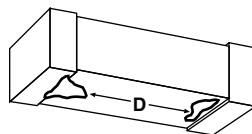

**6 - BOARD FLEX TEST CONDITIONS**
**6.1 BOARD FLEX DEFINITIONS OF TEST**

 PCB thickness =  $(1.6 \pm 0.1)$  mm

 Copper thickness = 35  $\mu$ m

Material FR4 (EP-GC 02 according to DIN 40 802)

<b>LAYOUT / PAD DESIGN</b> (Dimensions in mm)			
CASE CODE	PAD SIZE		
	LL	LB	LEL
0603	2.20	1.00	0.75
0805	3.40	1.30	1.20
1206	4.50	1.80	1.20

**Note**

- LL = total length; LB = width of the pad; LEL = single pad length

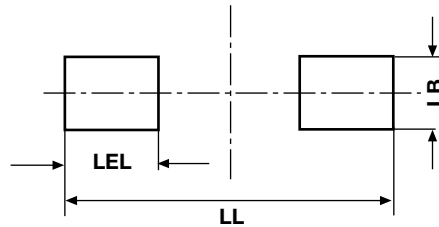

**6.2 SOLDERING INSTRUCTIONS**

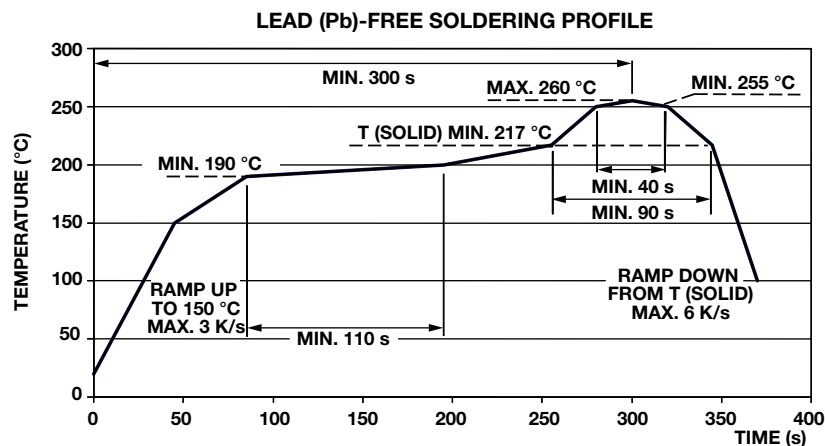
<b>THICKNESS, RECOMMENDED FOR SOLDER PASTE</b> (Reflow soldering)	
CASE CODE	THICKNESS IN $\mu$ m
0603	150 to 200
0805	150 to 200
1206	150 to 200

**6.3 TYPICAL TEMPERATURE PROFILE FOR REFLOW SOLDERING** (Boardflex test)

## 6.4 MOUNTING, DIMENSIONS AND TESTING

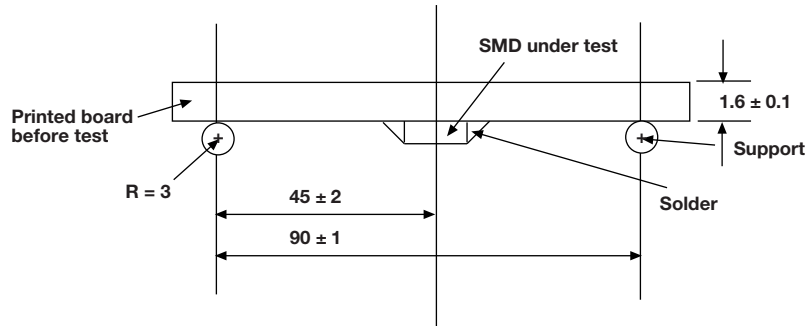
### Mounting



### Testing

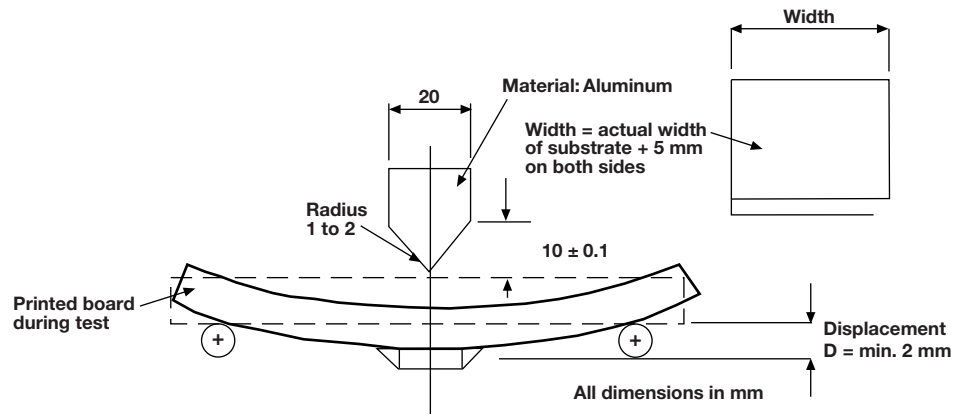

## 6.5 PERFORMANCE OF THE TEST(S)

- Electrical test according to component specification (Cap, DF, IR)
- Mounting to PCB
- Storage at room temperature (min. 10 h)
- Board flex test

## 6.6 DETAILS

C0G (D)	PCB to be deflected in steps until cracks or other damages are visible or can be measured. Dwell time between steps: $(5 \pm 1)$ s
---------	--

## 6.7 FAILURE CRITERIA

C0G (D)	$\Delta C/C < 1\%$ or $< 1$ pF, no failures up to min. 2 mm; Electrical test according to component specification
---------	--



## 7 - AEC-Q200 QUALIFICATION TESTING

NO.	AEC-Q200 TEST ITEM	REFERENCE
1	Pre- and post stress electrical test	User spec
3	High temp exposure (storage)	MIL-STD-202, method 108
4	Temperature cycling	JESD22, method JA-104
5	Destructive physical analysis	EIA-469
6	Moisture resistance	MIL-STD-202, method 106
7	Biased humidity	MIL-STD-202, method 103
8	Operation life	MIL-STD-202 method 108
9	External Visual	MIL-STD-883 method 2009
10	Physical dimension	JESD22, method JB-100
13	Mechanical shock	MIL-STD-202, method 213
14	Vibration	MIL-STD-202, method 204
15	Resistance to solder heat	MIL-STD-202, method 210
17	ESD	AEC-Q200-002
18	Solderability	J-STD-002
19	Electrical characterization	User spec
21	Board flex	AEC-Q200-005
22	Terminal strength	AEC-Q200-006
23	Beam load	AEC-Q200-003

STANDARD PACKAGING QUANTITIES (1)(2)(3)(6)						
CASE CODE	TAPE SIZE	7" REEL QUANTITIES			11 1/4" AND 13" REEL QUANTITIES	
		PAPER TAPE PACKAGING CODE "C" / "O"	PLASTIC TAPE PACKAGING CODE "T"	LOW QUANTITY "J" (5)	PAPER TAPE PACKAGING CODE "P" / "I"	PLASTIC TAPE PACKAGING CODE "R"
0402	8 mm	5000	n/a	1000	10 000	n/a
0603 (4)	8 mm	4000	4000	1000	10 000	10 000
0805	8 mm	n/a	3000	1000	n/a	10 000
0505	8 mm	n/a	3000	1000	n/a	10 000
1111	8 mm	n/a	2500	1000	n/a	9000
1206	8 mm	n/a	3000	1000	n/a	10 000

### Notes

- (1) Vishay Vitramon uses embossed plastic carrier tape
- (2) REFERENCE: EIA standard RS 481 - "Taping of Surface Mount Components for Automatic Placement"
- (3) n/a = not available
- (4) Packaging "C" / "P" / "O" / "I" and "T" / "R" or lower quantities can depend from product thickness
- (5) Paper / plastic tape used by availability
- (6) Final quantities for packaging can depend on product thickness

## Solder Pad Dimensions for Vishay Surface-Mount Multilayer Ceramic Chip Capacitors

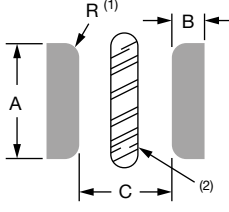
DIMENSIONS in millimeters			
			
CASE CODE	A	B	C
0402	0.50	0.50	0.40
0505	1.35	1.00	0.60
0603	0.90	1.00	1.00 <sup>(3)</sup>
0805	1.30	1.20	1.00
1111	2.90	1.30	1.75
1206	1.80	1.20	2.10
1210	2.80	1.30	1.90
1808	2.40	1.50	3.00
1812	3.60	1.50	3.00
1825	6.50	1.50	3.00
2008	2.70	1.50	4.08
2220	5.50 <sup>(4)</sup>	1.50	4.20
2225	6.50	1.50	4.20
2525	6.60	1.50	4.50
3040	10.80	2.00	5.50
3640	10.80	2.00	7.00
3838	10.20	2.00	7.50
4044	12.30	2.00	8.00

### Notes

- (1) For safety capacitors and voltages above 3000 V, corner rounding (R) of 0.5 mm is recommended to suppress arcing
- (2) Add a 1 mm slot in PCB between pads to allow cleaning and coating under MLCC
- (3) For VJ HiFREQ Series, this dimension is 0.6 mm
- (4) For safety capacitors, the A dimension should be 5.80 mm





## PRINTED CIRCUIT BOARD PCB DESIGN CONSIDERATIONS FOR HIGH VOLTAGE SURFACE-MOUNT MLCCS

Special assembly process and design considerations should be employed for today's high voltage rating MLCCs. As case sizes remain the same and voltage ratings increase, MLCC manufacturers must design, evaluate, and qualify their capacitors using methods that reduce the occurrence of corona discharge and arcover events. To meet similar capability in high voltage applications, users should employ similar cautionary design and assembly methods.

### MLCC PAD LAYOUT

A capacitor's arcover inception point can degrade due to factors such as the MLCC termination, PCB pad design, PCB cleanliness, solder flux residue, surface contamination / deposits and environmental conditions. PCB pads and their design affect the air gap distance between the opposing polarities of the MLCC termination. For voltage rating greater than 1500 V<sub>DC</sub> add a corner radius to the inward facing edge of the MLCC pads and as large a gap as possible between the pads. Too small of a pad gap distance will reduce the capacitor's own arcover inception voltage level. Refer to the Figure and Table Figure 1.0, MLCC Pad Layout and Table 1.0, Vishay MLCC Solder Pad Dimensions for the recommended MLCC solder pad dimensions.

### SLOT OR TRENCH BETWEEN PADS

PCB assembly can deposit dust, trap solder balls, or flux residue underneath the capacitors. These contaminants will reduce conductive clearances and the arcover inception level. Assembly methods must include a final PCB cleaning process. A slot or trench can be cut into the PCB in between the pads to allow cleaners to penetrate underneath the MLCC. The slot will also allow conformal or epoxy coatings to flow underneath the MLCC and build an insulative barrier between pads. Refer to Figure 1.0 MLCC Pad Layout for slot reference location.

### COATING PRINTED CIRCUIT BOARD

Coating a printed circuit board with materials such as acrylic, silicone and urethane resins provide a protective dielectric barrier that is non-conductive and will enhance the resistance to arcing. Various processes exist which include dipping, brushing, and spaying. Optimal performance will come from coating the MLCC on all sides, top and bottom. The PCB slot in between the pads should extend slightly beyond the width of the MLCC. Refer to Figure 1.0 MLCC Pad Layout for slot reference location.



## **Disclaimer**

ALL PRODUCT, PRODUCT SPECIFICATIONS AND DATA ARE SUBJECT TO CHANGE WITHOUT NOTICE TO IMPROVE RELIABILITY, FUNCTION OR DESIGN OR OTHERWISE.

Vishay Intertechnology, Inc., its affiliates, agents, and employees, and all persons acting on its or their behalf (collectively, "Vishay"), disclaim any and all liability for any errors, inaccuracies or incompleteness contained in any datasheet or in any other disclosure relating to any product.

Vishay makes no warranty, representation or guarantee regarding the suitability of the products for any particular purpose or the continuing production of any product. To the maximum extent permitted by applicable law, Vishay disclaims (i) any and all liability arising out of the application or use of any product, (ii) any and all liability, including without limitation special, consequential or incidental damages, and (iii) any and all implied warranties, including warranties of fitness for particular purpose, non-infringement and merchantability.

Statements regarding the suitability of products for certain types of applications are based on Vishay's knowledge of typical requirements that are often placed on Vishay products in generic applications. Such statements are not binding statements about the suitability of products for a particular application. It is the customer's responsibility to validate that a particular product with the properties described in the product specification is suitable for use in a particular application. Parameters provided in datasheets and / or specifications may vary in different applications and performance may vary over time. All operating parameters, including typical parameters, must be validated for each customer application by the customer's technical experts. Product specifications do not expand or otherwise modify Vishay's terms and conditions of purchase, including but not limited to the warranty expressed therein.

Hyperlinks included in this datasheet may direct users to third-party websites. These links are provided as a convenience and for informational purposes only. Inclusion of these hyperlinks does not constitute an endorsement or an approval by Vishay of any of the products, services or opinions of the corporation, organization or individual associated with the third-party website. Vishay disclaims any and all liability and bears no responsibility for the accuracy, legality or content of the third-party website or for that of subsequent links.

Vishay products are not designed for use in life-saving or life-sustaining applications or any application in which the failure of the Vishay product could result in personal injury or death unless specifically qualified in writing by Vishay. Customers using or selling Vishay products not expressly indicated for use in such applications do so at their own risk. Please contact authorized Vishay personnel to obtain written terms and conditions regarding products designed for such applications.

No license, express or implied, by estoppel or otherwise, to any intellectual property rights is granted by this document or by any conduct of Vishay. Product names and markings noted herein may be trademarks of their respective owners.