



Vishay Dale Thin Film Land Patterns

1. Scope

This technical note provides sample land patterns for Vishay Dale Thin Film SMT resistive products. The following drawings are based on IPC-SM-782 surface-mount design and land pattern standard. These drawings are for reference only Vishay Thin Film recommends that the user contacts their PC board supplier for actual land patterns required. The pads are intended for lead (Pb)-free and tin / lead solder types.

2. Product Series

Thin Film Surface-Mount Chip Resistors (FC, L, P, PTN, PLT, PLTT, PLTU, PAT, PATT, PNM, THJP, M/D55342 QPL Series)

0402 Land Pattern

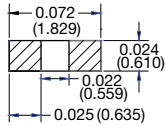

0502 Land Pattern

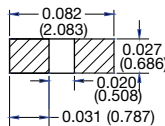

0505 Land Pattern

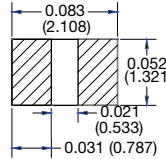

0603 Land Pattern

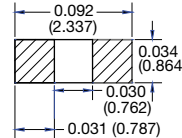

0705 Land Pattern

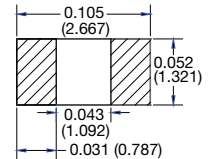

1005 Land Pattern

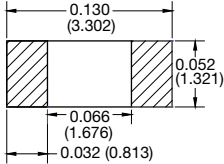

1010 Land Pattern

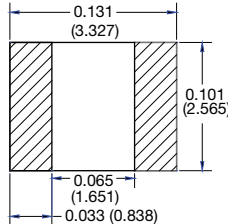

1206 Land Pattern

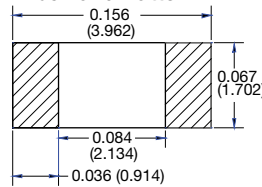

1505 Land Pattern

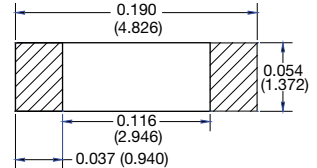

2010 Land Pattern

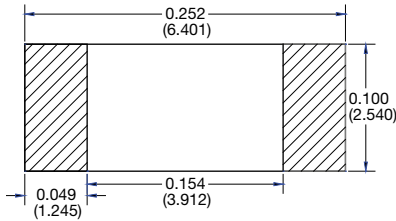

2208 Land Pattern

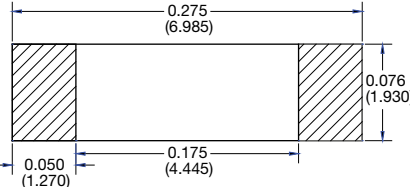

2512 Land Pattern

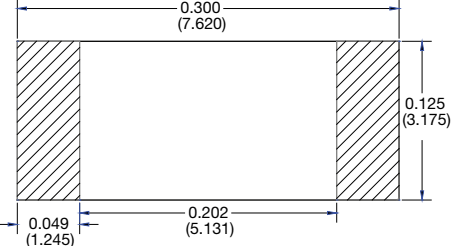



Thin Film Surface-Mount Chip Resistors (PHP, PCAN Series)

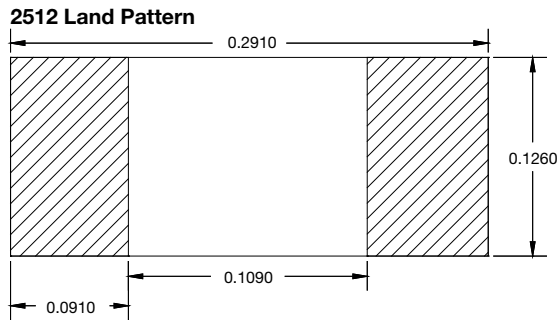
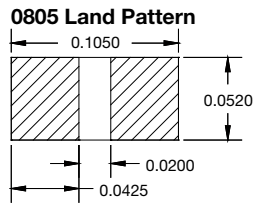
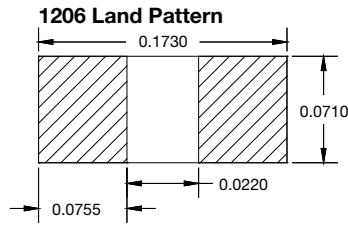
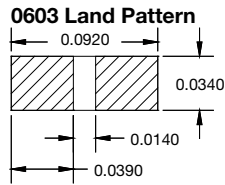

Thin Film Surface-Mount Chip Resistors Long Axis Termination (THJP, L Series)

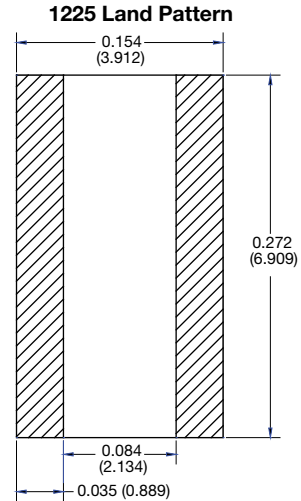
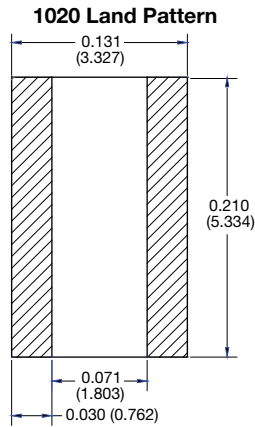
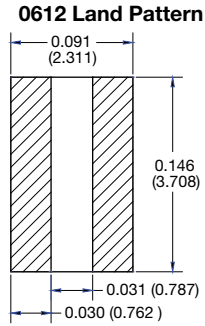
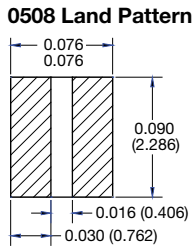



Surface-Mount Networks (MPM, MP3, MP4 Series)

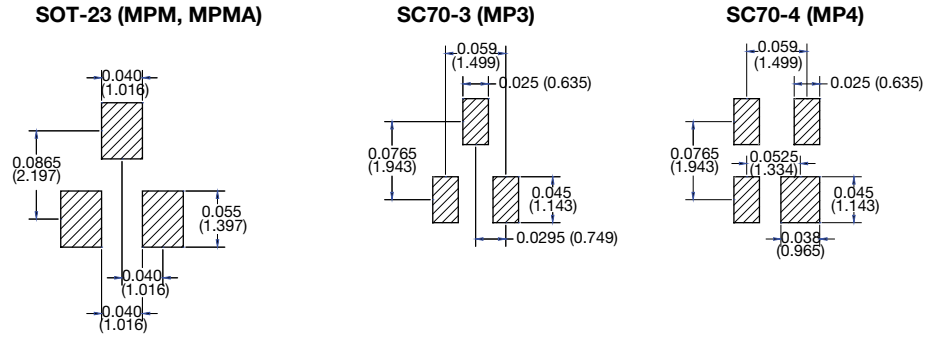

Surface-Mount Networks SOIC Narrow Body 150 mils (ORN, CSO, MOMC, HTRN, AORN, MORN Series)

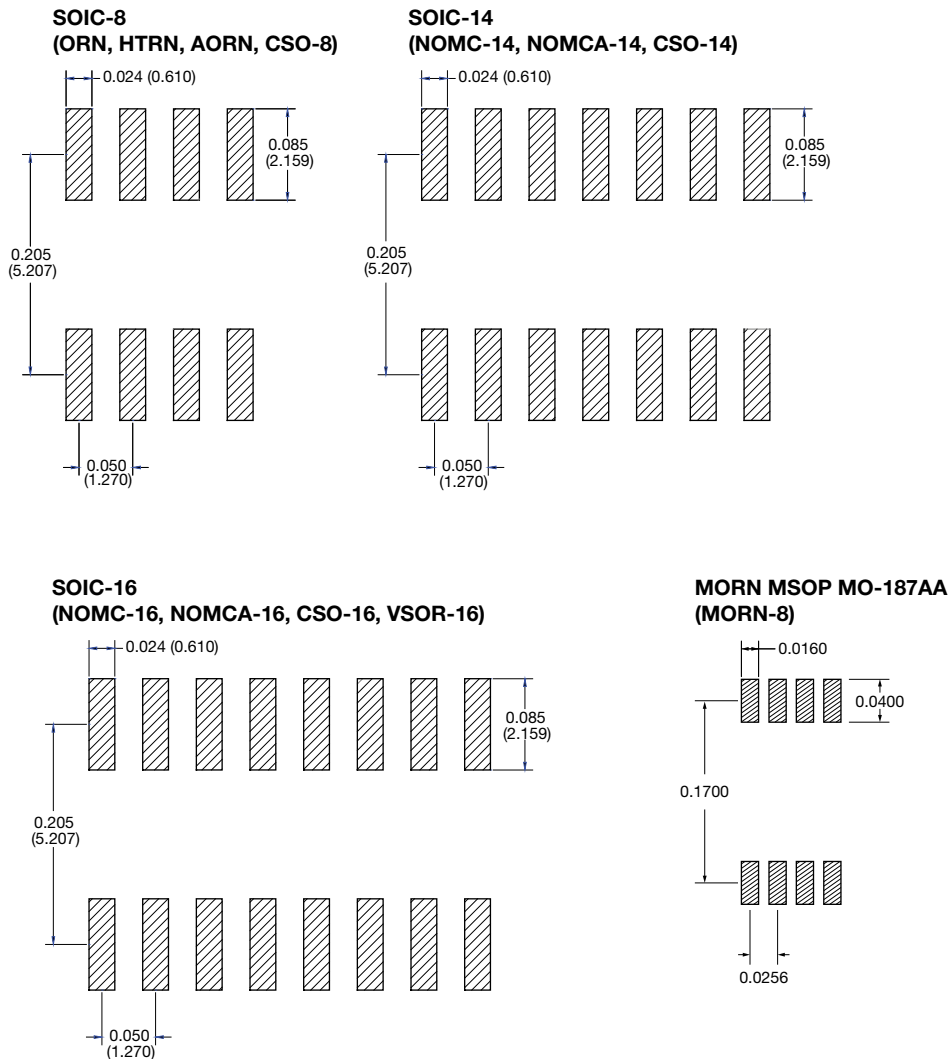



Surface-Mount Networks SOIC Medium Body 220 mils (TOMC Series)

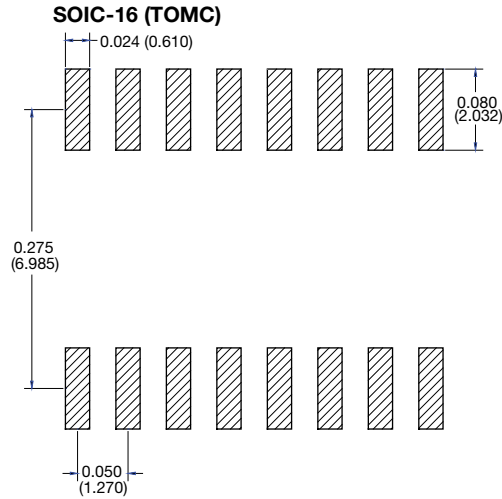

Surface-Mount Networks SOIC Wide Body 300 mils (WOMC Series)

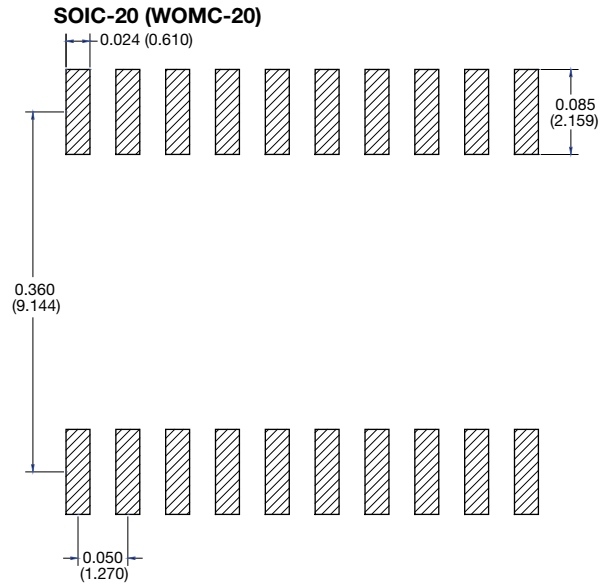
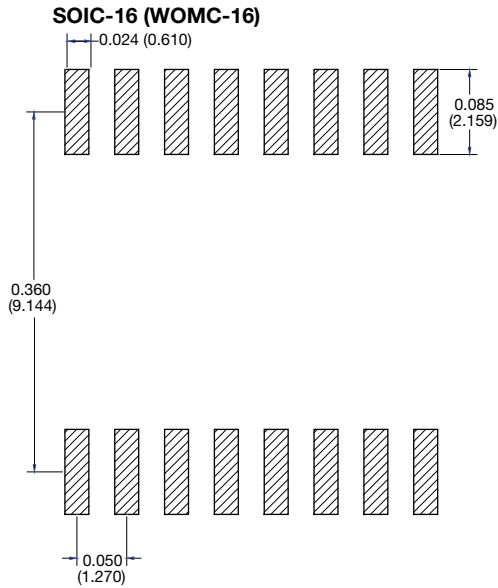



Surface-Mount Networks High Density SSOP, TSOP (VSSR, VTSR Series)

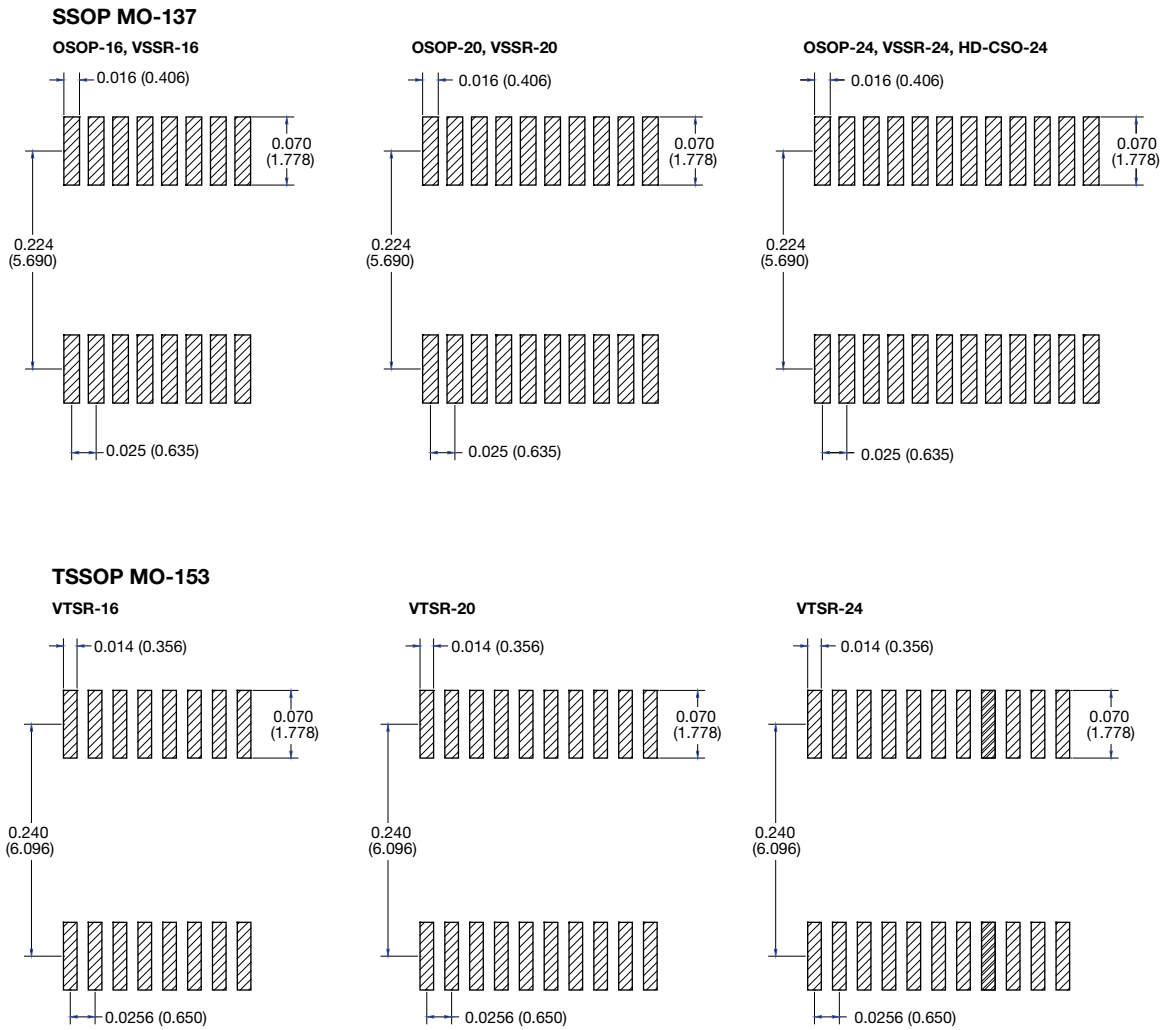

Surface-Mount Leadless Networks (LCC Series)

16 Pin LCC

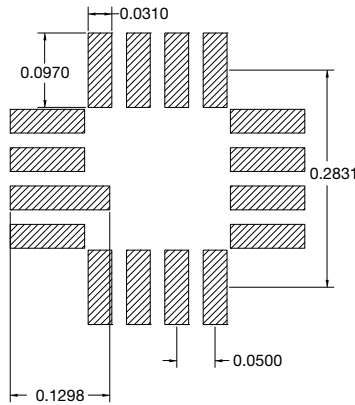

20 Pin LCC

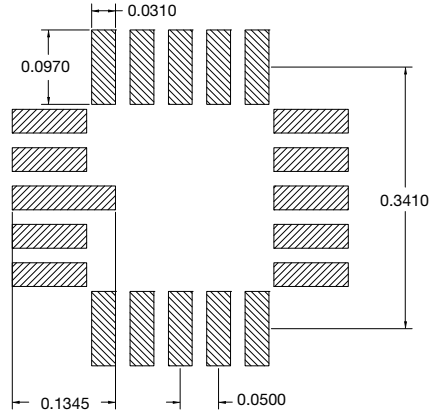

Surface-Mount Leadless Networks (MPH Series)

4 Pin LCC

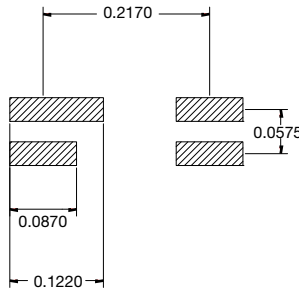

Surface-Mount Leadless Packages DUAL/ QUAD Flat No Lead (DFN, QFN Series)

DFN MLP

DFN-8 4 x 5 mm Sq

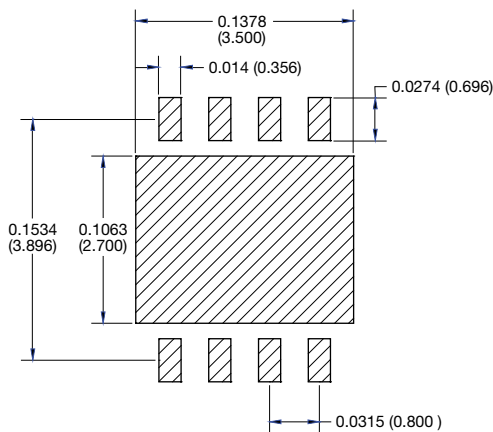

QFN MLP

QFN-20 5 x 5 mm Sq

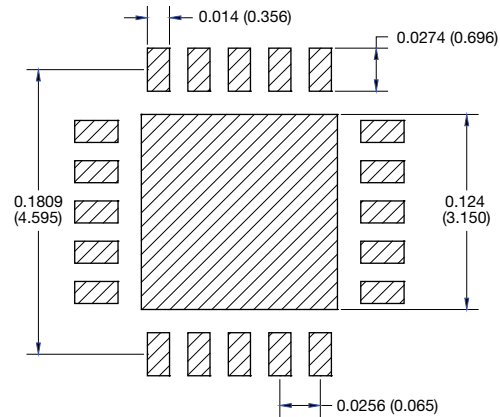



Surface-Mount Leadless Resistor Arrays (PR Series)

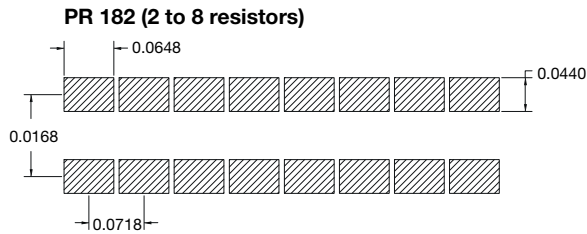
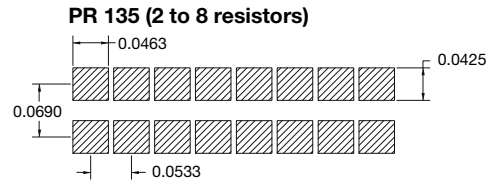
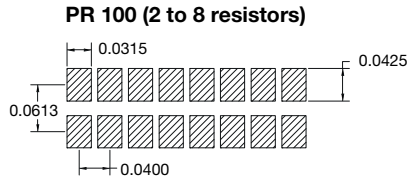

Note

- All dimensions in inches (mm)

Flatpack

14 Pin Bottom Brazed Flatpack

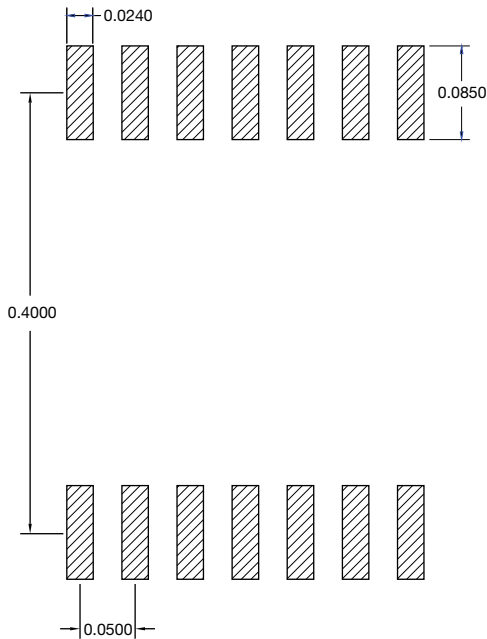

16 Pin Bottom Brazed Flatpack

