

## N-Channel 20 V (D-S) MOSFET

### DESCRIPTION

The attached SPICE model describes the typical electrical characteristics of the n-channel vertical DMOS. The sub-circuit model is extracted and optimized over the -55 °C to +125 °C temperature ranges under the pulsed 0 V to 5 V gate drive. The saturated output impedance is best fit at the gate bias near the threshold voltage.

A novel gate-to-drain feedback capacitance network is used to model the gate charge characteristics while avoiding convergence difficulties of the switched  $C_{gd}$  model. All model parameter values are optimized to provide a best fit to the measured electrical data and are not intended as an exact physical interpretation of the device.

### CHARACTERISTICS

- N-Channel Vertical DMOS
- Macro Model (Sub-circuit Model)
- Level 3 MOS
- Apply for both Linear and Switching Application
- Accurate over the -55 °C to +125 °C Temperature Range
- Model the Gate Charge

### SUBCIRCUIT MODEL SCHEMATIC

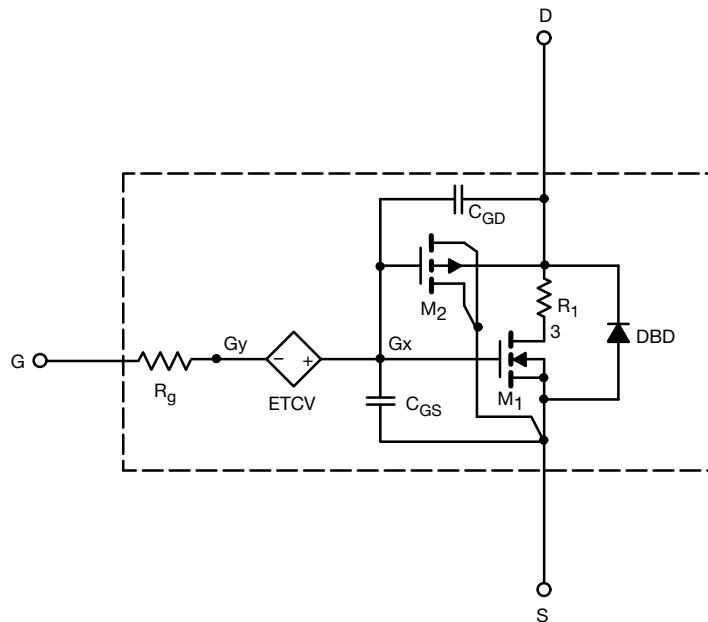

### Note

- This document is intended as a SPICE modeling guideline and does not constitute a commercial product datasheet. Designers should refer to the appropriate datasheet of the same number for guaranteed specification limits.



<b>SPECIFICATIONS</b> ( $T_J = 25\text{ }^\circ\text{C}$ , unless otherwise noted)					
PARAMETER	SYMBOL	TEST CONDITIONS	SIMULATED DATA	MEASURED DATA	UNIT
<b>Static</b>					
Gate Threshold Voltage	$V_{GS(th)}$	$V_{DS} = V_{GS}, I_D = 250\text{ }\mu\text{A}$	0.55	-	V
Drain-Source On-State Resistance <sup>a</sup>	$R_{DS(on)}$	$V_{GS} = 4.5\text{ V}, I_D = 1.5\text{ A}$	0.031	0.030	$\Omega$
		$V_{GS} = 2.5\text{ V}, I_D = 1\text{ A}$	0.035	0.033	
Forward Transconductance <sup>a</sup>	$g_{fs}$	$V_{DS} = 10\text{ V}, I_D = 1.5\text{ A}$	15	17	S
Diode Forward Voltage	$V_{SD}$	$I_S = 1.5\text{ A}$	0.63	0.70	V
<b>Dynamic <sup>b</sup></b>					
Input Capacitance	$C_{iss}$	$V_{DS} = 10\text{ V}, V_{GS} = 0\text{ V}, f = 1\text{ MHz}$	629	620	pF
Output Capacitance	$C_{oss}$		112	110	
Reverse Transfer Capacitance	$C_{rss}$		41	40	
Total Gate Charge	$Q_g$	$V_{DS} = 10\text{ V}, V_{GS} = 8\text{ V}, I_D = 1.5\text{ A}$	9	10.4	nC
Gate-Source Charge	$Q_{gs}$	$V_{DS} = 10\text{ V}, V_{GS} = 4.5\text{ V}, I_D = 1.5\text{ A}$	5.3	5.9	
Gate-Source Charge	$Q_{gs}$		0.7	0.7	
Gate-Drain Charge	$Q_{gd}$		0.66	0.66	

**Notes**

- a. Pulse test; pulse width  $\leq 300\text{ }\mu\text{s}$ , duty cycle  $\leq 2\%$ .
- b. Guaranteed by design, not subject to production testing.



## COMPARISON OF MODEL WITH MEASURED DATA ( $T_J = 25\text{ }^\circ\text{C}$ , unless otherwise noted)

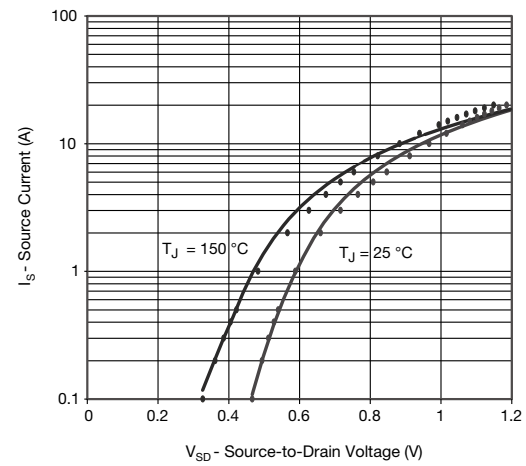
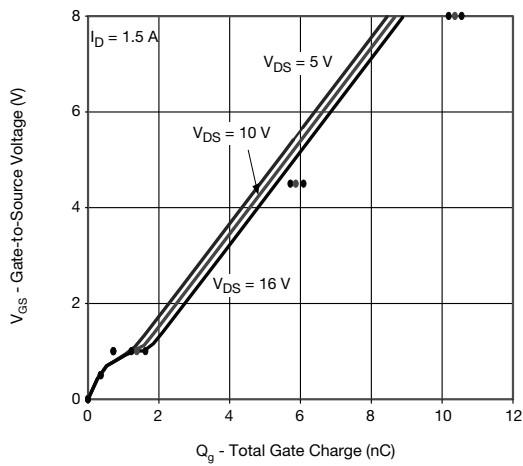
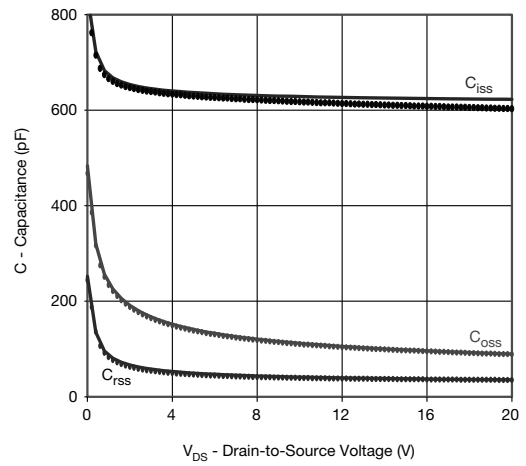
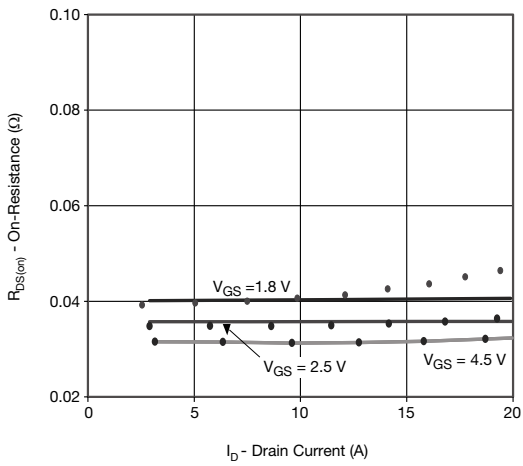
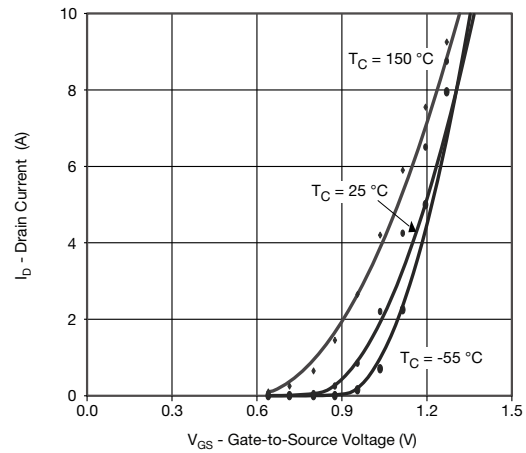
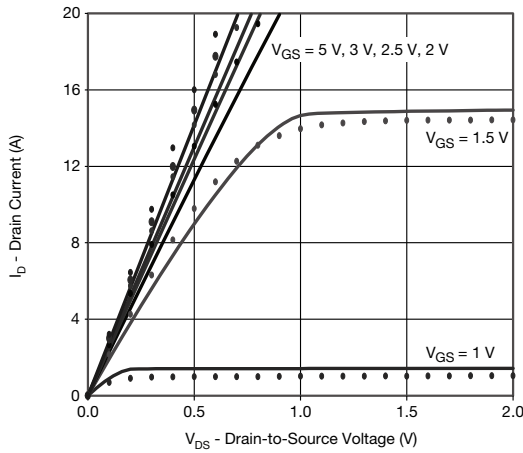

### Note

- Dots and squares represent measured data.

Copyright: Vishay Intertechnology, Inc.



## Disclaimer

ALL PRODUCT, PRODUCT SPECIFICATIONS AND DATA ARE SUBJECT TO CHANGE WITHOUT NOTICE TO IMPROVE RELIABILITY, FUNCTION OR DESIGN OR OTHERWISE.

Vishay Intertechnology, Inc., its affiliates, agents, and employees, and all persons acting on its or their behalf (collectively, "Vishay"), disclaim any and all liability for any errors, inaccuracies or incompleteness contained in any datasheet or in any other disclosure relating to any product.

Vishay makes no warranty, representation or guarantee regarding the suitability of the products for any particular purpose or the continuing production of any product. To the maximum extent permitted by applicable law, Vishay disclaims (i) any and all liability arising out of the application or use of any product, (ii) any and all liability, including without limitation special, consequential or incidental damages, and (iii) any and all implied warranties, including warranties of fitness for particular purpose, non-infringement and merchantability.

Statements regarding the suitability of products for certain types of applications are based on Vishay's knowledge of typical requirements that are often placed on Vishay products in generic applications. Such statements are not binding statements about the suitability of products for a particular application. It is the customer's responsibility to validate that a particular product with the properties described in the product specification is suitable for use in a particular application. Parameters provided in datasheets and/or specifications may vary in different applications and performance may vary over time. All operating parameters, including typical parameters, must be validated for each customer application by the customer's technical experts. Product specifications do not expand or otherwise modify Vishay's terms and conditions of purchase, including but not limited to the warranty expressed therein.

Except as expressly indicated in writing, Vishay products are not designed for use in medical, life-saving, or life-sustaining applications or for any other application in which the failure of the Vishay product could result in personal injury or death. Customers using or selling Vishay products not expressly indicated for use in such applications do so at their own risk. Please contact authorized Vishay personnel to obtain written terms and conditions regarding products designed for such applications.

No license, express or implied, by estoppel or otherwise, to any intellectual property rights is granted by this document or by any conduct of Vishay. Product names and markings noted herein may be trademarks of their respective owners.

## Material Category Policy

**Vishay Intertechnology, Inc. hereby certifies that all its products that are identified as RoHS-Compliant fulfill the definitions and restrictions defined under Directive 2011/65/EU of The European Parliament and of the Council of June 8, 2011 on the restriction of the use of certain hazardous substances in electrical and electronic equipment (EEE) - recast, unless otherwise specified as non-compliant.**

**Please note that some Vishay documentation may still make reference to RoHS Directive 2002/95/EC. We confirm that all the products identified as being compliant to Directive 2002/95/EC conform to Directive 2011/65/EU.**

**Vishay Intertechnology, Inc. hereby certifies that all its products that are identified as Halogen-Free follow Halogen-Free requirements as per JEDEC JS709A standards. Please note that some Vishay documentation may still make reference to the IEC 61249-2-21 definition. We confirm that all the products identified as being compliant to IEC 61249-2-21 conform to JEDEC JS709A standards.**