

Dual N-Channel 30-V (D-S) MOSFET with Schottky Diode

PRODUCT SUMMARY			
	V _{DS} (V)	R _{DS(on)} (Ω)	I _D (A)
Channel-1	30	0.022 at V _{GS} = 10 V	6.3
		0.030 at V _{GS} = 4.5 V	5.4
Channel-2		0.013 at V _{GS} = 10 V	10
		0.0185 at V _{GS} = 4.5 V	8.6

SCHOTTKY PRODUCT SUMMARY		
V _{DS} (V)	V _{SD} (V) Diode Forward Voltage	I _F (A)
30	0.50 V at 1.0 A	2.0

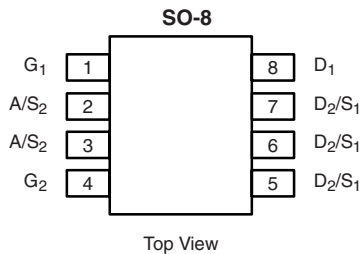

FEATURES

- Halogen-free According to IEC 61249-2-21 Definition
- LITTLE FOOT® Plus Power MOSFET
- 100 % R_g Tested
- Compliant to RoHS Directive 2002/95/EC



RoHS
COMPLIANT
HALOGEN
FREE
Available

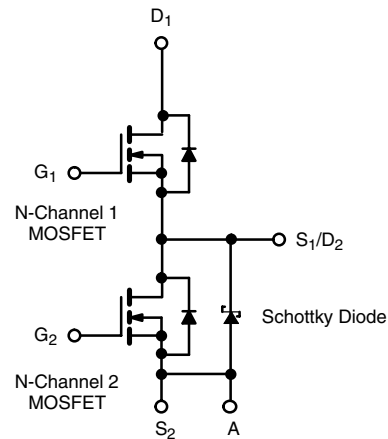

Ordering Information: Si4816DY-T1-E3 (Lead (Pb)-free)
Si4816DY-T1-GE3 (Lead (Pb)-free and Halogen-free)

ABSOLUTE MAXIMUM RATINGS T _A = 25 °C, unless otherwise noted							
Parameter	Symbol	Channel-1		Channel-2		Unit	
		10 s	Steady State	10 s	Steady State		
Drain-Source Voltage	V _{DS}	30				V	
Gate-Source Voltage	V _{GS}	20					
Continuous Drain Current (T _J = 150 °C) ^a	I _D	T _A = 25 °C	6.3	5.3	10	7.7	A
		T _A = 70 °C	5.4	4.2	8.2	6.2	
Pulsed Drain Current	I _{DM}	30		40			
Continuous Source Current (Diode Conduction) ^a	I _S	1.3	0.9	2.2	1.15		
Avalanche Current ^b	L = 0.1 mH	I _{AS}	12		25		
Single Pulse Avalanche Energy ^b		E _{AS}	7.2		31.25		mJ
Maximum Power Dissipation ^a	T _A = 25 °C	P _D	1.4	1.0	2.4	1.25	W
			T _A = 70 °C	0.9	0.64	1.5	
Operating Junction and Storage Temperature Range	T _J , T _{stg}	- 55 to 150				°C	

THERMAL RESISTANCE RATINGS									
Parameter	Symbol	Channel-1		Channel-2		Schottky		Unit	
		Typ.	Max.	Typ.	Max.	Typ.	Max.		
Maximum Junction-to-Ambient ^a	t ≤ 10 s	R _{thJA}	72	90	43	53	48	60	°C/W
	Steady State		100	125	82	100	80	100	
Maximum Junction-to-Foot (Drain)	Steady State	R _{thJC}	51	63	25	30	28	35	

Notes:

- Surface Mounted on 1" x 1" FR4 board.
- Starting date code W46BAA.

MOSFET SPECIFICATIONS $T_J = 25\text{ }^\circ\text{C}$, unless otherwise noted						
Parameter	Symbol	Test Conditions	Min.	Typ. ^a	Max.	Unit
Static						
Gate Threshold Voltage	$V_{GS(th)}$	$V_{DS} = V_{GS}, I_D = 250\text{ }\mu\text{A}$	Ch-1	0.8	2	V
			Ch-2	1.0	3	
Gate-Body Leakage	I_{GSS}	$V_{DS} = 0\text{ V}, V_{GS} = 20\text{ V}$	Ch-1		100	nA
			Ch-2		100	
Zero Gate Voltage Drain Current	I_{DSS}	$V_{DS} = 30\text{ V}, V_{GS} = 0\text{ V}$	Ch-1		1	μA
			Ch-2		100	
		$V_{DS} = 30\text{ V}, V_{GS} = 0\text{ V}, T_J = 85\text{ }^\circ\text{C}$	Ch-1		15	
			Ch-2		2000	
On-State Drain Current ^b	$I_{D(on)}$	$V_{DS} = 5\text{ V}, V_{GS} = 10\text{ V}$	Ch-1	20		A
			Ch-2	30		
Drain-Source On-State Resistance ^b	$R_{DS(on)}$		Ch-1	0.018	0.022	Ω
			Ch-2	0.0105	0.013	
			Ch-1	0.024	0.030	
			Ch-2	0.015	0.0185	
Forward Transconductance ^b	g_{fs}	$V_{DS} = 15\text{ V}, I_D = 6.3\text{ A}$	Ch-1	17		S
			Ch-2	28		
Diode Forward Voltage ^b	V_{SD}	$I_S = 1.3\text{ A}, V_{GS} = 0\text{ V}$	Ch-1	0.7	1.1	V
			Ch-2	0.47	0.5	
Dynamic^a						
Total Gate Charge	Q_g	Channel-1 $V_{DS} = 15\text{ V}, V_{GS} = 5\text{ V}, I_D = 6.3\text{ A}$	Ch-1	8.0	12	nC
			Ch-2	15	23	
Gate-Source Charge	Q_{gs}	Channel-2 $V_{DS} = 15\text{ V}, V_{GS} = 5\text{ V}, I_D = -10\text{ A}$	Ch-1	1.75		
			Ch-2	5.3		
Gate-Drain Charge	Q_{gd}		Ch-1	3.2		
			Ch-2	4.6		
Gate Resistance	R_g		Ch-1	1.5	6.1	Ω
			Ch-2	0.5	2.6	
Turn-On Delay Time	$t_{d(on)}$	Channel-1 $V_{DD} = 15\text{ V}, R_L = 15\text{ }\Omega$ $I_D \cong 1\text{ A}, V_{GEN} = 10\text{ V}, R_g = 6\text{ }\Omega$	Ch-1	10	20	ns
			Ch-2	15	30	
Rise Time	t_r		Ch-1	5	10	
			Ch-2	5	10	
Turn-Off Delay Time	$t_{d(off)}$	Channel-2 $V_{DD} = 15\text{ V}, R_L = 15\text{ }\Omega$ $I_D \cong 1\text{ A}, V_{GEN} = 10\text{ V}, R_g = 6\text{ }\Omega$	Ch-1	26	50	
			Ch-2	44	80	
Fall Time	t_f		Ch-1	8	16	
			Ch-2	12	24	
Source-Drain Reverse Recovery Time	t_{rr}	$I_F = 1.3\text{ A}, di/dt = 100\text{ A}/\mu\text{s}$	Ch-1	30	60	
			Ch-2	32	70	

Notes:

a. Guaranteed by design, not subject to production testing.

b. Pulse test; pulse width $\leq 300\text{ }\mu\text{s}$, duty cycle $\leq 2\%$.

SCHOTTKY SPECIFICATIONS $T_J = 25\text{ }^\circ\text{C}$, unless otherwise noted						
Parameter	Symbol	Test Conditions	Min.	Typ.	Max.	Unit
Forward Voltage Drop	V_F	$I_F = 1.0\text{ A}$		0.47	0.50	V
		$I_F = 1.0\text{ A}, T_J = 125\text{ }^\circ\text{C}$		0.36	0.42	
Maximum Reverse Leakage Current	I_{rm}	$V_R = 30\text{ V}$		0.004	0.100	mA
		$V_R = 30\text{ V}, T_J = 100\text{ }^\circ\text{C}$		0.7	10	
		$V_R = -30\text{ V}, T_J = 125\text{ }^\circ\text{C}$		3.0	20	
Junction Capacitance	C_T	$V_R = 10\text{ V}$		50		pF

Stresses beyond those listed under "Absolute Maximum Ratings" may cause permanent damage to the device. These are stress ratings only, and functional operation of the device at these or any other conditions beyond those indicated in the operational sections of the specifications is not implied. Exposure to absolute maximum rating conditions for extended periods may affect device reliability.

CHANNEL-1 TYPICAL CHARACTERISTICS 25 °C, unless otherwise noted

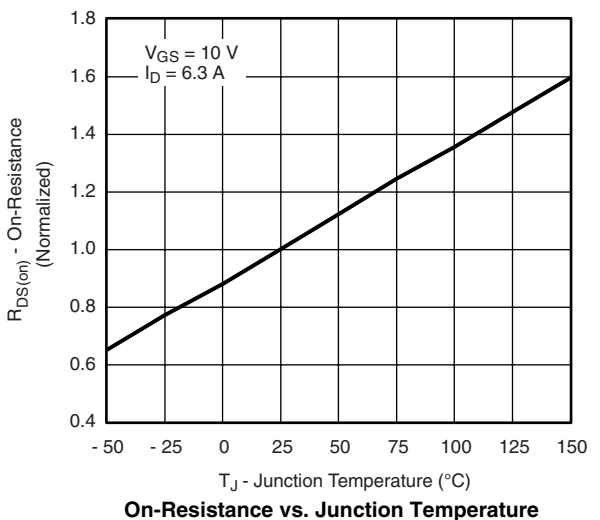
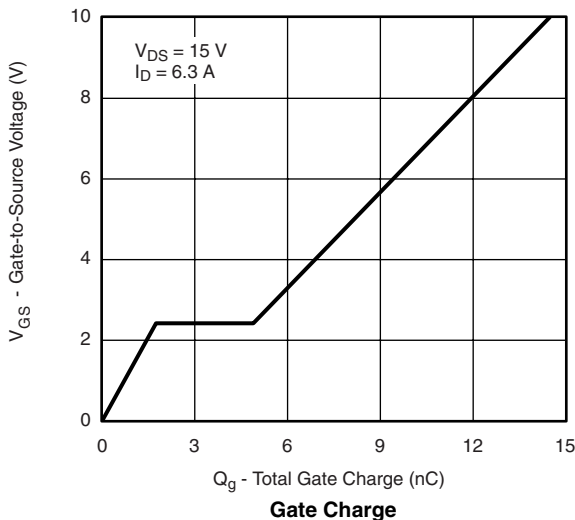
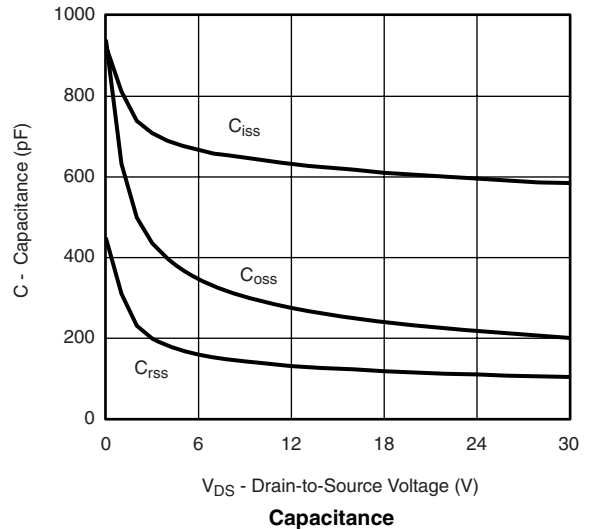
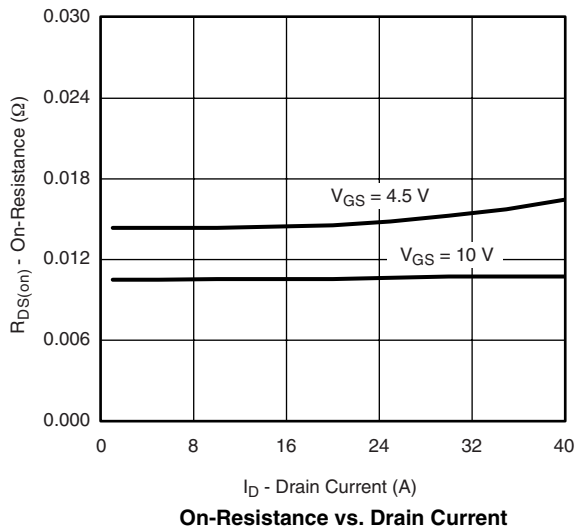
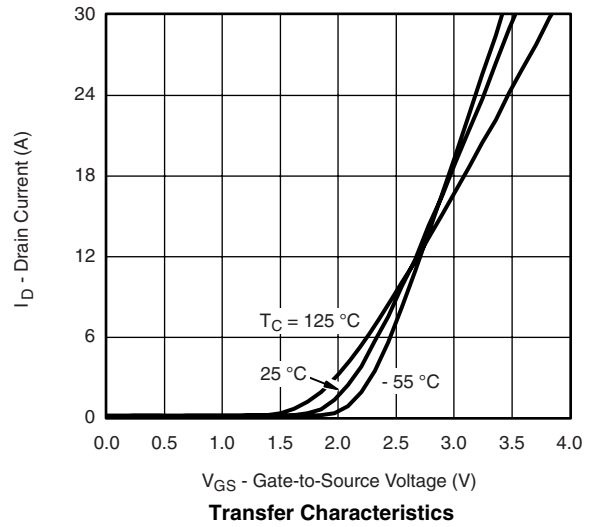
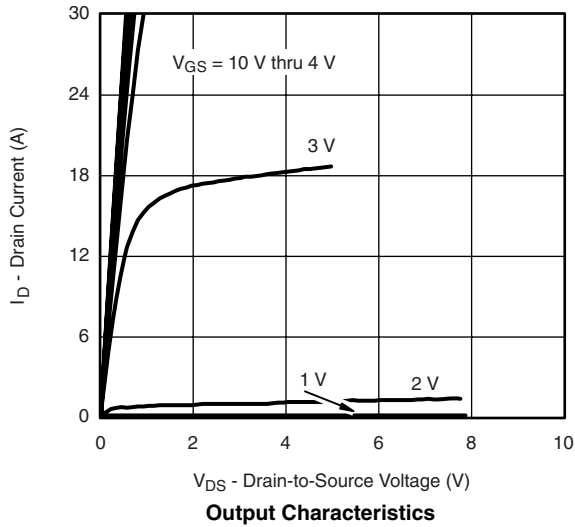

CHANNEL-1 TYPICAL CHARACTERISTICS 25 °C, unless otherwise noted

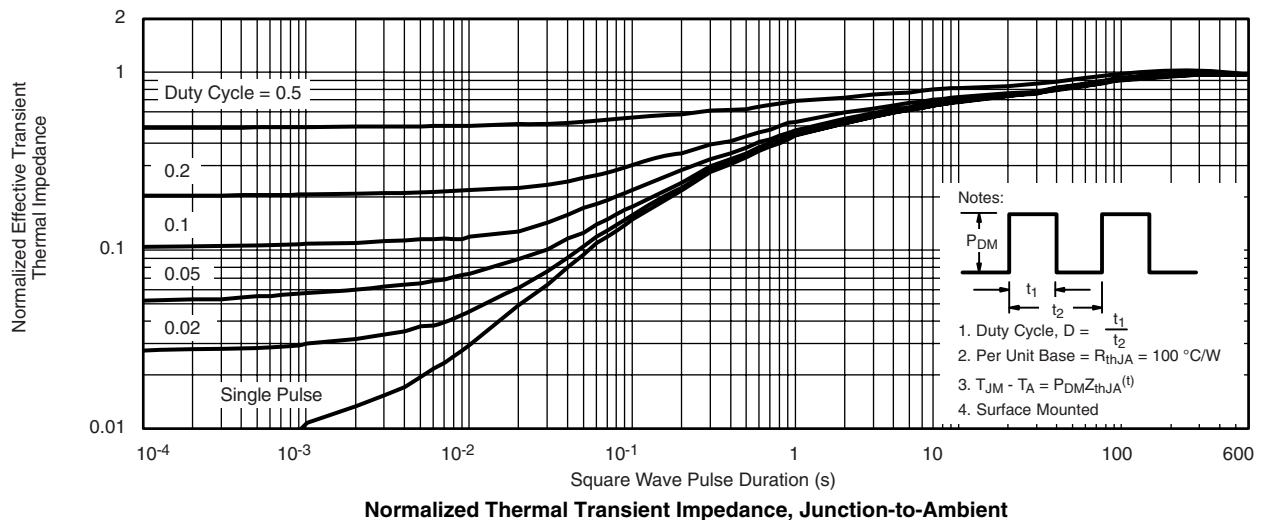
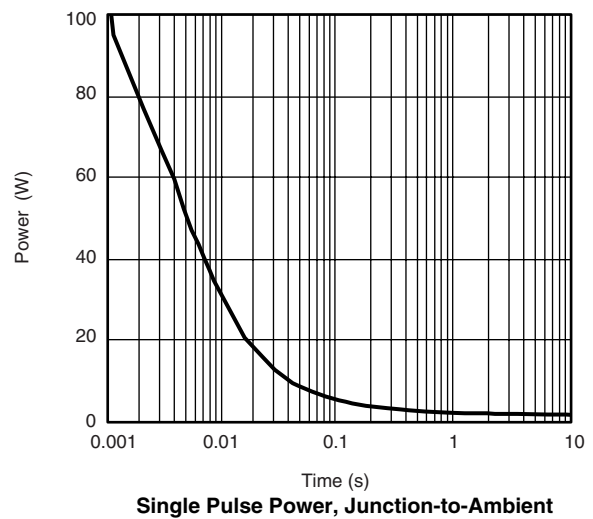
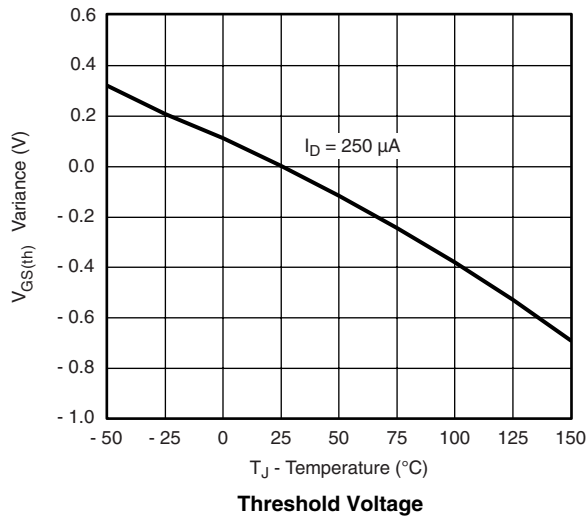
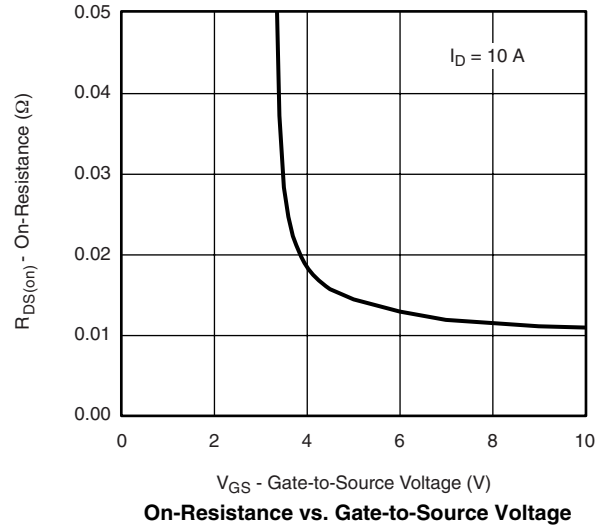
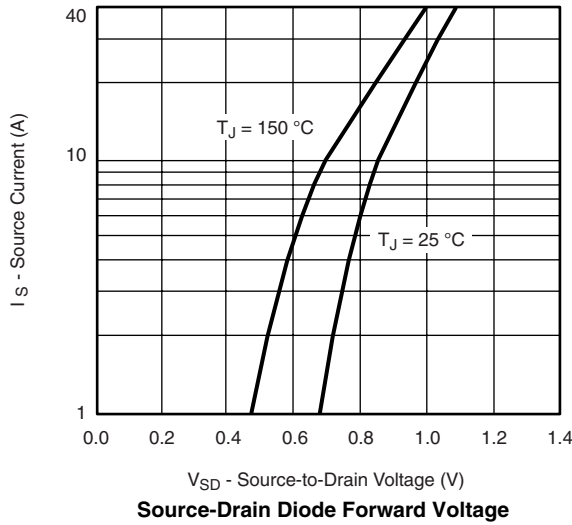

CHANNEL-1 TYPICAL CHARACTERISTICS 25 °C, unless otherwise noted

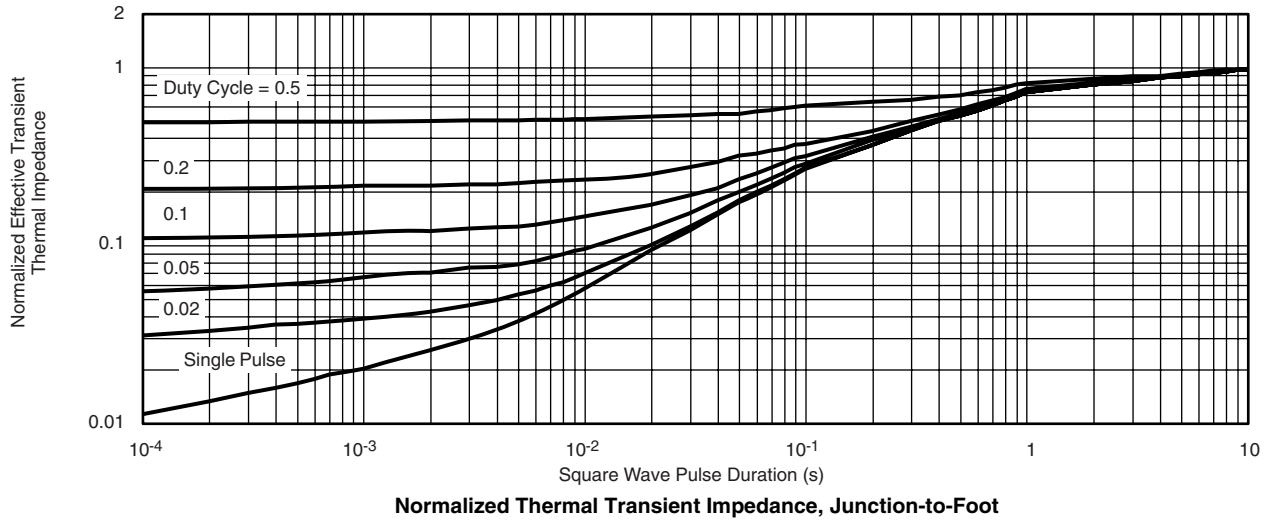

CHANNEL-2 TYPICAL CHARACTERISTICS 25 °C, unless otherwise noted

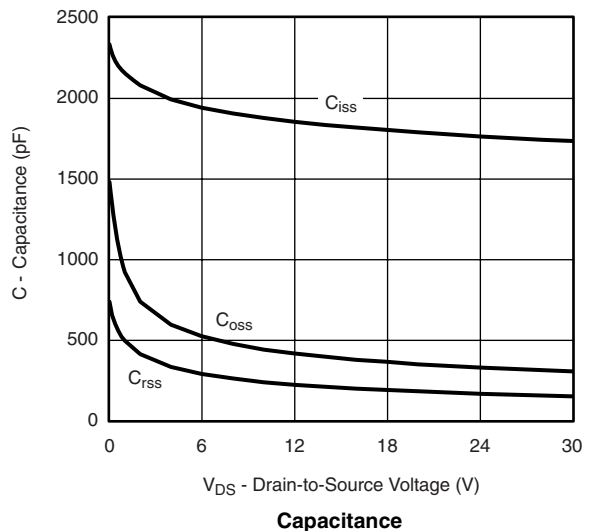
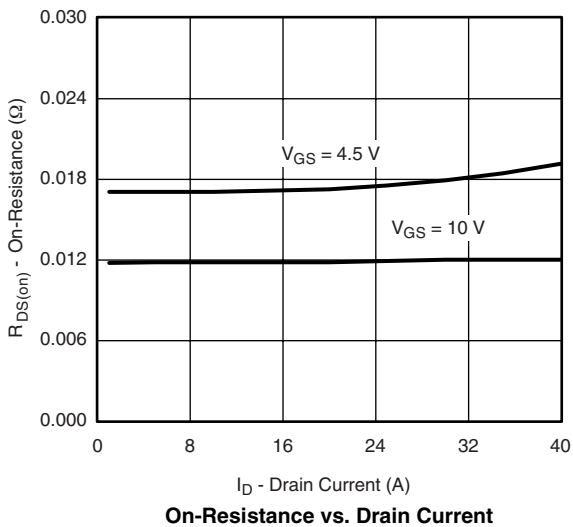
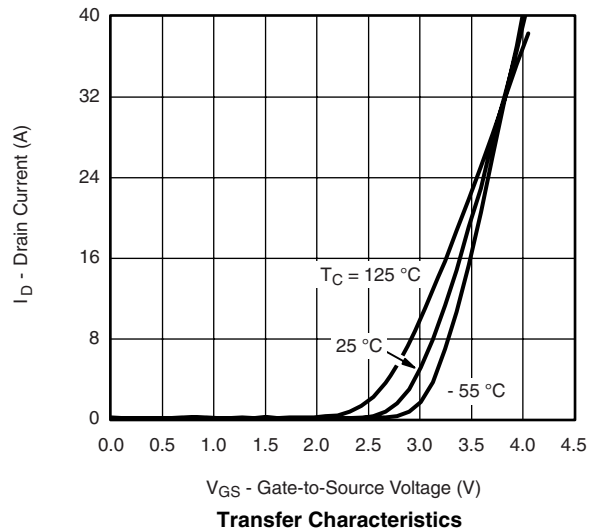
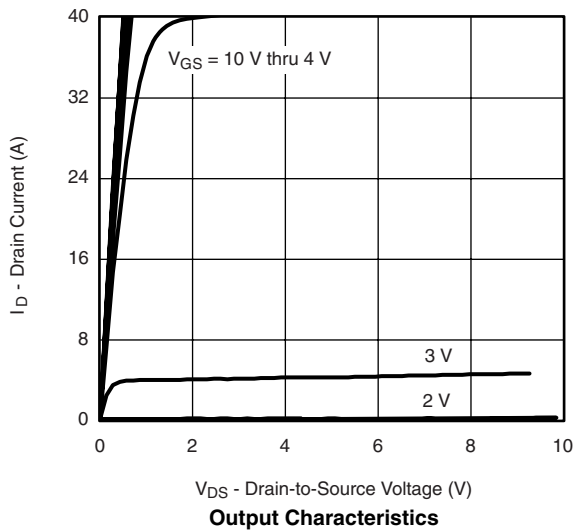

CHANNEL-2 TYPICAL CHARACTERISTICS 25 °C, unless otherwise noted

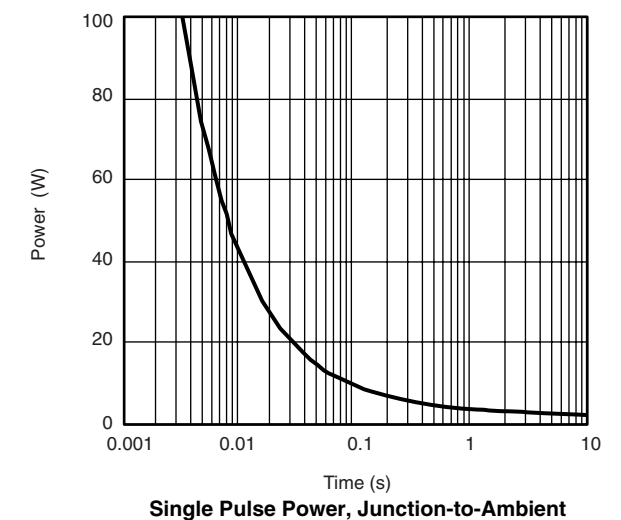
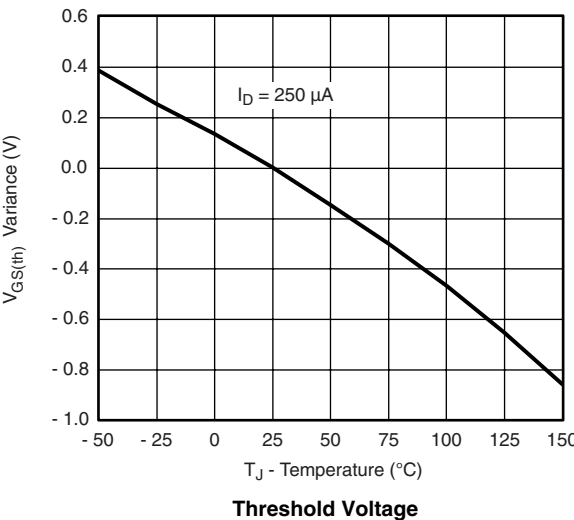
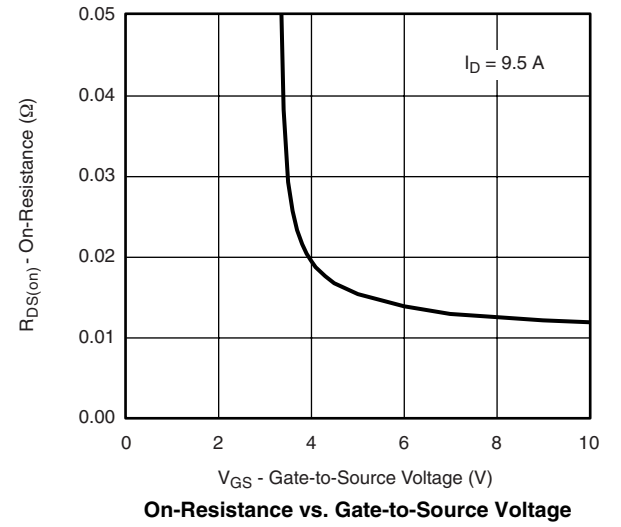
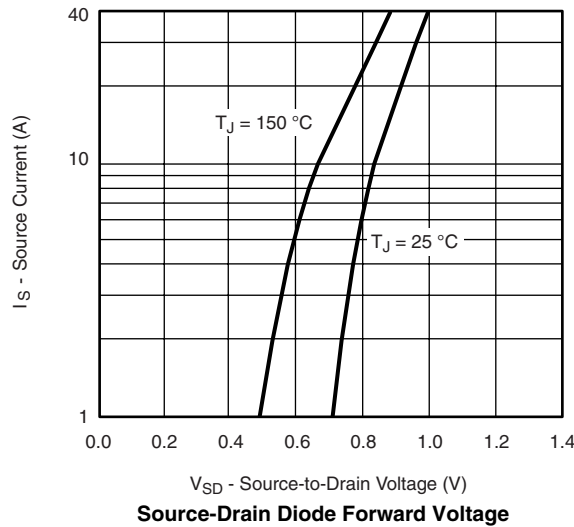
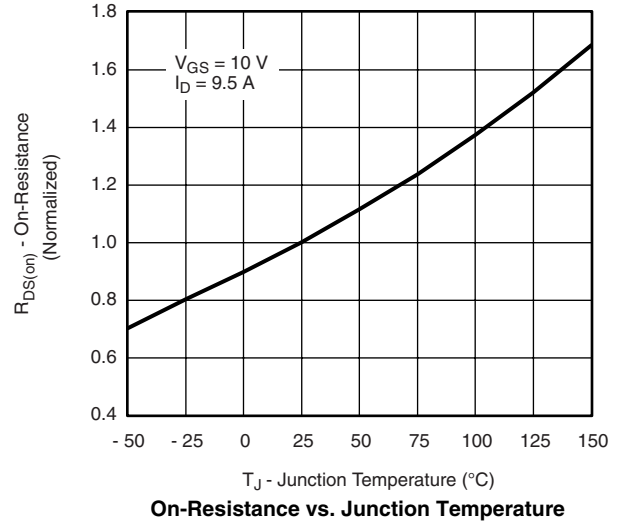
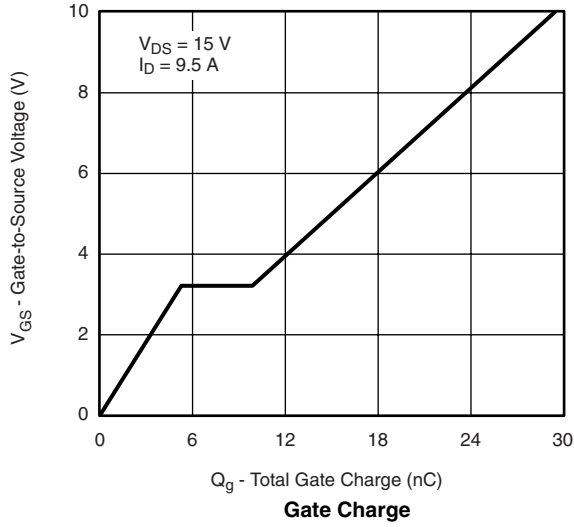

CHANNEL-2 TYPICAL CHARACTERISTICS 25 °C, unless otherwise noted

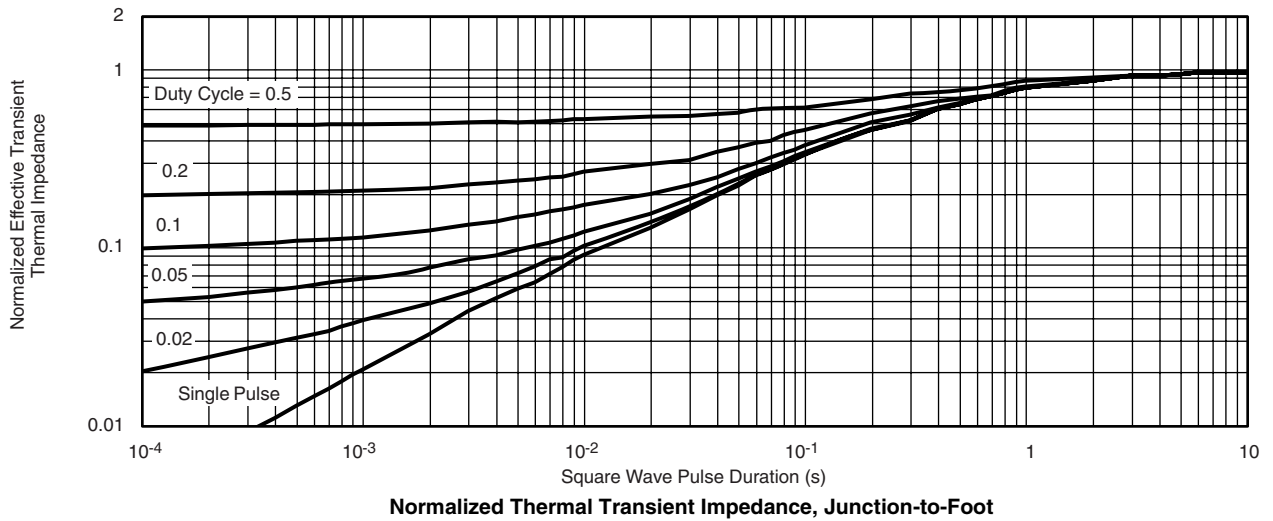
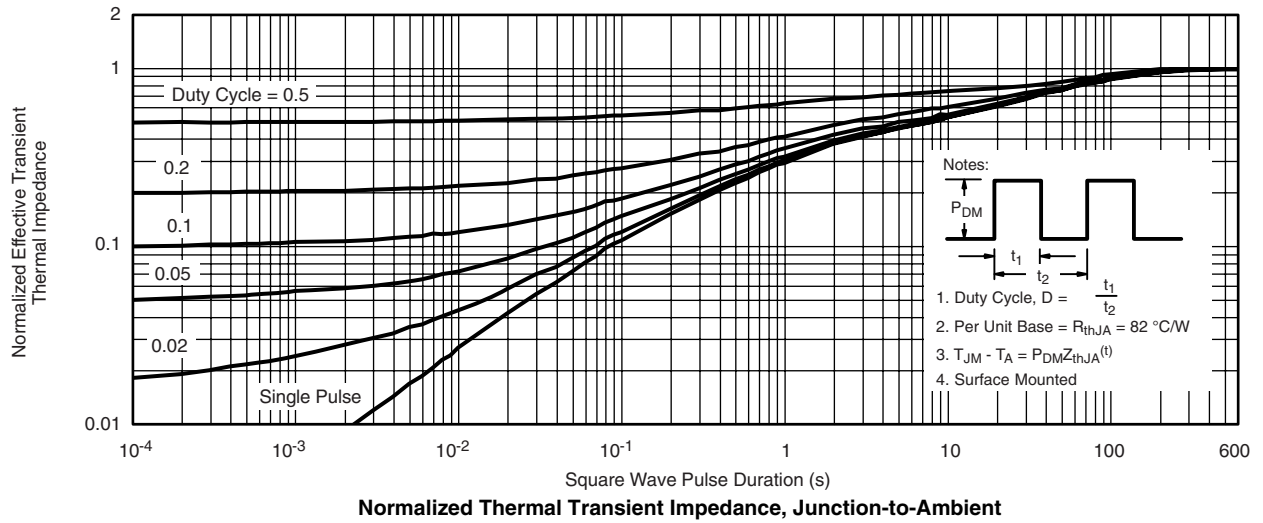

SCHOTTKY TYPICAL CHARACTERISTICS 25 °C, unless otherwise noted

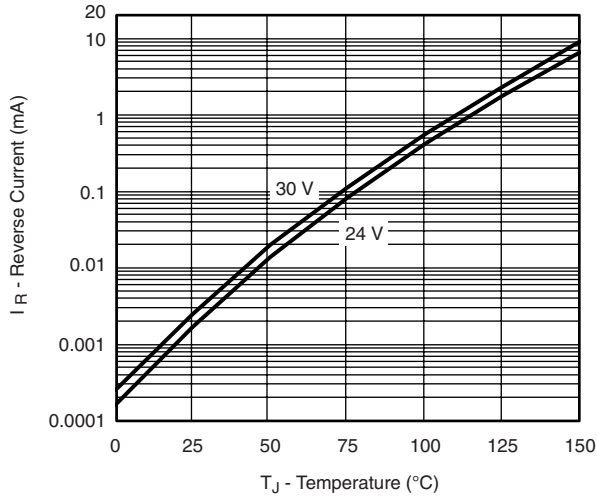

Reverse Current vs. Junction Temperature

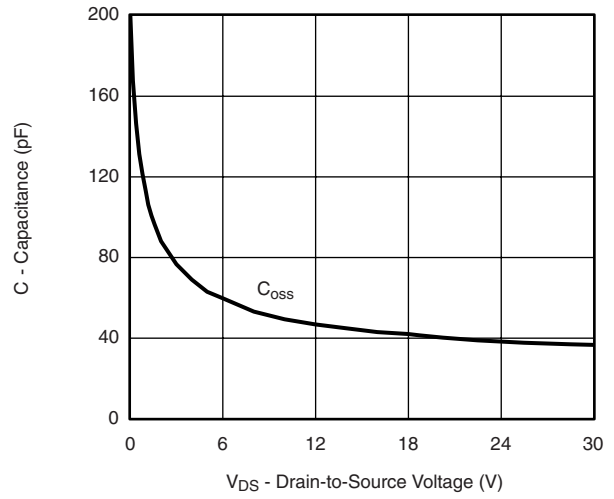

Capacitance

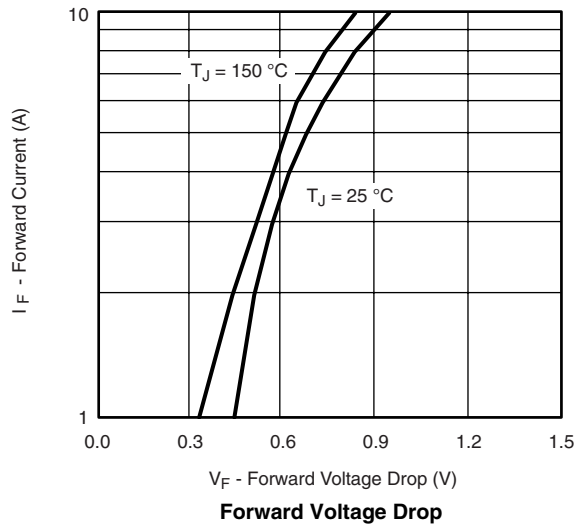

Forward Voltage Drop

Vishay Siliconix maintains worldwide manufacturing capability. Products may be manufactured at one of several qualified locations. Reliability data for Silicon Technology and Package Reliability represent a composite of all qualified locations. For related documents such as package/tape drawings, part marking, and reliability data, see www.vishay.com/ppg?71121.



Disclaimer

ALL PRODUCT, PRODUCT SPECIFICATIONS AND DATA ARE SUBJECT TO CHANGE WITHOUT NOTICE TO IMPROVE RELIABILITY, FUNCTION OR DESIGN OR OTHERWISE.

Vishay Intertechnology, Inc., its affiliates, agents, and employees, and all persons acting on its or their behalf (collectively, "Vishay"), disclaim any and all liability for any errors, inaccuracies or incompleteness contained in any datasheet or in any other disclosure relating to any product.

Vishay makes no warranty, representation or guarantee regarding the suitability of the products for any particular purpose or the continuing production of any product. To the maximum extent permitted by applicable law, Vishay disclaims (i) any and all liability arising out of the application or use of any product, (ii) any and all liability, including without limitation special, consequential or incidental damages, and (iii) any and all implied warranties, including warranties of fitness for particular purpose, non-infringement and merchantability.

Statements regarding the suitability of products for certain types of applications are based on Vishay's knowledge of typical requirements that are often placed on Vishay products in generic applications. Such statements are not binding statements about the suitability of products for a particular application. It is the customer's responsibility to validate that a particular product with the properties described in the product specification is suitable for use in a particular application. Parameters provided in datasheets and / or specifications may vary in different applications and performance may vary over time. All operating parameters, including typical parameters, must be validated for each customer application by the customer's technical experts. Product specifications do not expand or otherwise modify Vishay's terms and conditions of purchase, including but not limited to the warranty expressed therein.

Hyperlinks included in this datasheet may direct users to third-party websites. These links are provided as a convenience and for informational purposes only. Inclusion of these hyperlinks does not constitute an endorsement or an approval by Vishay of any of the products, services or opinions of the corporation, organization or individual associated with the third-party website. Vishay disclaims any and all liability and bears no responsibility for the accuracy, legality or content of the third-party website or for that of subsequent links.

Except as expressly indicated in writing, Vishay products are not designed for use in medical, life-saving, or life-sustaining applications or for any other application in which the failure of the Vishay product could result in personal injury or death. Customers using or selling Vishay products not expressly indicated for use in such applications do so at their own risk. Please contact authorized Vishay personnel to obtain written terms and conditions regarding products designed for such applications.

No license, express or implied, by estoppel or otherwise, to any intellectual property rights is granted by this document or by any conduct of Vishay. Product names and markings noted herein may be trademarks of their respective owners.