

Powered-Off Protection, 0.85 Ω , 1.8 V to 5.5 V, SPDT Analog Switch (2:1 Multiplexer)

DESCRIPTION

The DG2001E is a high performance single-pole, double-throw (SPDT) analog switch designed for 1.8 V to 5.5 V operation with a single power rail.

Fabricated with high density CMOS technology, the device achieves low on resistance of 0.85 Ω at a 5 V power supply, low power consumption, and fast switching speeds.

The DG2001E can handle both analog and digital signals and permits signals with amplitudes of up to V_+ to be transmitted in either direction. Its control logic inputs can go over V_+ up to 5.5 V. The control logic input high threshold is guaranteed as low as 1.8 V over the power supply range up to 5.5 V. It features break before make switching performance.

A powered-off protection circuit is built into the switch to prevent an abnormal current flow from COM pin to V_+ during the power-down condition. Each output pin can withstand greater than 7 kV (human body model).

Operation temperature is specified from -40 $^{\circ}\text{C}$ to +85 $^{\circ}\text{C}$. The DG2001E is available in TSOP-6 package.

FEATURES

- Low switch on-resistance (0.85 Ω)
- 1.8 V to 5.5 V single supply operation
- Isolation in powered-off mode
- Guaranteed 1.8 V logic high
- Control logic inputs can go over V_+
- Low charge injection (8 pC)
- Break before make switching
- Latch-up performance exceeds 300 mA per JESD 78
- ESD tested
 - 7000 V human body model (JS-001)
 - 1000 V charge device model (JS-002)
- Material categorization: for definitions of compliance please see www.vishay.com/doc?99912



RoHS
COMPLIANT
HALOGEN
FREE

APPLICATIONS

- Consumer and computing
- Portable instrumentation
- Medical equipment
- Battery operated systems

FUNCTIONAL BLOCK DIAGRAM AND PIN CONFIGURATION

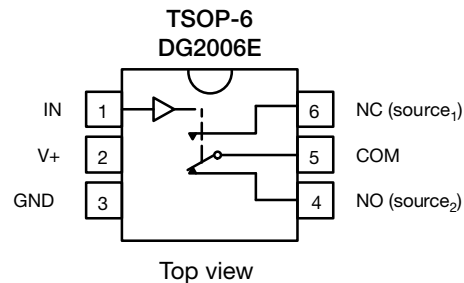
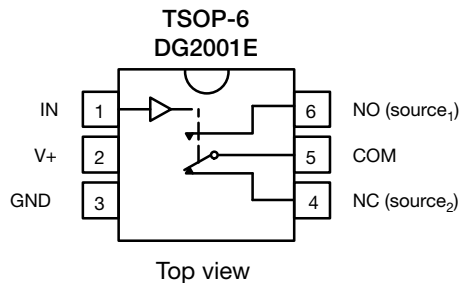

TRUTH TABLE		
LOGIC	NC	NO
0	On	Off
1	Off	On

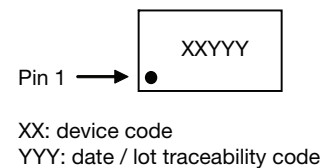

ORDERING INFORMATION			
TEMP RANGE	PACKAGE	PART NUMBER	MARKING CODE
-40 $^{\circ}\text{C}$ to +85 $^{\circ}\text{C}$	TSOP-6	DG2001EDV-T1-GE3	H1
		DG2006EDV-T1-GE3	I1



ABSOLUTE MAXIMUM RATINGS (T _A = 25 °C, unless otherwise noted)				
PARAMETER			LIMIT	UNIT
V+, COM, NC, NO, IN reference to GND			-0.3 to 6	V
Continuous current (any terminal)			± 50	mA
Peak current (pulsed at 1 ms, 10 % duty cycle)			± 200	
Storage temperature (D suffix)			-65 to +125	°C
Power dissipation (packages) ^a	TSOP-6 ^b		570	mW
ESD / HBM	JS-001		7000	V
ESD / CDM	JS-002		1000	
Latch up	Per JESD78 with 1.5 x voltage clamp		300	mA

Notes

- a. All leads welded or soldered to PC board
- b. Derate 7 mW/°C above 25 °C

Stresses beyond those listed under "Absolute Maximum Ratings" may cause permanent damage to the device. These are stress ratings only, and functional operation of the device at these or any other conditions beyond those indicated in the operational sections of the specifications is not implied. Exposure to absolute maximum rating conditions for extended periods may affect device reliability.

SPECIFICATIONS (V ₊ = 5 V)							
PARAMETER	SYMBOL	TEST CONDITIONS UNLESS OTHERWISE SPECIFIED V ₊ = 5 V, ± 10 % V _{IN} = 0.8 V or 2.4 V ^e	TEMP. ^a	LIMITS -40 °C to +85 °C			UNIT
				MIN. ^b	TYP. ^c	MAX. ^b	
Analog Switch							
Analog signal range ^d	V _{NO} , V _{NC} V _{COM}		Full	0	-	V ₊	V
On-resistance	R _{ON}	V ₊ = 4.5 V V _{COM} = 3 V, I _{NO} , I _{NC} = 10 mA	Room	-	0.85	1.6	Ω
			Full	-	-	1.8	
R _{ON} flatness ^d	R _{ON} Flatness	V ₊ = 4.5 V V _{COM} = 0 V to V ₊ , I _{NO} , I _{NC} = 10 mA	Room	-	0.3	-	
Switch off leakage current ^g	I _{NO(off)} I _{NC(off)}	V ₊ = 5.5 V V _{NO} , V _{NC} = 1 V / 4.5 V, V _{COM} = 4.5 V / 1 V	Room	-5	-	5	nA
			Full	-30	-	30	
	Room		-5	-	5		
	Full		-30	-	30		
Channel-on leakage current ^g	I _{COM(on)}	V ₊ = 5.5 V V _{NO} , V _{NC} = V _{COM} = 1 V / 4.5 V	Room	-5	-	5	
			Full	-30	-	30	
Power down leakage	I _{COM(PD)}	V ₊ = 0 V, V _{COM} = 4.5 V, V _{IN} = GND	Full ^d	-	-	1	μA
Digital Control							
Input high voltage	V _{INH}		Full	2.4	-	-	V
Input low voltage	V _{INL}		Full	-	-	0.8	
Input capacitance	C _{IN}		Full	-	3	-	pF
Input current	I _{INL} or I _{INH}	V _{IN} = 0 V or V ₊	Full	-1	-	1	μA
Dynamic Characteristics							
Turn-on time	t _{ON}	V _{NO} or V _{NC} = 3 V, R _L = 300 Ω, C _L = 35 pF	Room	-	15	32	ns
			Full	-	-	35	
Turn-off time	t _{OFF}		Room	-	6	26	
			Full	-	-	31	
Break-before-make time	t _d		Room	1	4	-	
Charge injection ^d	Q _{INJ}	C _L = 1 nF, V _{GEN} = 0 V, R _{GEN} = 0 Ω	Room	-	8	-	pC
Off-isolation ^d	OIRR	R _L = 50 Ω, C _L = 5 pF, f = 1 MHz	Room	-	-63	-	dB
Crosstalk ^d	X _{TALK}		Room	-	-63	-	
Source-off capacitance ^d	C _{NO(off)} C _{NC(off)}	V _{IN} = 0 V or V ₊ , f = 1 MHz	Room	-	16	-	pF
Channel-on capacitance ^d	C _{ON}		Room	-	53	-	
Power Supply							
Power supply current	I ₊	V _{IN} = 0 V or V ₊	Full	-	0.0003	1	μA



SPECIFICATIONS ($V_+ = 3\text{ V}$)								
PARAMETER	SYMBOL	TEST CONDITIONS UNLESS OTHERWISE SPECIFIED $V_+ = 3\text{ V}, \pm 10\%$ $V_{IN} = 0.4\text{ V}$ or 2 V^e	TEMP. ^a	LIMITS -40 °C to +85 °C			UNIT	
				MIN. ^b	TYP. ^c	MAX. ^b		
Analog Switch								
Analog signal range ^d	V_{NO}, V_{NC}, V_{COM}		Full	0	-	V_+	V	
On-resistance	R_{ON}	$V_+ = 2.7\text{ V}$ $V_{COM} = 1.5\text{ V}, I_{NO}, I_{NC} = 10\text{ mA}$	Room	-	1.6	2.2	Ω	
			Full	-	-	2.6		
R_{ON} flatness ^d	R_{ON} Flatness	$V_+ = 2.7\text{ V}$ $V_{COM} = 0\text{ V}$ to $V_+, I_{NO}, I_{NC} = 10\text{ mA}$	Room	-	0.6	-		
Switch off leakage current ^g	$I_{NO(off)}$ $I_{NC(off)}$	$V_+ = 3.3\text{ V}$ $V_{NO}, V_{NC} = 1\text{ V} / 3\text{ V}, V_{COM} = 3\text{ V} / 1\text{ V}$	Room	-5	-	5	nA	
			Full	-15	-	15		
	Room		-5	-	5			
	Full		-15	-	15			
Channel-on leakage current ^g	$I_{COM(on)}$	$V_+ = 3.3\text{ V}$ $V_{NO}, V_{NC} = V_{COM} = 1\text{ V} / 3\text{ V}$	Room	-5	-	5		
			Full	-15	-	15		
Digital Control								
Input high voltage	V_{INH}		Full	2	-	-	V	
Input low voltage	V_{INL}		Full	-	-	0.4		
Input capacitance	C_{IN}		Full	-	-	-	pF	
Input current	I_{INL} or I_{INH}	$V_{IN} = 0\text{ V}$ or V_+	Full	-1	-	1	μA	
Dynamic Characteristics								
Turn-on time	t_{ON}	V_{NO} or $V_{NC} = 2\text{ V}, R_L = 300\ \Omega, C_L = 35\text{ pF}$	Room	-	21	42	ns	
			Full	-	-	47		
Turn-off time	t_{OFF}		Room	-	9	32		
			Full	-	-	35		
Break-before-make time	t_d			Room	1	7	-	
Charge injection ^d	Q_{INJ}		$C_L = 1\text{ nF}, V_{GEN} = 0\text{ V}, R_{GEN} = 0\ \Omega$	Room	-	6	-	pC
Off-isolation ^d	OIRR		$R_L = 50\ \Omega, C_L = 5\text{ pF}, f = 1\text{ MHz}$	Room	-	-63	-	dB
Crosstalk ^d	X_{TALK}			Room	-	-63	-	
N_O, N_C off capacitance ^d	$C_{NO(off)}$ $C_{NC(off)}$		$V_{IN} = 0\text{ V}$ or $V_+, f = 1\text{ MHz}$	Room	-	16	-	pF
Channel-on capacitance ^d	C_{ON}			Room	-	54	-	
Power Supply								
Power supply current	I_+	$V_{IN} = 0\text{ V}$ or V_+	Full	-	0.00002	1	μA	



SPECIFICATIONS (V+ = 2 V)							
PARAMETER	SYMBOL	TEST CONDITIONS UNLESS OTHERWISE SPECIFIED V+ = 2 V, ± 10 % VIN = 0.4 V or 1.6 V ^e	TEMP. ^a	LIMITS -40 °C to +85 °C			UNIT
				MIN. ^b	TYP. ^c	MAX. ^b	
Analog Switch							
Analog signal range ^d	V _{NO} , V _{NC} V _{COM}		Full	0	-	V+	V
On-resistance	R _{ON}	V+ = 1.8 V V _{COM} = 1 V, I _{NO} , I _{NC} = 10 mA	Room	-	6	8	Ω
			Full	-	-	10	
R _{ON} flatness ^d	R _{ON} Flatness	V+ = 1.8 V V _{COM} = 0 V to V+, I _{NO} , I _{NC} = 10 mA	Room	-	6	-	nA
Switch off leakage current ^g	I _{NO(off)} I _{NC(off)}	V+ = 2.2 V V _{NO} , V _{NC} = 0.5 V / 1.5 V, V _{COM} = 1.5 V / 0.5 V	Room	-0.5	-	0.5	
	I _{COM(off)}		Full	-5	-	5	
Channel-on leakage current ^g	I _{COM(on)}	V+ = 2.2 V V _{NO} , V _{NC} = V _{COM} = 0.5 V / 1.5 V	Room	-0.5	-	0.5	
			Full	-5	-	5	
Digital Control							
Input high voltage	V _{INH}		Full	1.6	-	-	V
Input low voltage	V _{INL}		Full	-	-	0.4	
Input capacitance	C _{IN}		Full	-	3	-	pF
Input current	I _{INL} or I _{INH}	V _{IN} = 0 V or V+	Full	-1	-	1	μA
Dynamic Characteristics							
Turn-on time	t _{ON}	V _{NO} or V _{NC} = 1.5 V, R _L = 300 Ω, C _L = 35 pF	Room	-	36	51	ns
			Full	-	-	62	
Turn-off time	t _{OFF}		Room	-	16	40	
			Full	-	-	43	
Break-before-make time	t _d		Room	1	16	-	
Charge injection ^d	Q _{INJ}	C _L = 1 nF, V _{GEN} = 0 V, R _{GEN} = 0 Ω	Room	-	21	-	pC
Off-isolation ^d	OIRR	R _L = 50 Ω, C _L = 5 pF, f = 1 MHz	Room	-	-63	-	dB
Crosstalk ^d	X _{TALK}		Room	-	-63	-	
N _O , N _C off capacitance ^d	C _{NO(off)} C _{NC(off)}	V _{IN} = 0 V or V+, f = 1 MHz	Room	-	16	-	pF
Channel-on capacitance ^d	C _{ON}		Room	-	52	-	
Power Supply							
Power supply current	I+	V _{IN} = 0 V or V+	Full	-	0.00001	1	μA

Notes

- a. Room = 25 °C, full = as determined by the operating suffix
- b. The algebraic convention whereby the most negative value is a minimum and the most positive a maximum, is used in this datasheet
- c. Typical values are for design aid only, not guaranteed nor subject to production testing
- d. Guarantee by design, nor subjected to production test
- e. V_{IN} = input voltage to perform proper function
- f. Guaranteed by 5 V leakage testing, not production tested



TYPICAL CHARACTERISTICS (25 °C, unless otherwise noted)

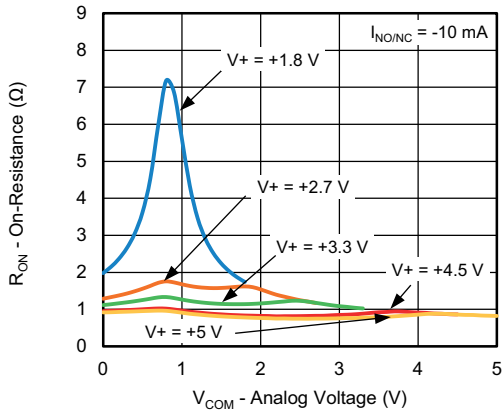

R_{DS(on)} vs. V_{COM} and Supply Voltage

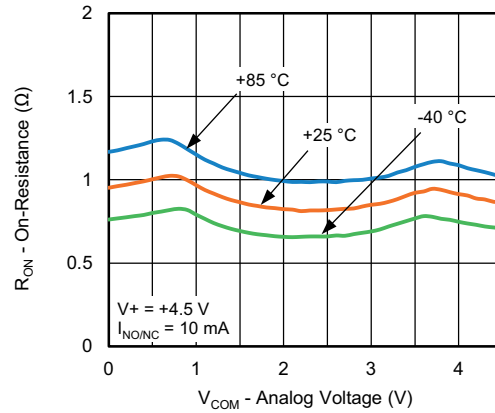

R_{DS(on)} vs. V_{COM} and Temperature

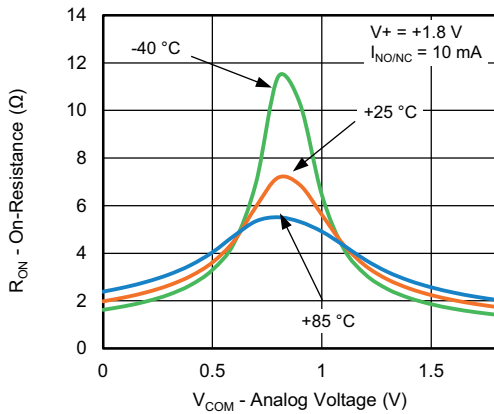

R_{DS(on)} vs. V_{COM} and Temperature

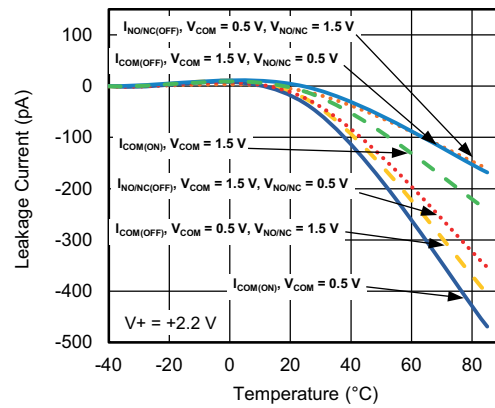

Leakage Current vs. Temperature

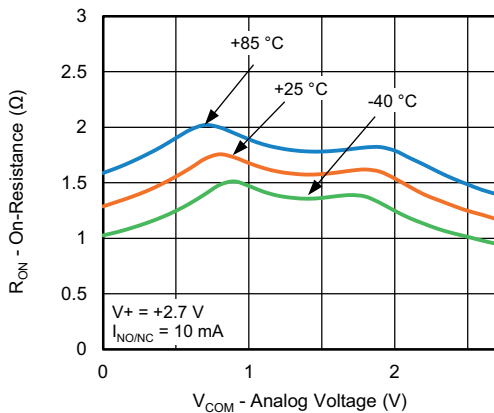

R_{DS(on)} vs. V_{COM} and Temperature

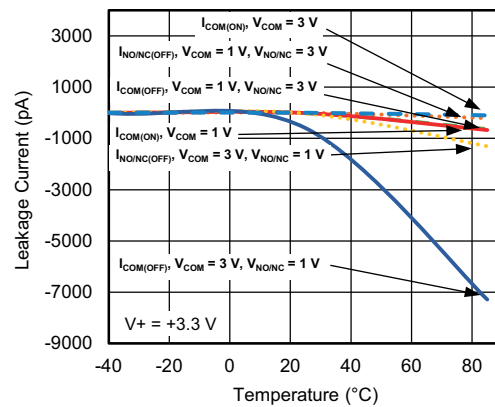

Leakage Current vs. Temperature

TYPICAL CHARACTERISTICS (25 °C, unless otherwise noted)

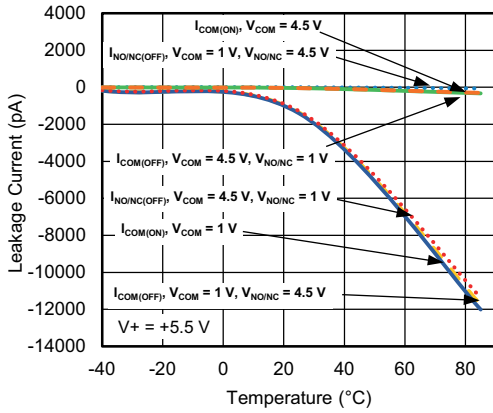

Leakage Current vs. Temperature

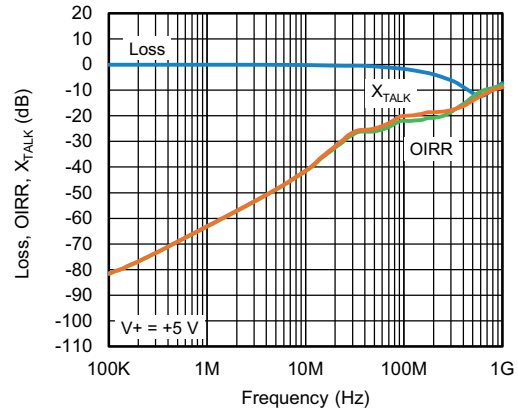

Insertion Loss, Off-Isolation Crosstalk vs. Frequency

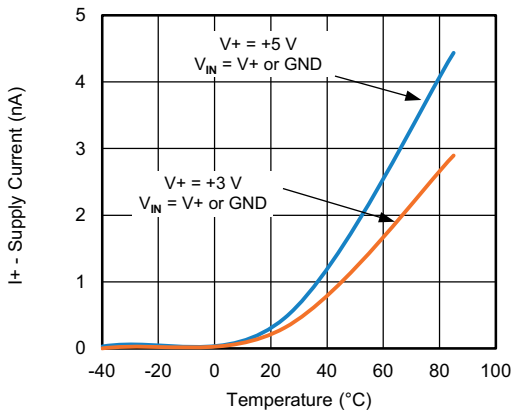

Supply Current vs. Temperature

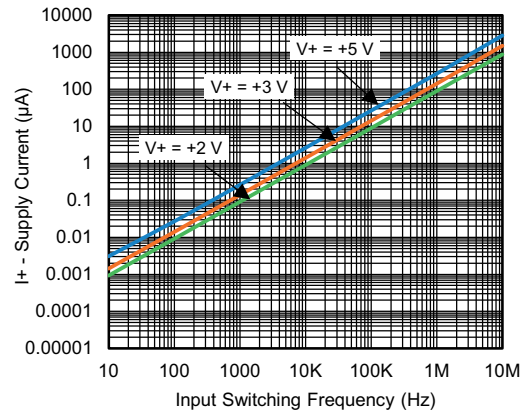

Supply Current vs. Input Switching Frequency

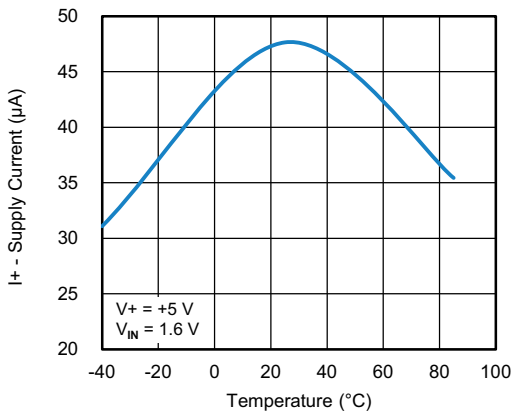

Supply Current vs. Temperature

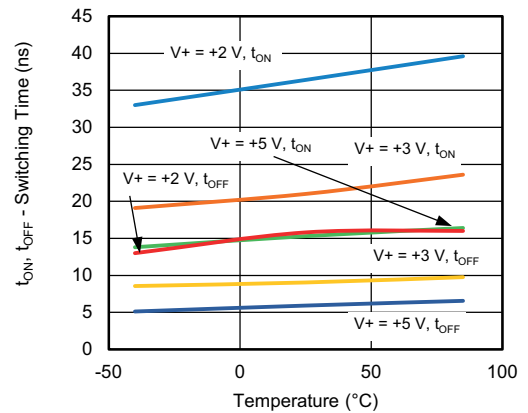

Switching Time vs. Temperature and Supply Voltage



TYPICAL CHARACTERISTICS (25 °C, unless otherwise noted)

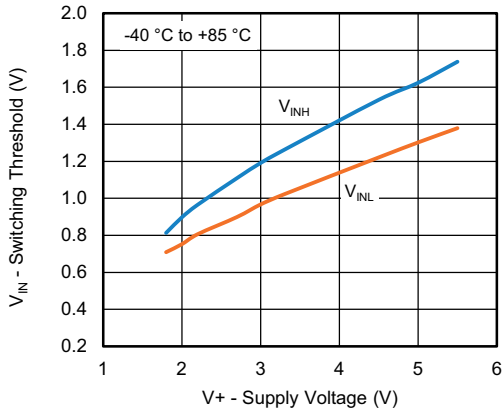

Switching Threshold vs. Supply Voltage

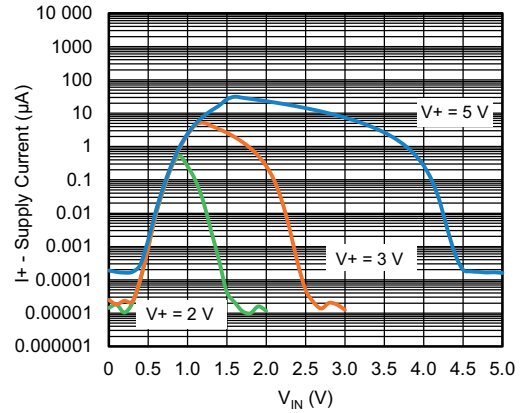

Supply Current vs. Enable Input Voltage

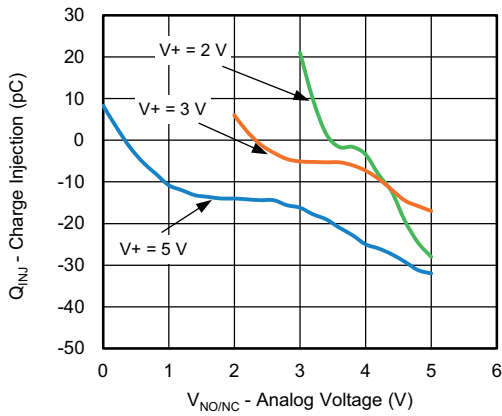

Charge Injection vs. Analog Voltage

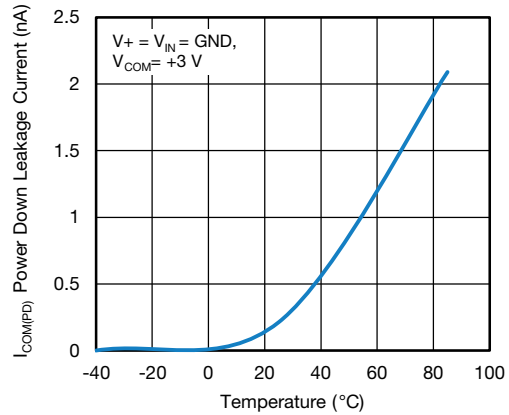

Power Down Leakage Current vs. Temperature

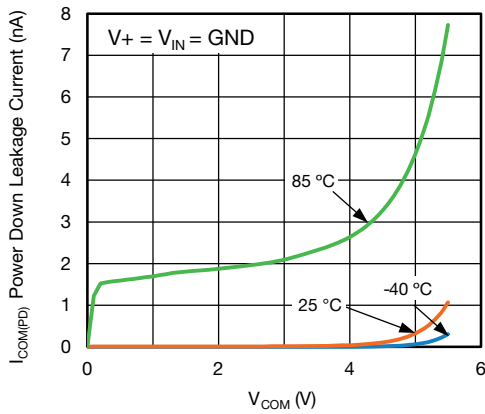

Power Down Leakage Current vs. V_{COM}

TEST CIRCUITS

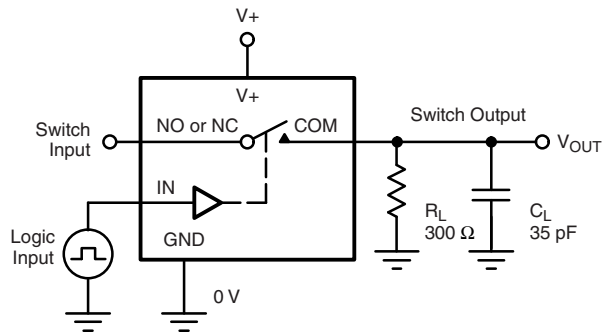

C_L (includes fixture and stray capacitance)

$$V_{OUT} = V_{COM} \left(\frac{R_L}{R_L + R_{ON}} \right)$$

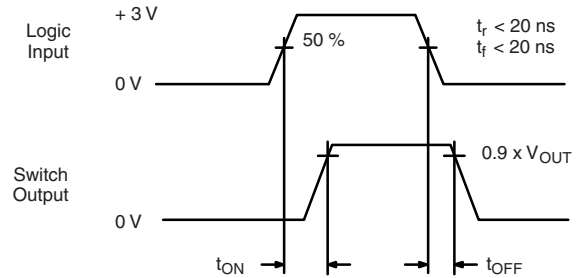

Logic "1" = Switch On
Logic input waveforms inverted for switches that have the opposite logic sense.

Fig. 1 - Switching Time

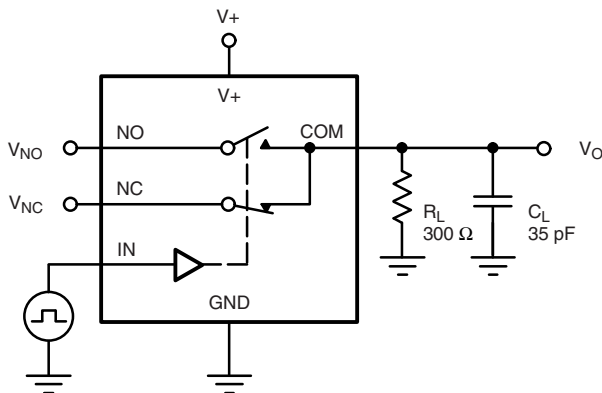

C_L (includes fixture and stray capacitance)

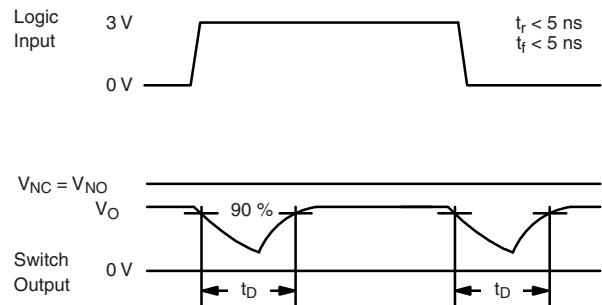
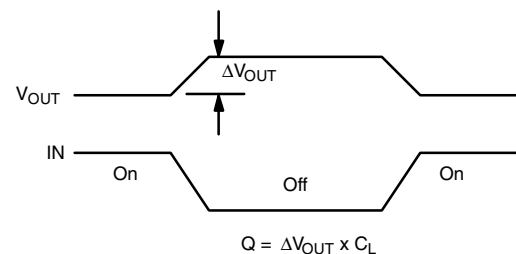
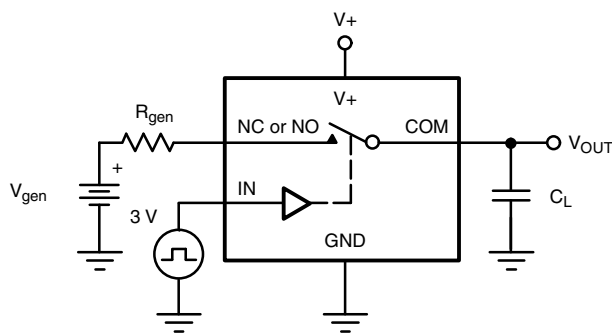

Fig. 2 - Break-Before-Make Interval



IN depends on switch configuration: input polarity determined by sense of switch.

Fig. 3 - Charge Injection

TEST CIRCUITS

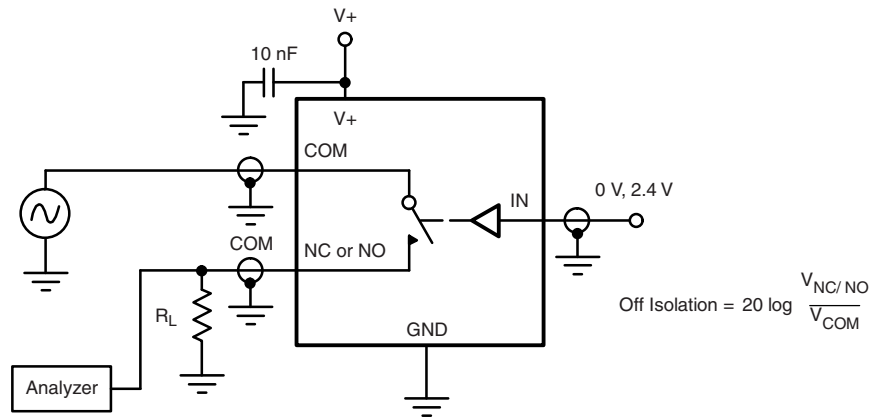

Fig. 4 - Off-Isolation

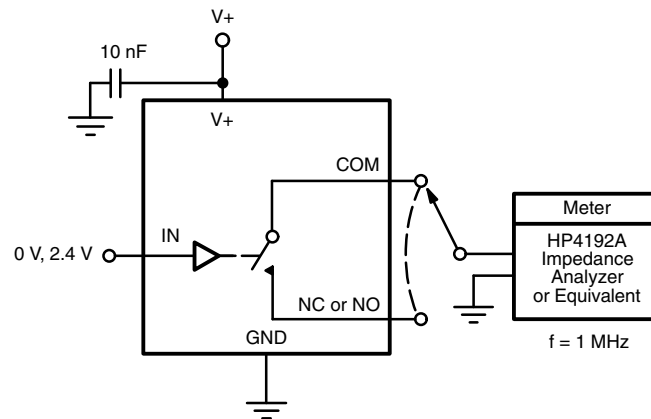

Fig. 5 - Channel Off / On Capacitance



PRODUCT SUMMARY	
Part number	DG2001E
Status code	2
Configuration	SPDT x 1
Single supply min. (V)	1.8
Single supply max. (V)	5.5
Dual supply min. (V)	-
Dual supply max. (V)	-
On-resistance (Ω)	0.85
Charge injection (pC)	8
Source on capacitance (pF)	53
Source off capacitance (pF)	16
Leakage switch on typ. (nA)	0.05
Leakage switch off max. (nA)	5
-3 dB bandwidth (MHz)	-
Package	TSOP-6
Functional circuit / applications	Multi purpose, instrumentation, medical and healthcare, portable
Interface	Binary
Single supply operation	Yes
Dual supply operation	-
Turn on time max. (ns)	32
Crosstalk and off isolation	-63

Vishay Siliconix maintains worldwide manufacturing capability. Products may be manufactured at one of several qualified locations. Reliability data for Silicon Technology and Package Reliability represent a composite of all qualified locations. For related documents such as package / tape drawings, part marking, and reliability data, see www.vishay.com/ppg?76471.

TSOP: 5/6-LEAD

JEDEC Part Number: MO-193C

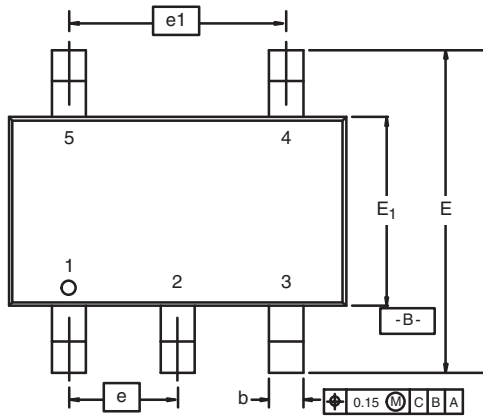

5-LEAD TSOP

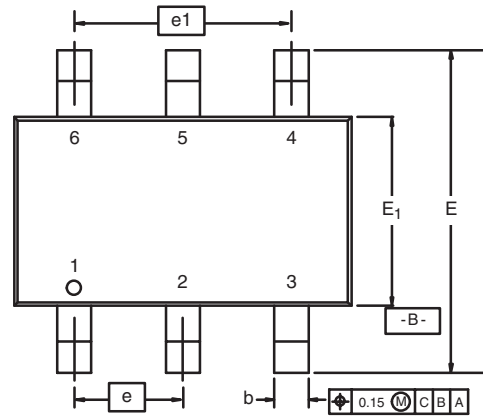

6-LEAD TSOP

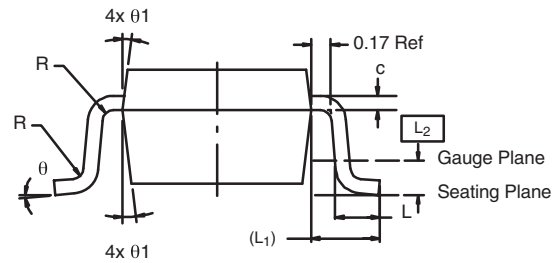
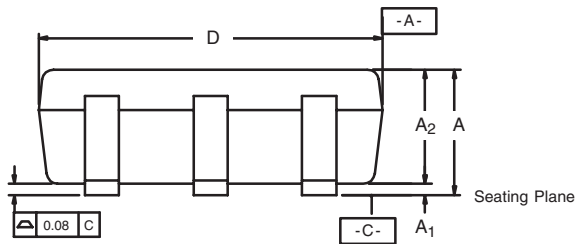

Dim	MILLIMETERS			INCHES		
	Min	Nom	Max	Min	Nom	Max
A	0.91	-	1.10	0.036	-	0.043
A₁	0.01	-	0.10	0.0004	-	0.004
A₂	0.90	-	1.00	0.035	0.038	0.039
b	0.30	0.32	0.45	0.012	0.013	0.018
c	0.10	0.15	0.20	0.004	0.006	0.008
D	2.95	3.05	3.10	0.116	0.120	0.122
E	2.70	2.85	2.98	0.106	0.112	0.117
E₁	1.55	1.65	1.70	0.061	0.065	0.067
e	0.95 BSC			0.0374 BSC		
e₁	1.80	1.90	2.00	0.071	0.075	0.079
L	0.32	-	0.50	0.012	-	0.020
L₁	0.60 Ref			0.024 Ref		
L₂	0.25 BSC			0.010 BSC		
R	0.10	-	-	0.004	-	-
θ	0°	4°	8°	0°	4°	8°
θ₁	7° Nom			7° Nom		
ECN: C-06593-Rev. I, 18-Dec-06						
DWG: 5540						



Recommended Land Pattern For TSOP-5L / TSOP-6L

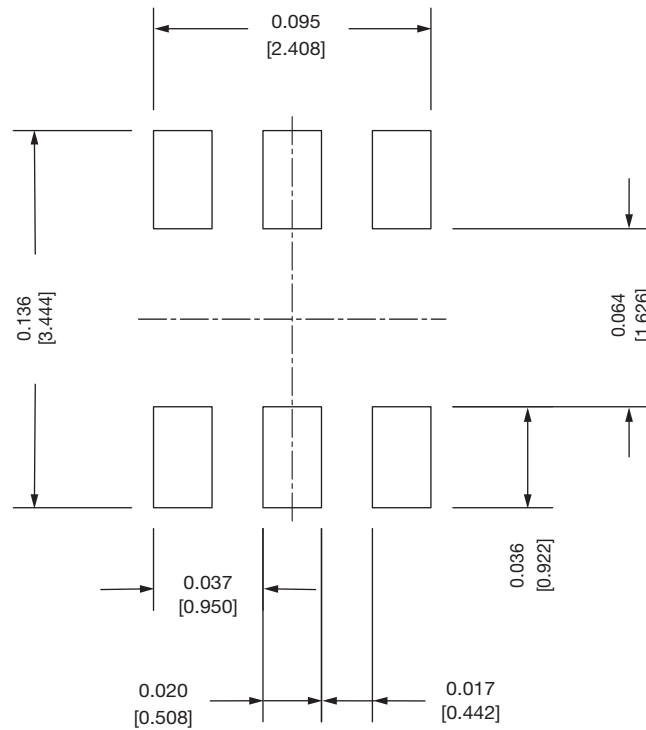
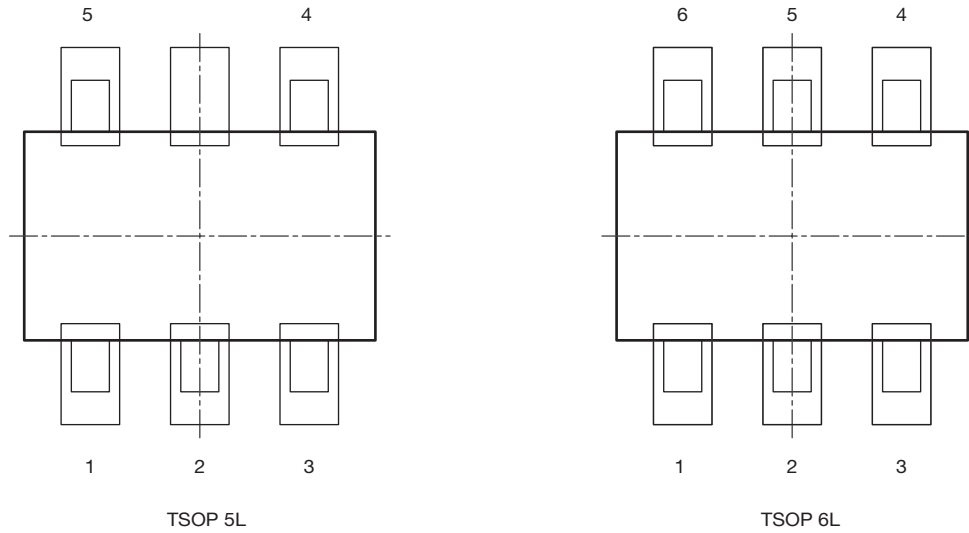

Note

- All dimensions are in inches (millimeter)

ECN: C22-0860-Rev. B, 24-Oct-2022
 DWG: 3010



Disclaimer

ALL PRODUCT, PRODUCT SPECIFICATIONS AND DATA ARE SUBJECT TO CHANGE WITHOUT NOTICE TO IMPROVE RELIABILITY, FUNCTION OR DESIGN OR OTHERWISE.

Vishay Intertechnology, Inc., its affiliates, agents, and employees, and all persons acting on its or their behalf (collectively, "Vishay"), disclaim any and all liability for any errors, inaccuracies or incompleteness contained in any datasheet or in any other disclosure relating to any product.

Vishay makes no warranty, representation or guarantee regarding the suitability of the products for any particular purpose or the continuing production of any product. To the maximum extent permitted by applicable law, Vishay disclaims (i) any and all liability arising out of the application or use of any product, (ii) any and all liability, including without limitation special, consequential or incidental damages, and (iii) any and all implied warranties, including warranties of fitness for particular purpose, non-infringement and merchantability.

Statements regarding the suitability of products for certain types of applications are based on Vishay's knowledge of typical requirements that are often placed on Vishay products in generic applications. Such statements are not binding statements about the suitability of products for a particular application. It is the customer's responsibility to validate that a particular product with the properties described in the product specification is suitable for use in a particular application. Parameters provided in datasheets and / or specifications may vary in different applications and performance may vary over time. All operating parameters, including typical parameters, must be validated for each customer application by the customer's technical experts. Product specifications do not expand or otherwise modify Vishay's terms and conditions of purchase, including but not limited to the warranty expressed therein.

Hyperlinks included in this datasheet may direct users to third-party websites. These links are provided as a convenience and for informational purposes only. Inclusion of these hyperlinks does not constitute an endorsement or an approval by Vishay of any of the products, services or opinions of the corporation, organization or individual associated with the third-party website. Vishay disclaims any and all liability and bears no responsibility for the accuracy, legality or content of the third-party website or for that of subsequent links.

Vishay products are not designed for use in life-saving or life-sustaining applications or any application in which the failure of the Vishay product could result in personal injury or death unless specifically qualified in writing by Vishay. Customers using or selling Vishay products not expressly indicated for use in such applications do so at their own risk. Please contact authorized Vishay personnel to obtain written terms and conditions regarding products designed for such applications.

No license, express or implied, by estoppel or otherwise, to any intellectual property rights is granted by this document or by any conduct of Vishay. Product names and markings noted herein may be trademarks of their respective owners.