













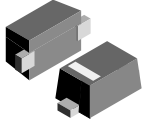
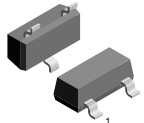
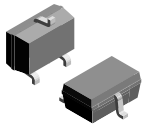
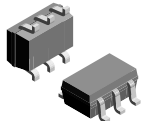
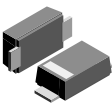

Package Dimensions for ESD -, Zener -, Small Signal Switching -, and Schottky Diodes

PACKAGE	PAGE
CLP0603-2L	3
CLP1006-2L	4
CLP1406-2L	5
CLP1608-2L	6
CLP0603-2M	7
CLP1007-5L	8
DFN1006-2A	9
DFN1110-3A	10
LLP1006-2L	11
LLP1006-2M	12

PACKAGE	PAGE
LLP1006-3L	13
LLP1010-5L	14
LLP1010-6M	15
LLP1713-7L	16
LLP1713-9L	17
LLP2513-13L	18
LLP3313-17L	19
LLP75-4L	20
LLP75-6L	21
LLP75-7L	22

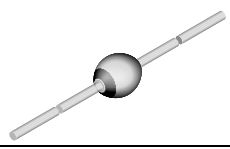
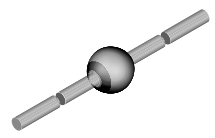

PACKAGE		PAGE
SOD-123		23
SOD-323		24
SOD-523		25
SOT-23		26
SOT-323		27
SOT-363		28
SMF (DO-219AB)		29
SMA (DO-214AC)		30
MELF DO-213AB (Plastic)		31
MELF DO-213AB (Glass)		32
MicroMELF		33

PACKAGE		PAGE
MicroSMF (DO-219-AC)		34
MiniMELF (SOD-80)		35
QuadroMELF (SOD-80)		36
DO-35 (DO-204AH)		37
DO-35_2		37
DO-41 (DO-204AL) (glass)		37
SOD-57		38
SOD-64		38



CLP0603-2L PACKAGE DIMENSIONS in millimeters (inches)

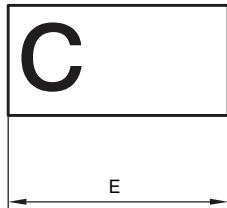
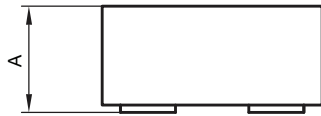
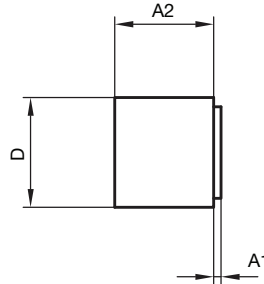
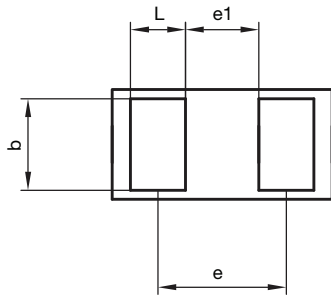

	mm			mils		
	min.	nom.	max.	min.	nom.	max.
A	0.25	0.28	0.30	9.84	11.02	11.81
A1	0.01	0.01	0.02	0.39	0.39	0.79
A2	0.24	0.27	0.28	9.54	10.63	11.02
b	0.22	0.25	0.28	8.66	9.84	11.02
D	0.27	0.30	0.33	10.62	11.81	12.99
E	0.57	0.60	0.63	22.44	23.62	24.80
e		0.40			15.75	
e1		0.25			9.84	
L	0.12	0.15	0.18	4.72	5.91	7.09

foot print recommendation:

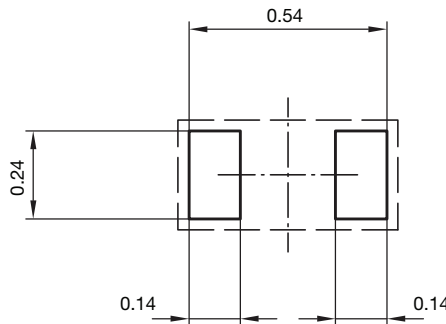

Document no.:S8-V-3906.04-023 (4)
Created - Date: 22. Nov. 2010
Rev.9 - Date: 15. Feb. 2017

[< back](#)



CLP1006-2L PACKAGE DIMENSIONS in millimeters (inches)

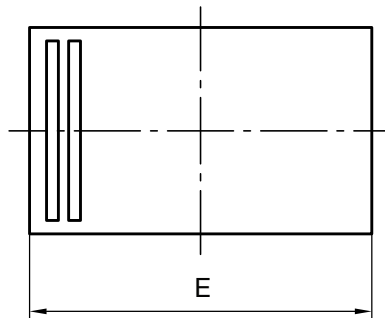
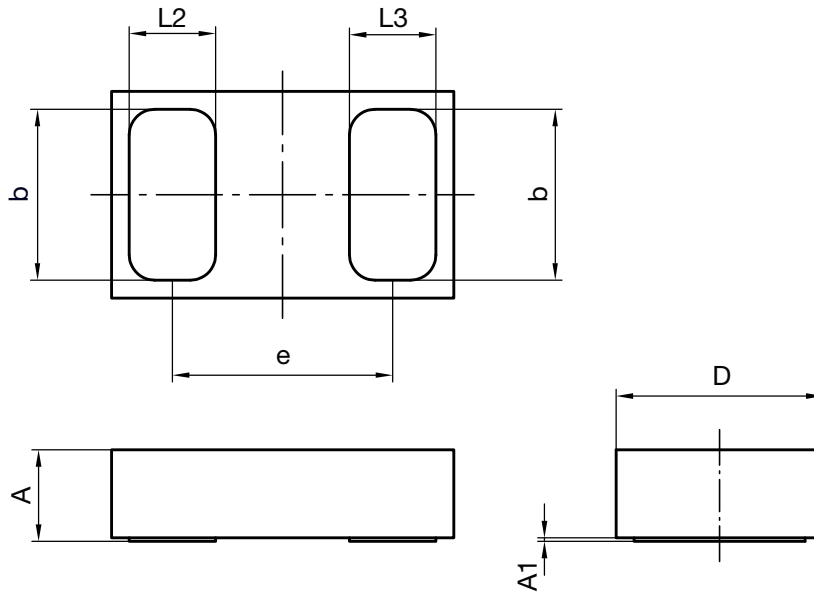

	min.	max.
A	0.25	0.29
A1		0.02
b	0.48	0.53
D	0.59	0.63
E	0.99	1.03
e	0.65	
L2	0.23	0.28
L3	0.23	0.28

foot print recommendation:

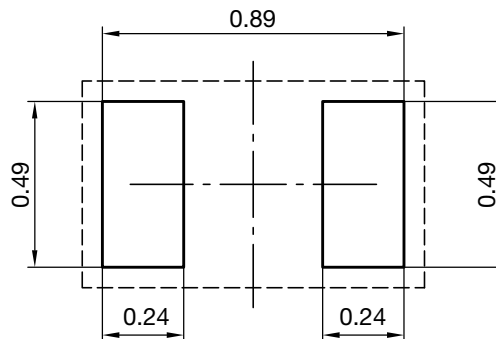

Document no.:S8-V-3906.04-039 (4)
 Created - Date: 02. April 2015
 Rev.2 - Date: 03. Feb. 2016

[< back](#)



CLP1406-2L PACKAGE DIMENSIONS in millimeters (inches)

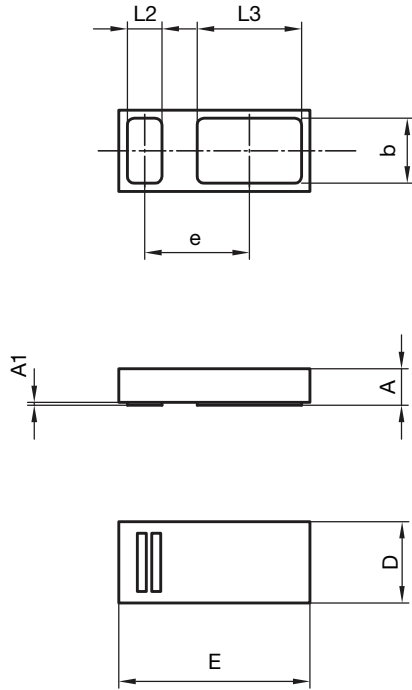

	min.	max.
A	0.25	0.29
A1		0.02
b	0.46	0.50
D	0.59	0.63
E	1.39	1.43
e	0.77	
L2	0.23	0.27
L3	0.75	0.79

foot print recommendation:

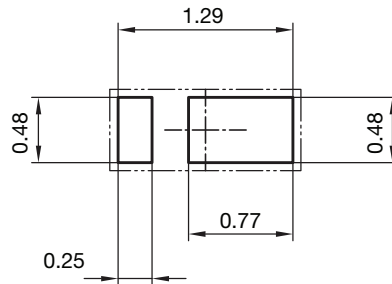

Document no.:S8-V-3906.04-045 (4)
Created - Date: 22. Jan. 2016

[< back](#)



CLP1608-2L PACKAGE DIMENSIONS in millimeters (inches)

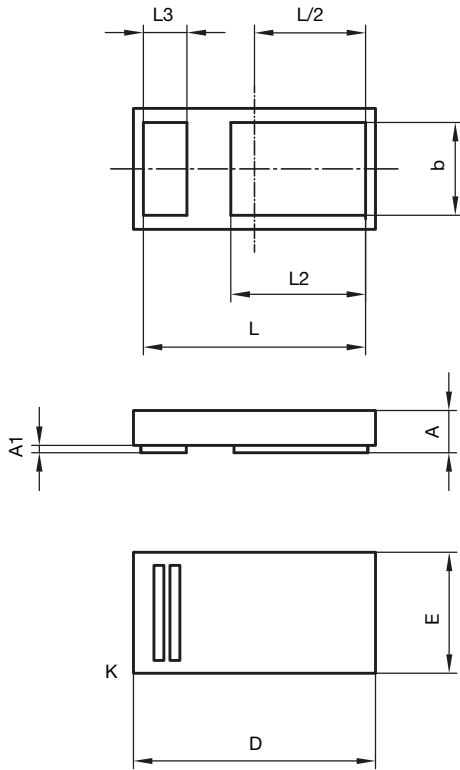

		A	A1	b	D	E	L	L2	L3
mm	min.	0.25		0.58	1.55	0.75	1.42	0.85	0.25
	max.	0.29	0.02	0.65	1.65	0.85	1.52	0.93	0.33

foot print recommendation:

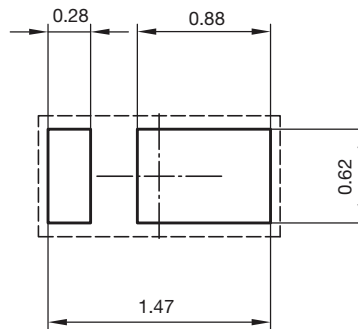

Document no.:S8-V-3906.04-033 (4)
 Created - Date: 10. Feb. 2014
 Rev.4 - Date: 02. July. 2019

[< back](#)



CLP0603-2M PACKAGE DIMENSIONS in millimeters (inches)

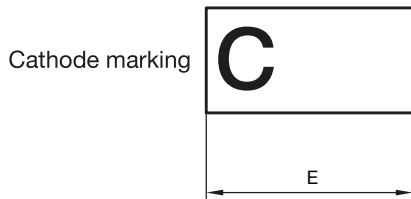
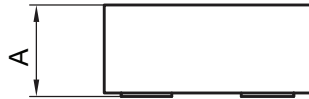
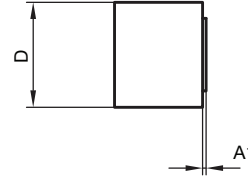
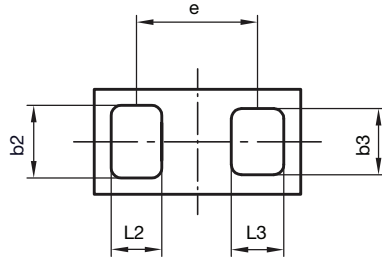

	min.	max.
A	0.25	0.29
A1		0.02
b2	0.19	0.24
b3	0.17	0.22
D	0.29	0.33
E	0.59	0.63
e	0.40	
L2	0.10	0.15
L3	0.10	0.15

foot print recommendation:

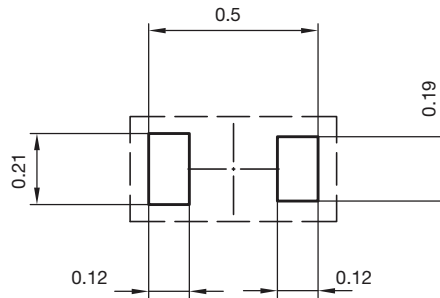

Document no.:S8-V-3906.04-038 (4)
Created - Date: 01. April 2015
Rev.3 - Date: 15. Feb. 2017

[< back](#)



CLP1007-5L PACKAGE DIMENSIONS in millimeters

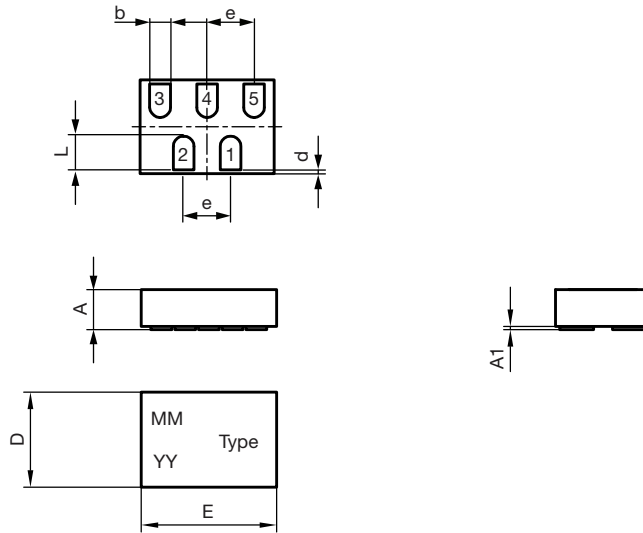

	Millimeters	
	min.	max.
A	0.25	0.29
A1	-	0.02
b	0.13	0.17
D	0.68	0.73
E	0.98	1.03
e	0.35	
L	0.23	0.27
Radius	0.075	
d	0.03	

foot print recommendation:

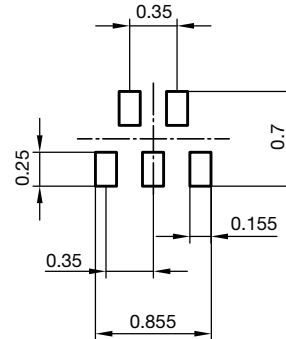

Document no.: S8-V-3906.04-041 (4)
 Created - Date: 11-Aug- 2015
 Rev. 1 - Date: 30-Jul-2019

[< back](#)



DFN1006-2A PACKAGE DIMENSIONS in millimeters (inches)

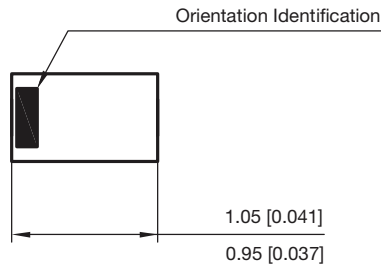
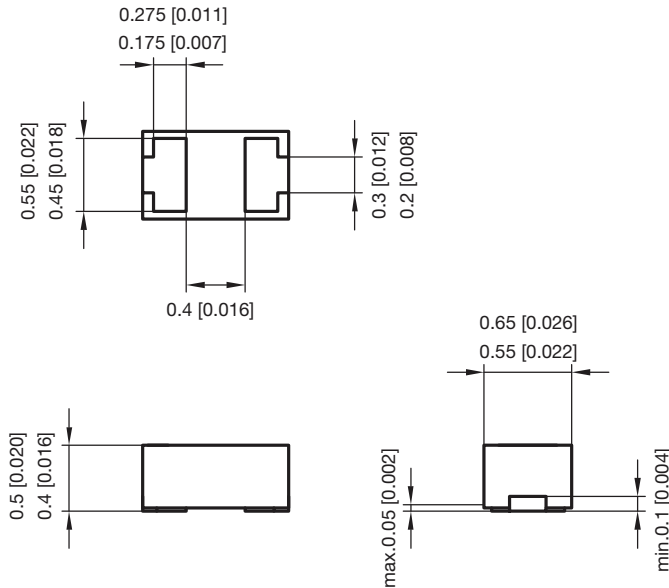

foot print recommendation:

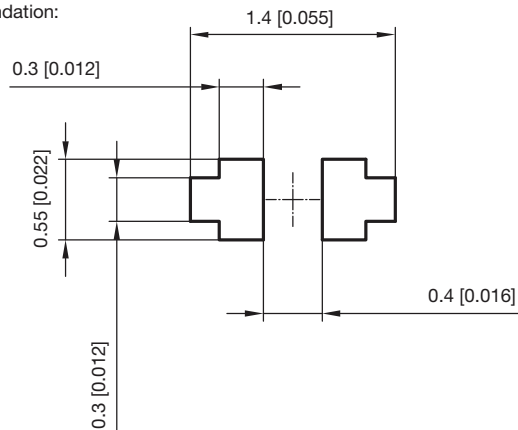

Document no.:S8-V-3906.04-059 (4)

Created - Date: 11.July.2018

Rev.1 - Date: 15.January.2019

[< back](#)



DFN1110-3A PACKAGE DIMENSIONS in millimeters (inches)

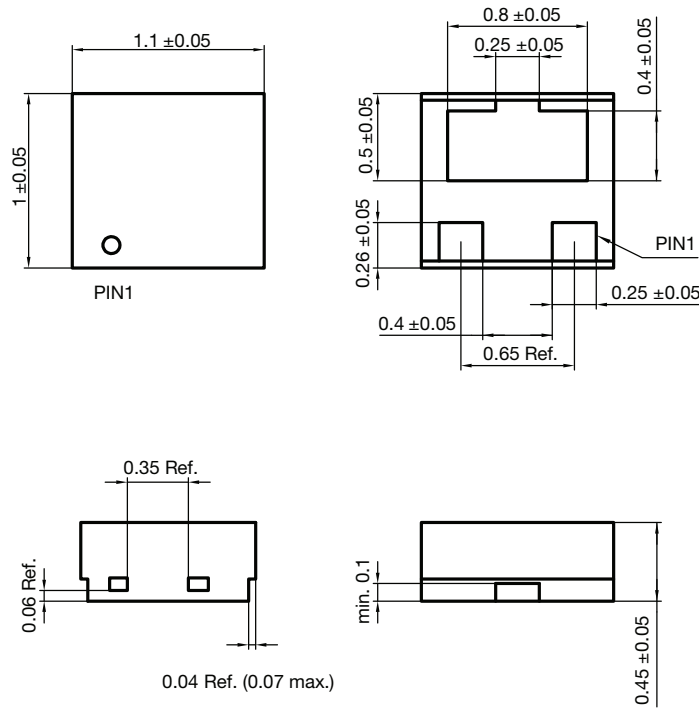

foot print recommendation:

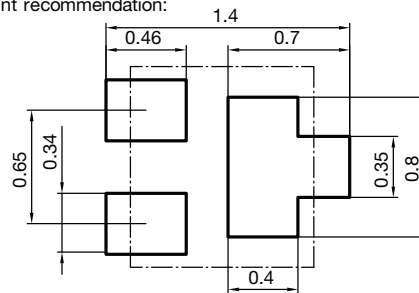

Document no.: S8-V-3906.04-062 (4)

Package name: DFN1110-3A

Created - Date: 04-Apr-2019

[< back](#)



LLP1006-2L PACKAGE DIMENSIONS in millimeters (inches)

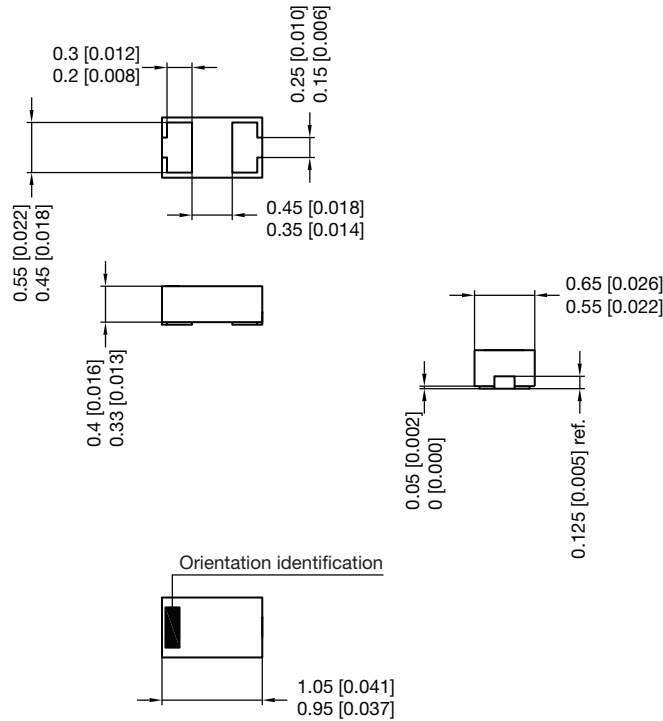

Foot print recommendation:

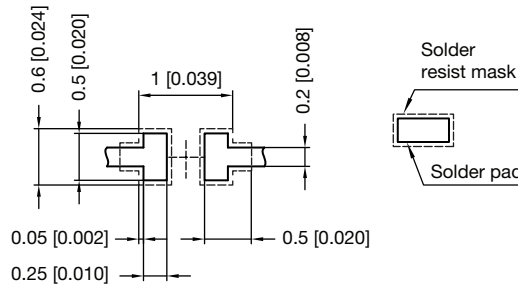

Pad Design Patented:
(©US 9.018.537 B2)

Document no.: S8-V-3906.04-005 (4)
Created - Date: 13.July.2007
Rev. 7 - Date: 11.May 2016
20812

[< back](#)



LLP1006-2M PACKAGE DIMENSIONS in millimeters (inches)

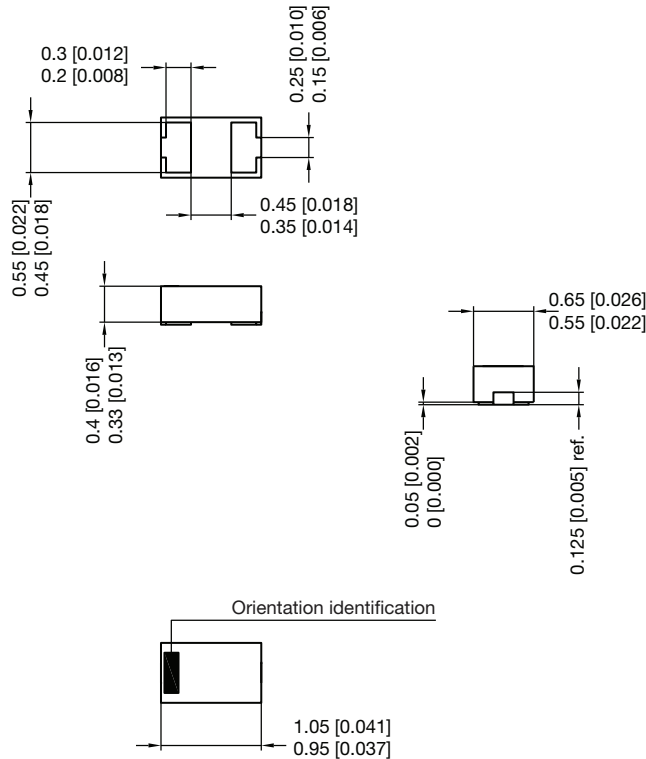

Foot print recommendation:

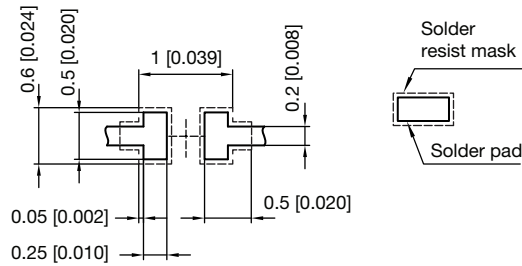

Pad Design Patented:
(© US 9.018.537 B2)

Document no.: S8-V-3906.04-005 (4)
Created - Date: 15.Jun 2009
Rev. 7 - Date: 11.May 2016
20812

[< back](#)



LLP1006-3L PACKAGE DIMENSIONS in millimeters (inches)

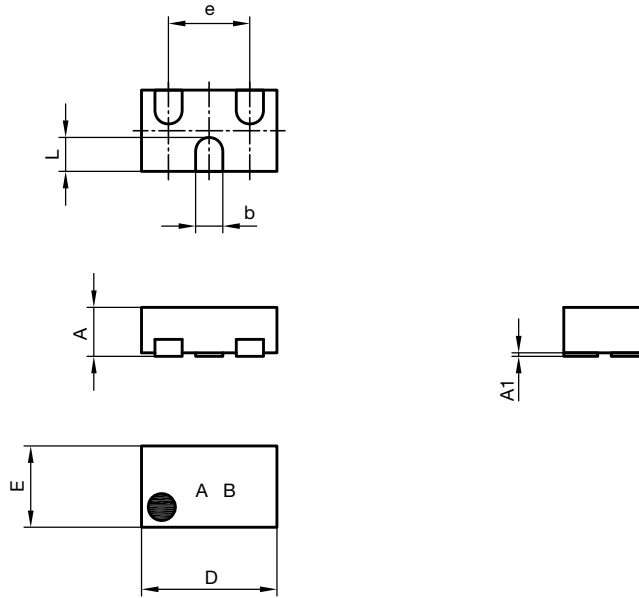

	Millimeters	
	Min.	Max.
D	0.95	1.05
E	0.55	0.65
A	0.33	0.40
A1	0	0.05
b	0.2	
L	0.20	0.30
e	0.6	

Foot print recommendation:

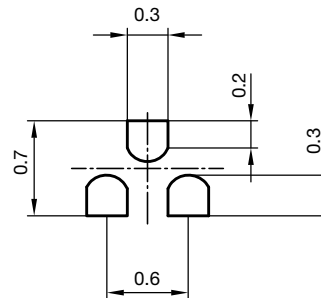

Document no.:S8-V-3906.04-044 (4)
Created - Date: 03. Sep. 2015

[< back](#)



LLP1010-5L PACKAGE DIMENSIONS in millimeters (inches)

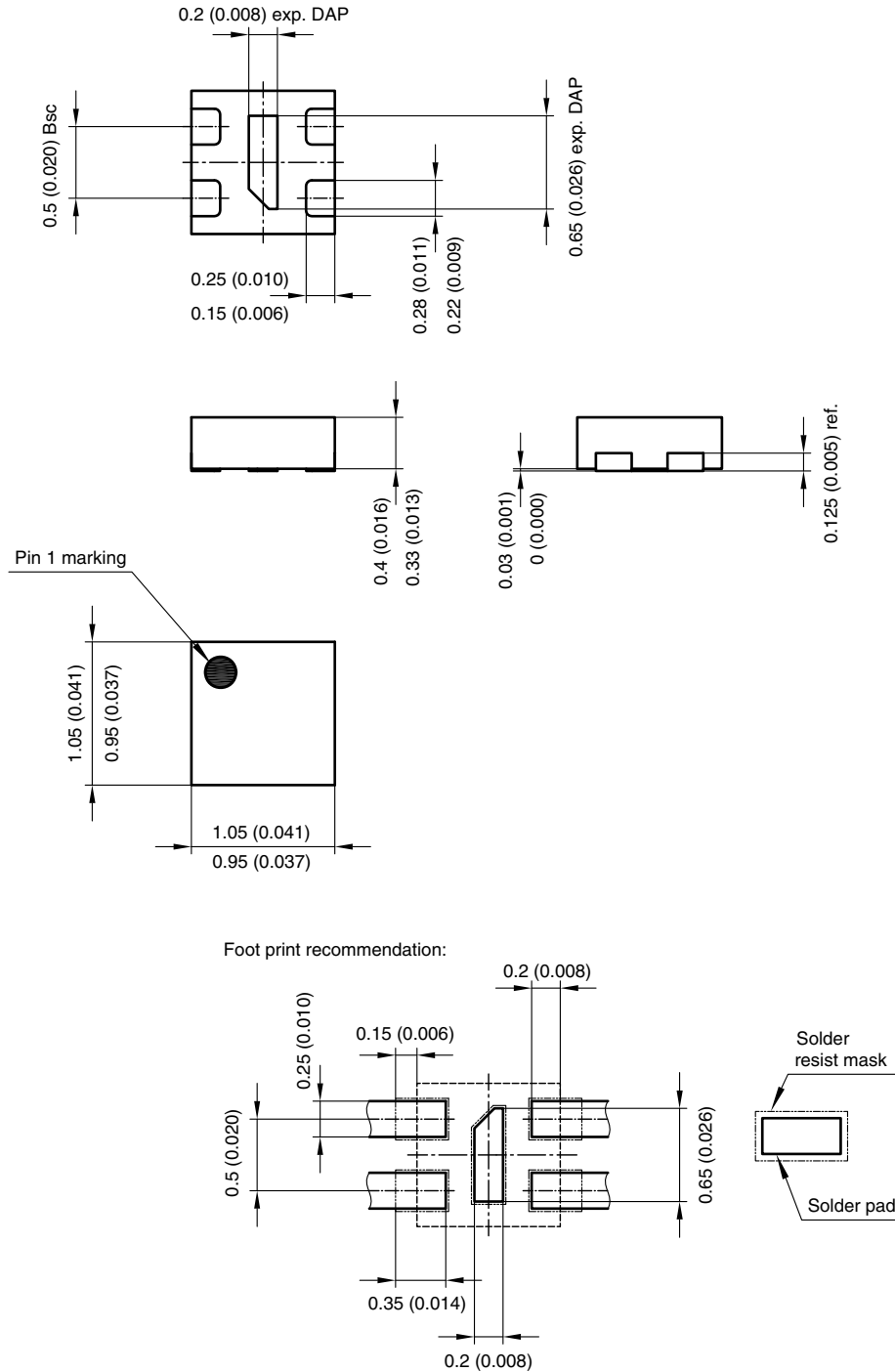

Document no.:S8-V-3906.04-007 (4)
 Created - Date: 15. April. 2008
 Rev. 3 - Date: 11. May. 2016

[< back](#)



LLP1010-6M PACKAGE DIMENSIONS in millimeters

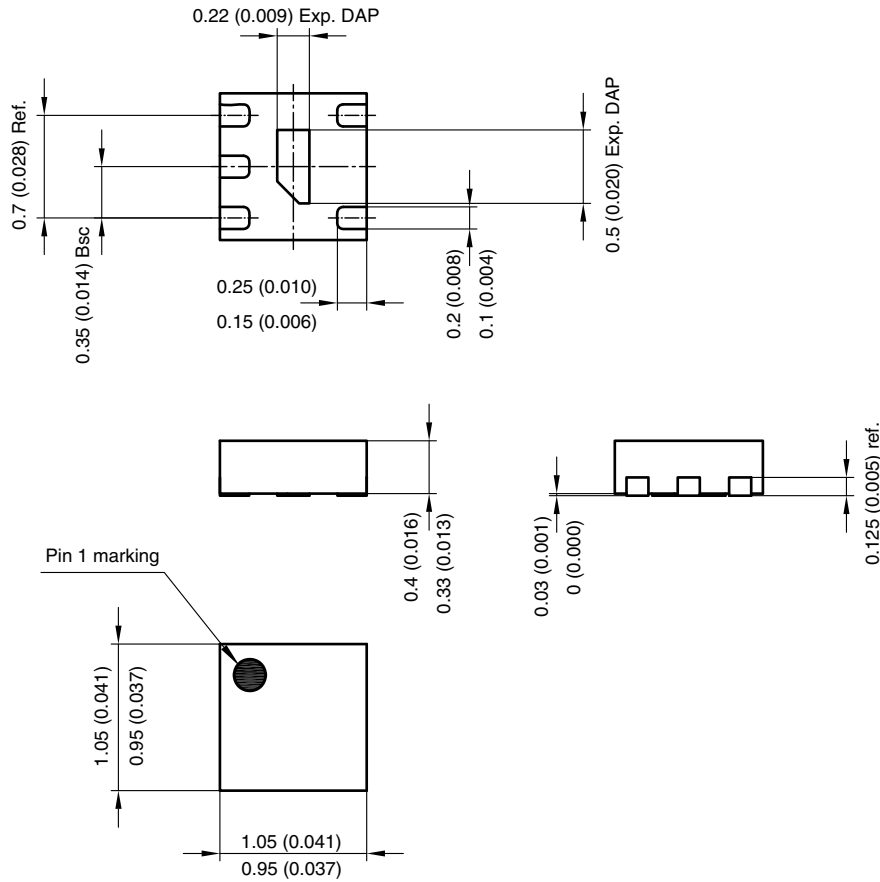

Foot print recommendation:

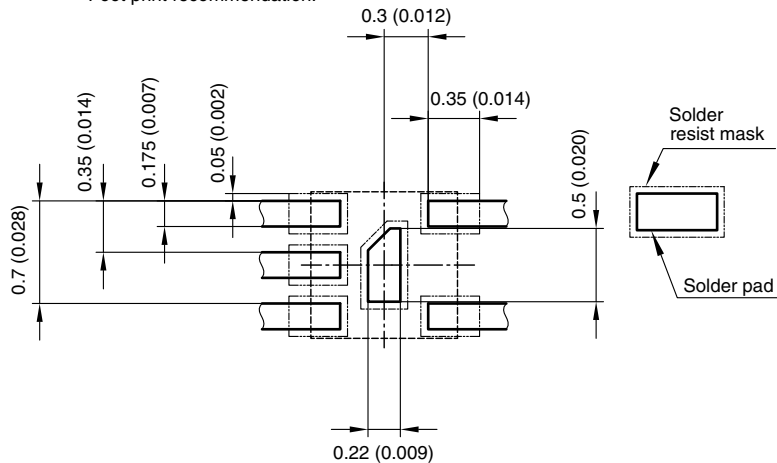

Document no.:S8-V-3906.04-004 (4)

Created - Date: 17.July 2007

Rev. 5 - Date: 11.May 2016

[< back](#)

LLP1713-7L PACKAGE DIMENSIONS in millimeters (inches)

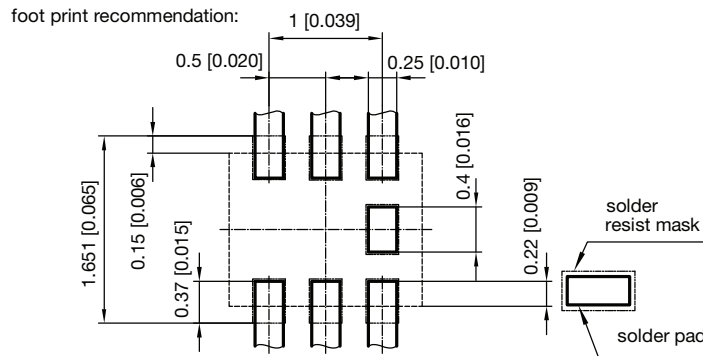
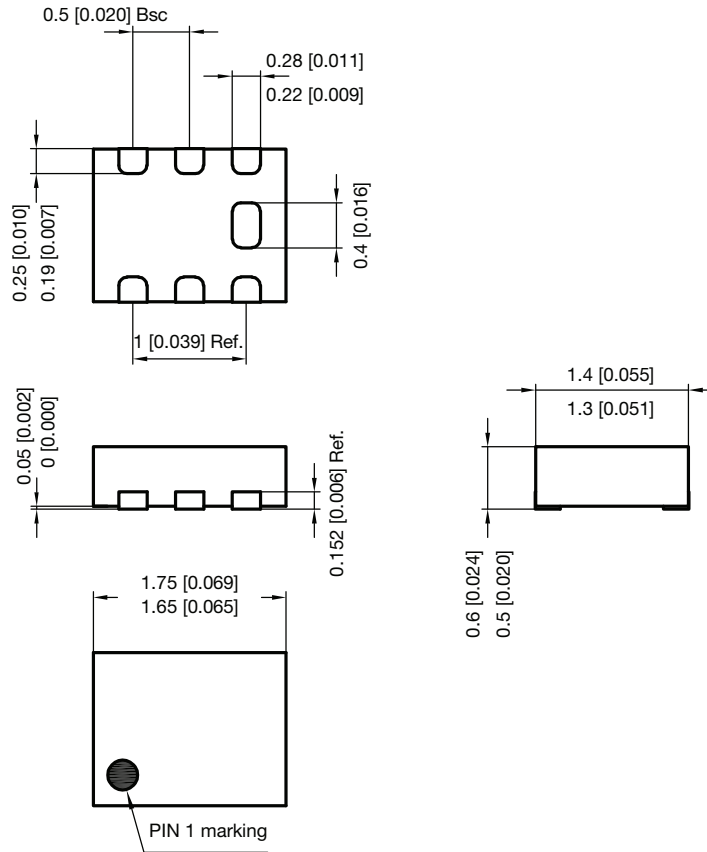

Document no.:S8-V-3906.04-008 (4)
 Created - Date: 15. April 2008
 Rev. 3 - Date: 10.Okt.2019

[< back](#)

LLP1713-9L PACKAGE DIMENSIONS in millimeters (inches)

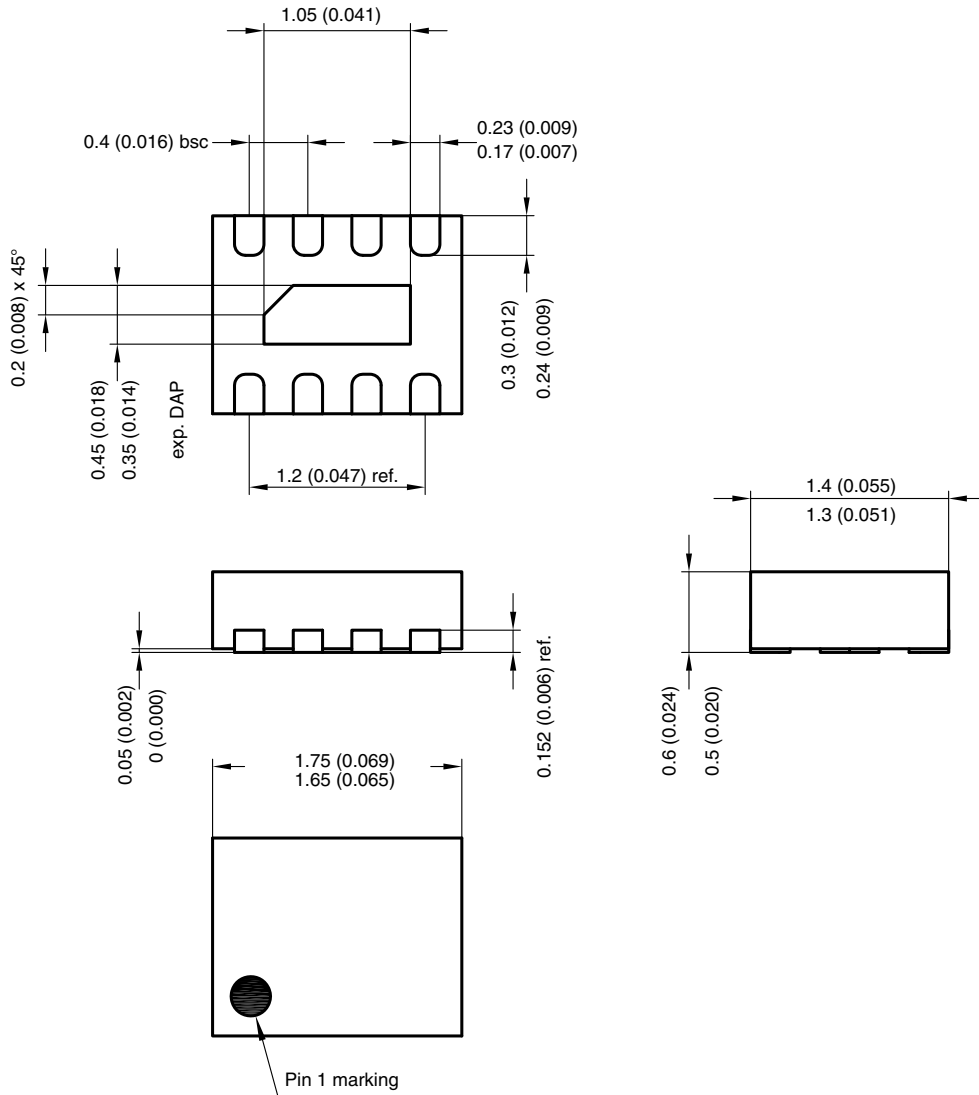

Foot print recommendation:

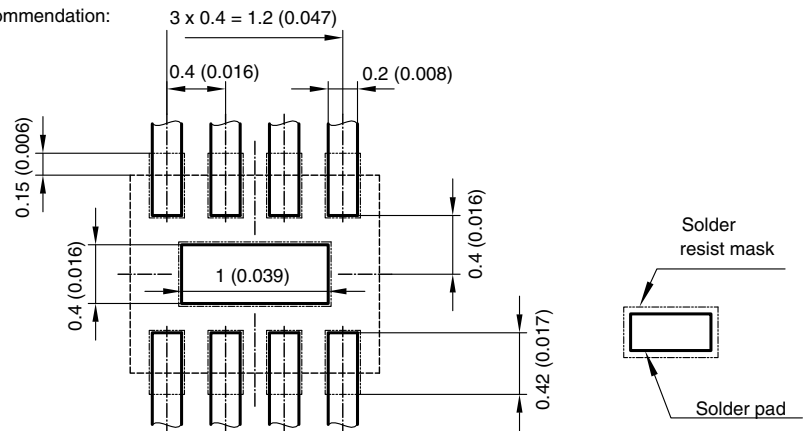

Document no.:S8-V-3906.04-001 (4)
 Created - Date: 28. August 2006
 Rev. 1 - Date: 27. May 2008

[< back](#)



LLP2513-13L PACKAGE DIMENSIONS in millimeters (inches)

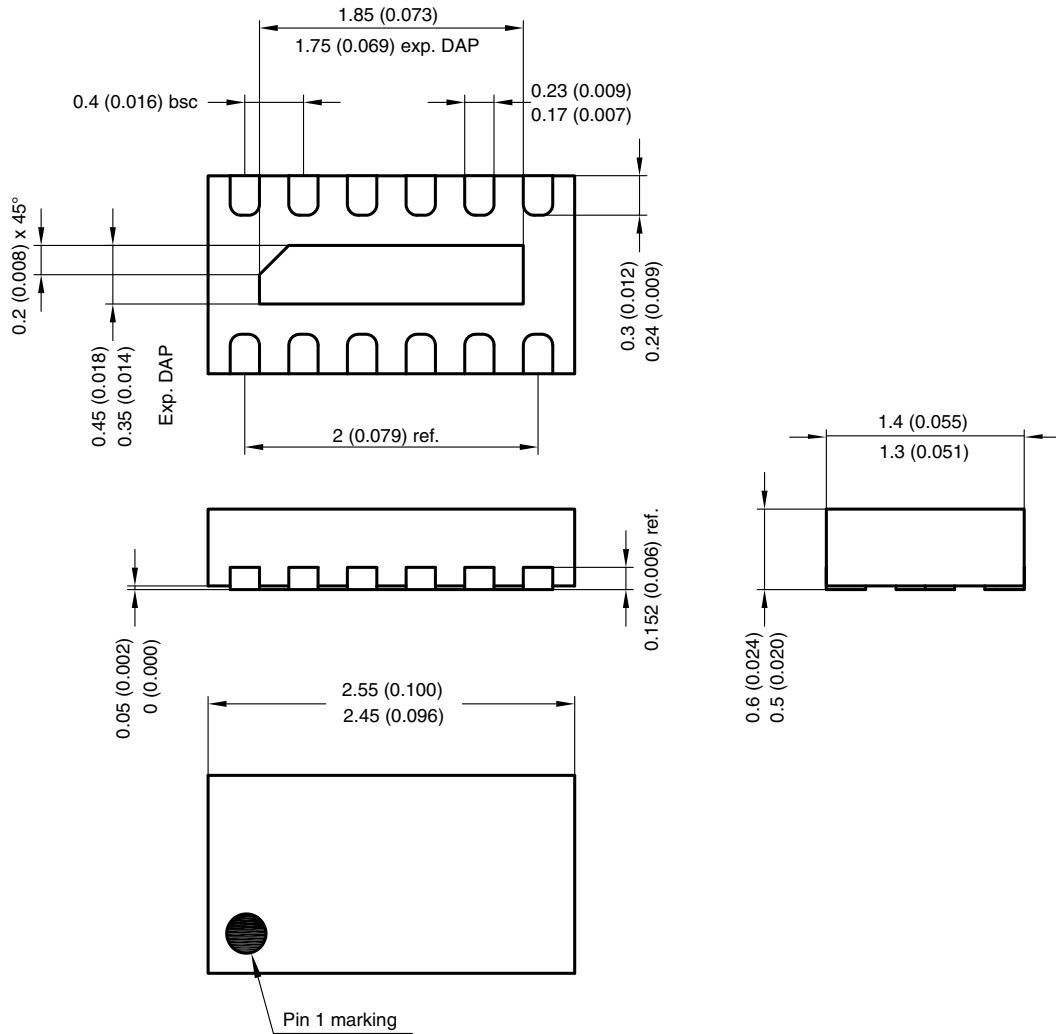

Foot print recommendation:

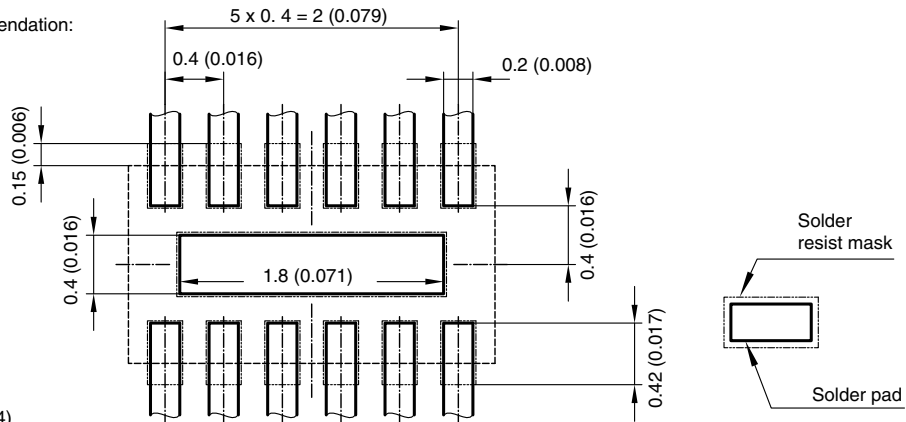

Document no.:S8-V-3906.04-002 (4)
Created - Date: 28. August 2006
Rev. 1 - Date: 27. May 2008

[< back](#)

LLP3313-17L PACKAGE DIMENSIONS in millimeters (inches)

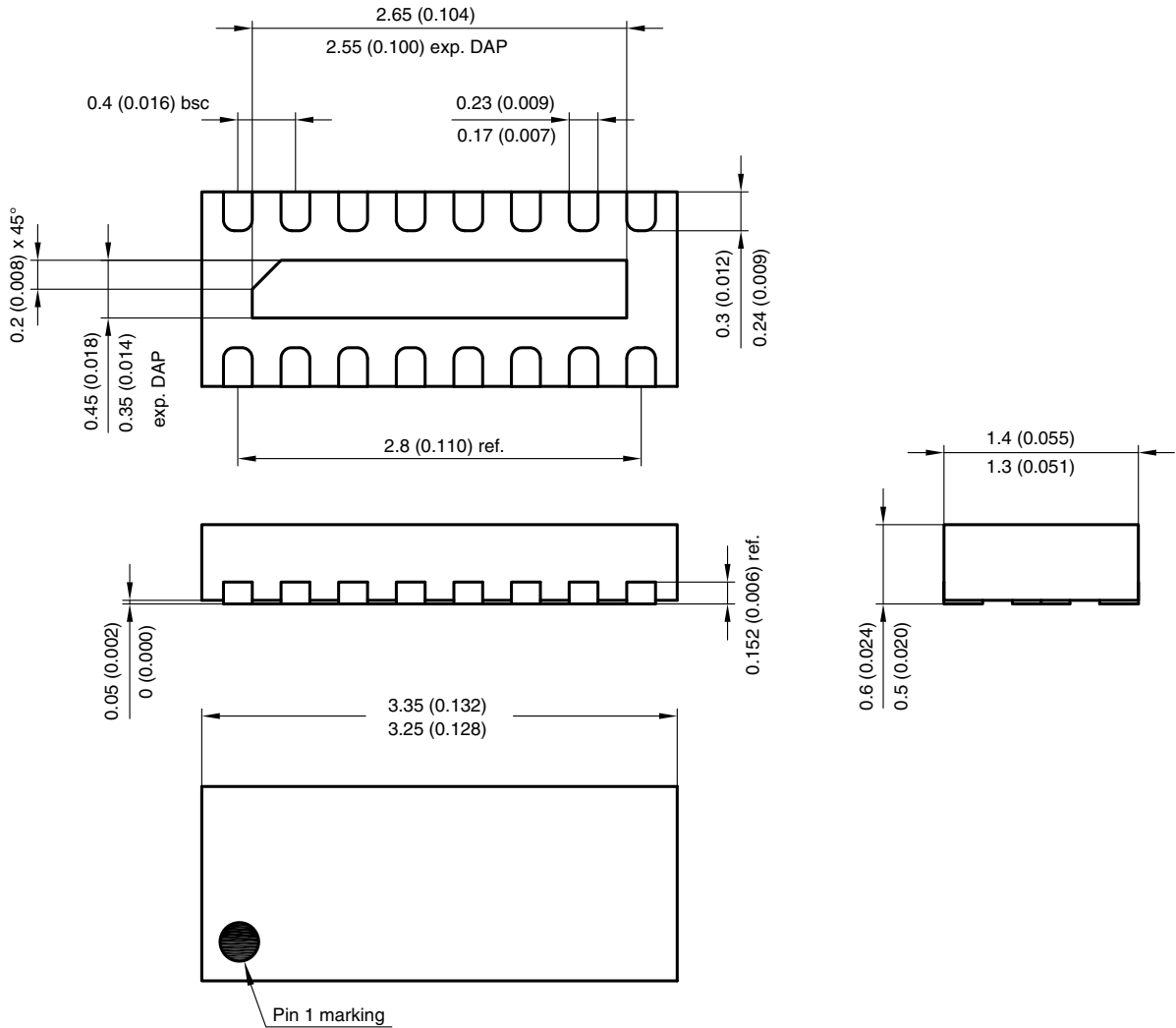

Foot print recommendation:

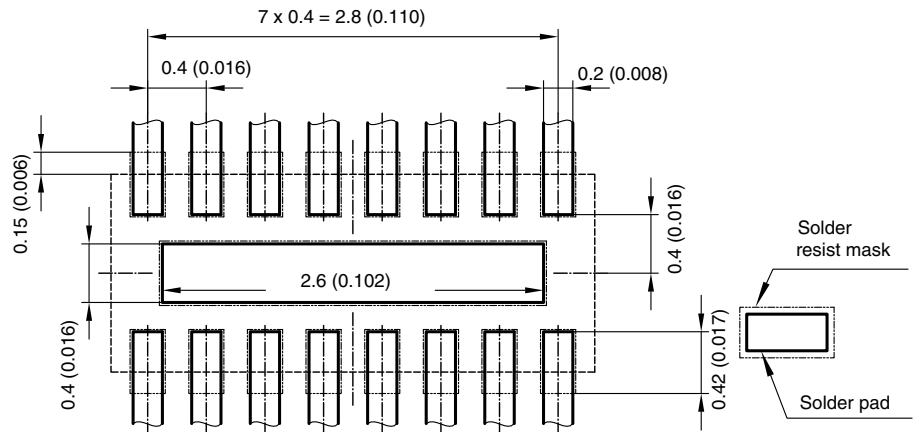

Document no.:S8-V-3906.04-003 (4)
 Created - Date: 28. August 2006
 Rev. 1 - Date: 27. May 2008

[< back](#)

LLP75-4L PACKAGE DIMENSIONS in millimeters (inches)

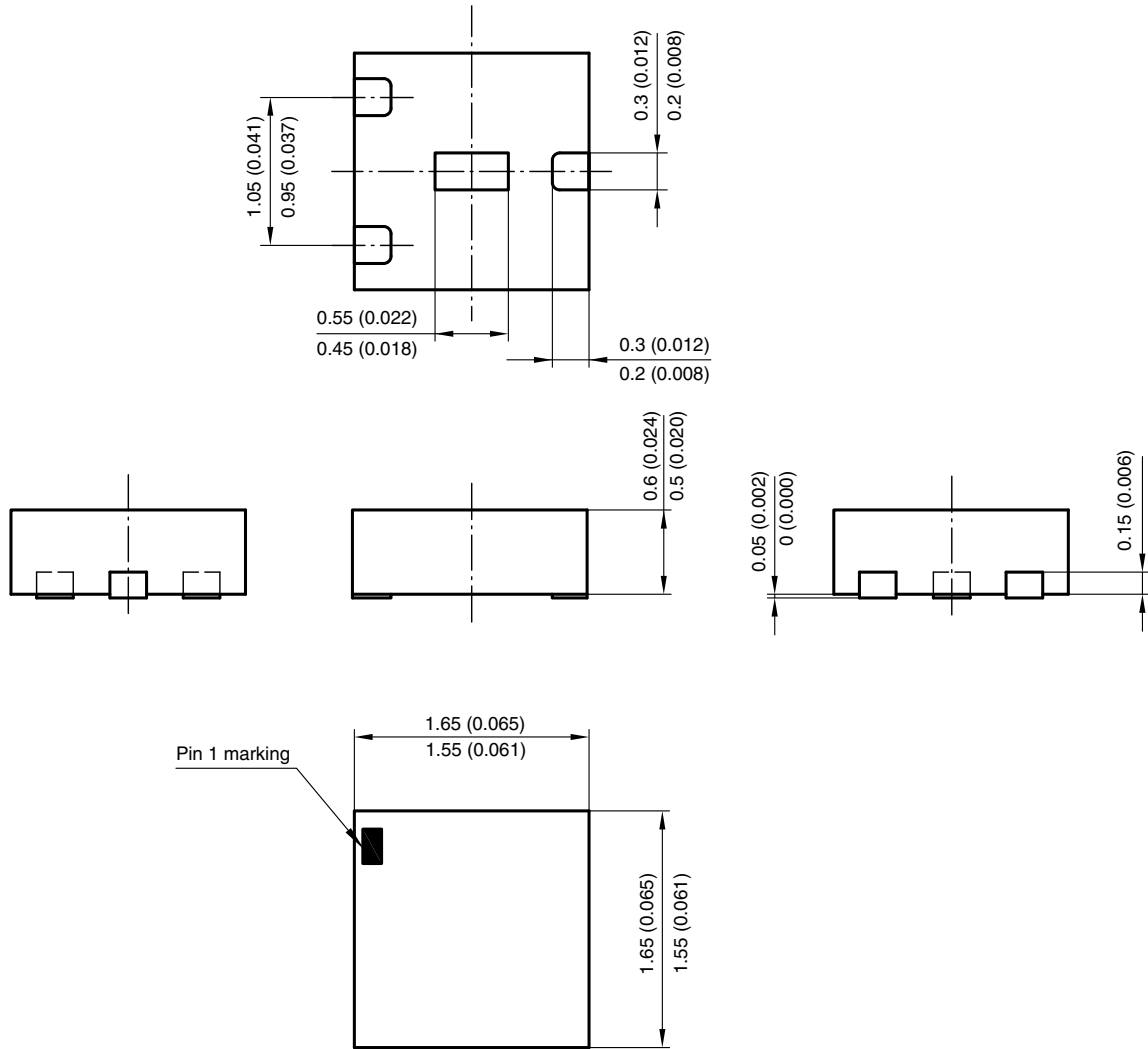

Foot print recommendation:

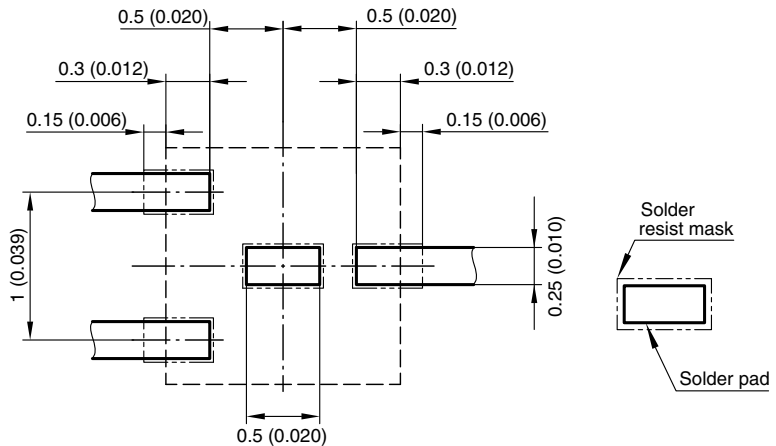

Document no.:S8-V-3906.02-015 (4)
 Created - Date: 04. September 2007
 Rev. 2 - Date: 09. Sep. 2008

[< back](#)



LLP75-6L PACKAGE DIMENSIONS in millimeters (inches)

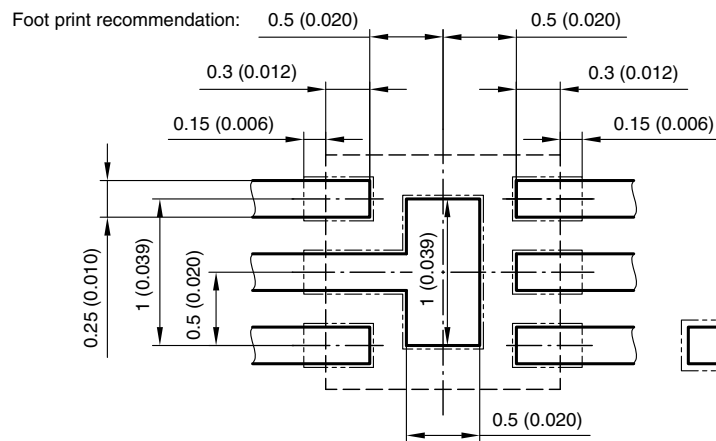
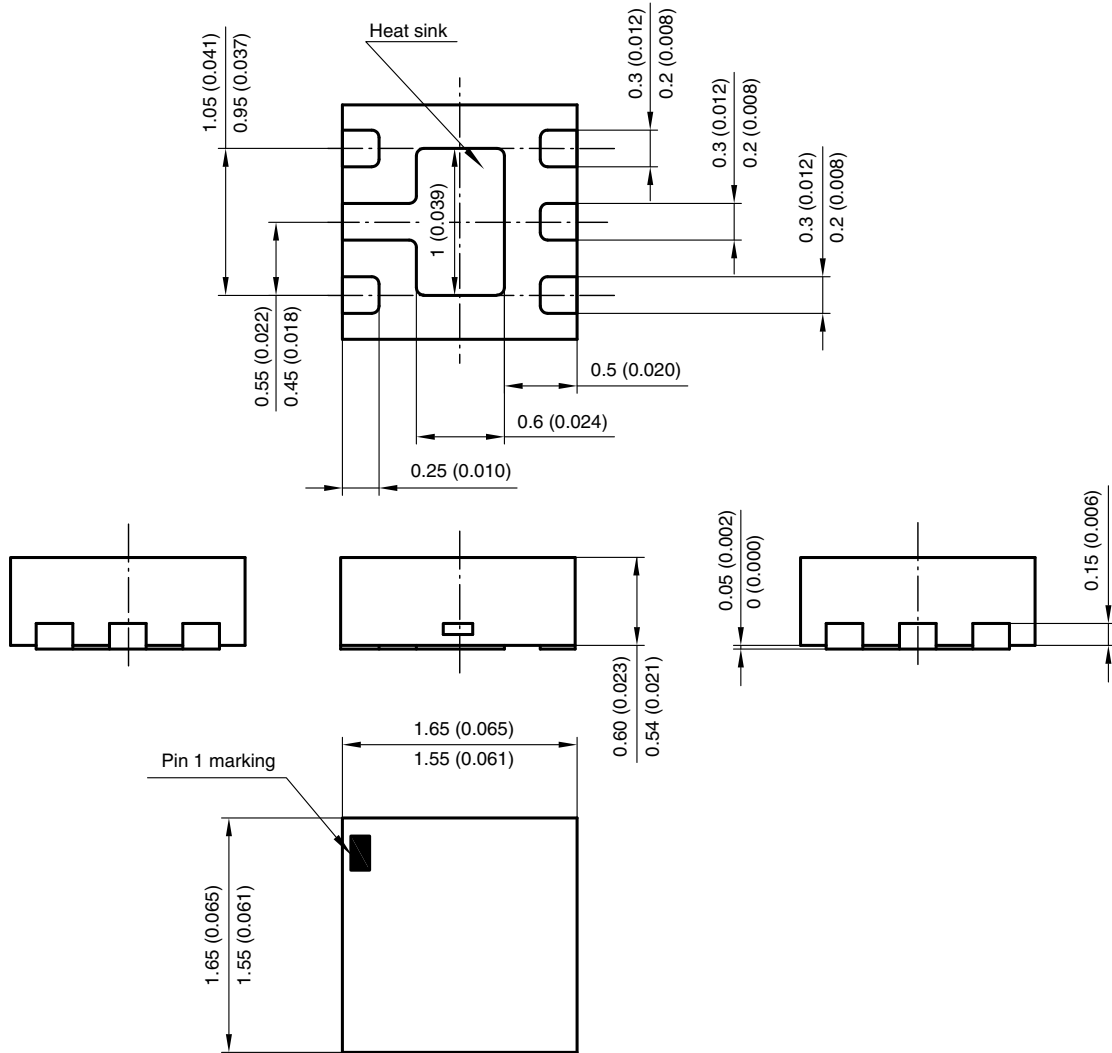

Document no.:S8-V-3906.02-010 (4)
 Created - Date: 04. May 2005
 Rev. 4 - Date: 21. March 2006

[< back](#)



LLP75-7L PACKAGE DIMENSIONS in millimeters (inches)

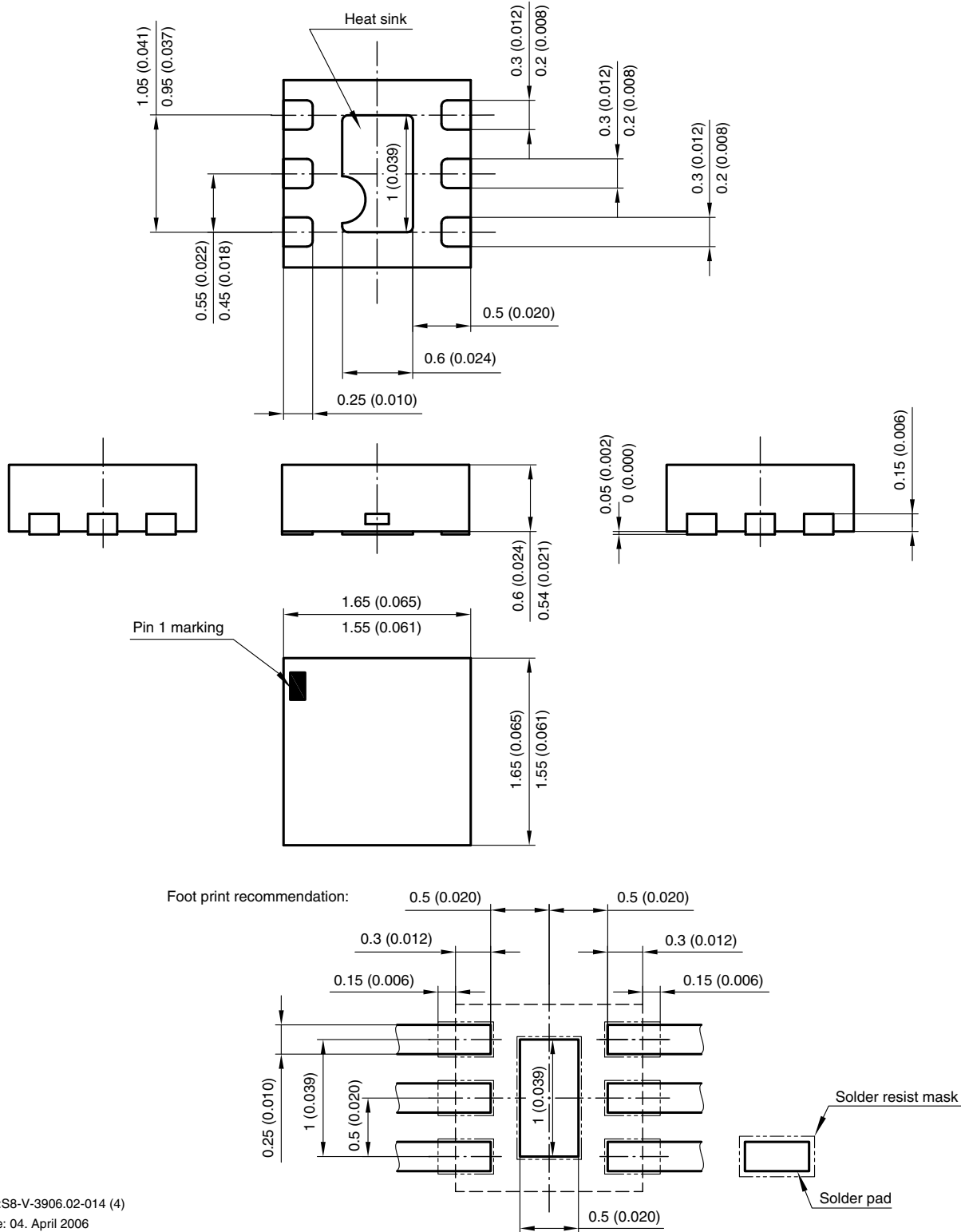

Document no.:S8-V-3906.02-014 (4)
Created - Date: 04. April 2006

[< back](#)



SOD-123 PACKAGE DIMENSIONS in millimeters (inches)

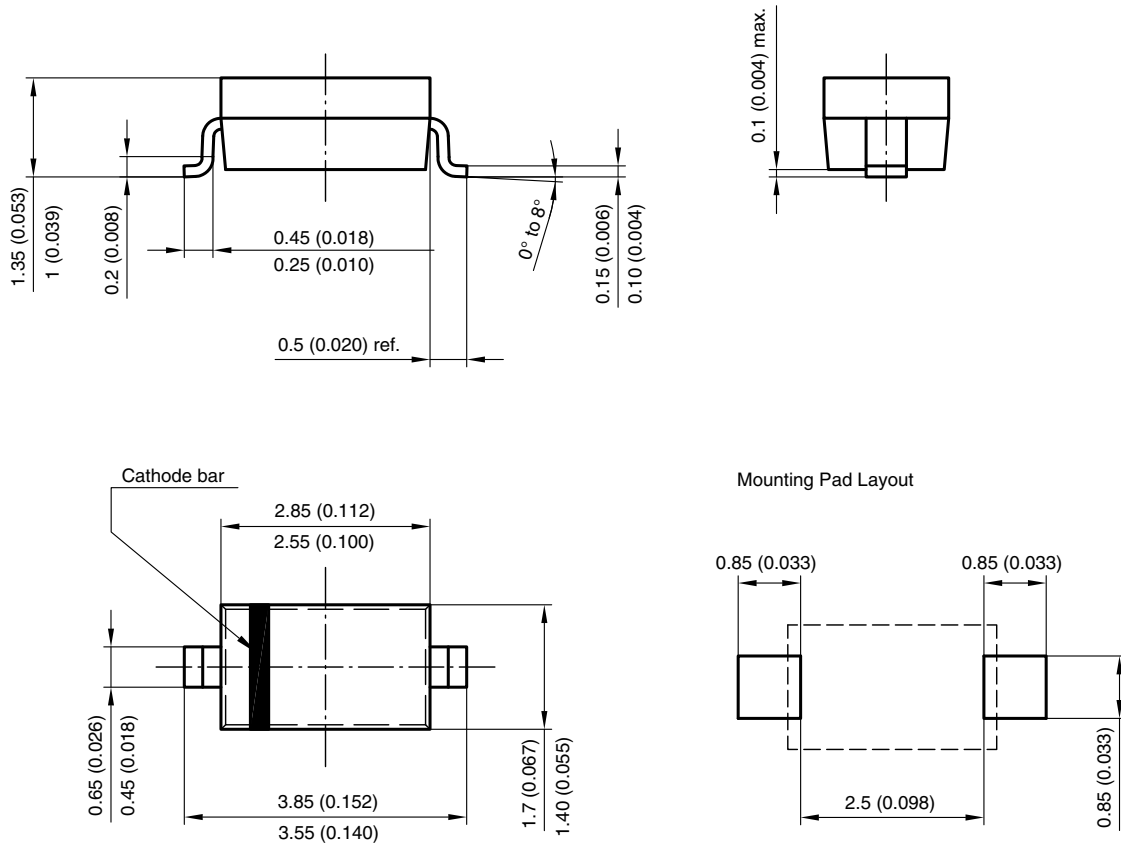

Rev. 4 - Date: 24. Sep. 2009
Document no.: S8-V-3910.01-001 (4)

[< back](#)



SOD-323 PACKAGE DIMENSIONS in millimeters (inches)

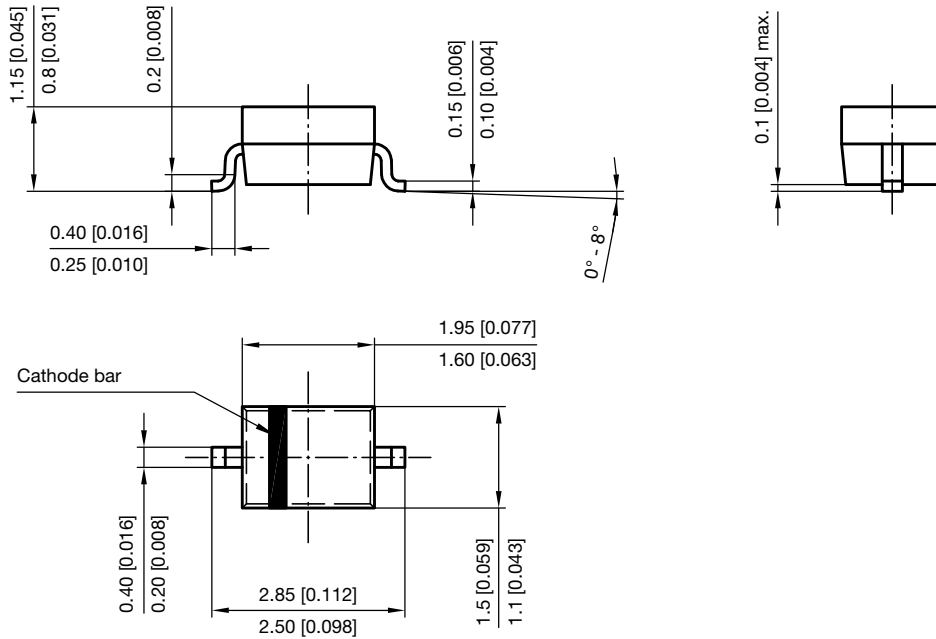

Footprint recommendation:

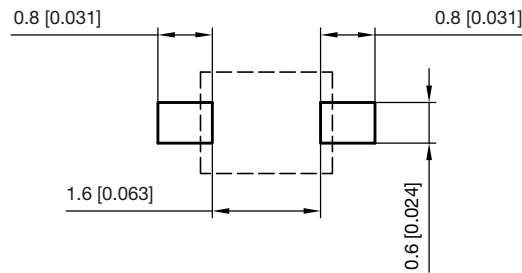

Document no.: S8-V-3910.02-001 (4)
Created - Date: 24.August.2004
Rev. 6 - Date: 23.Sept.2016

[< back](#)



SOD-523 PACKAGE DIMENSIONS in millimeters (inches)

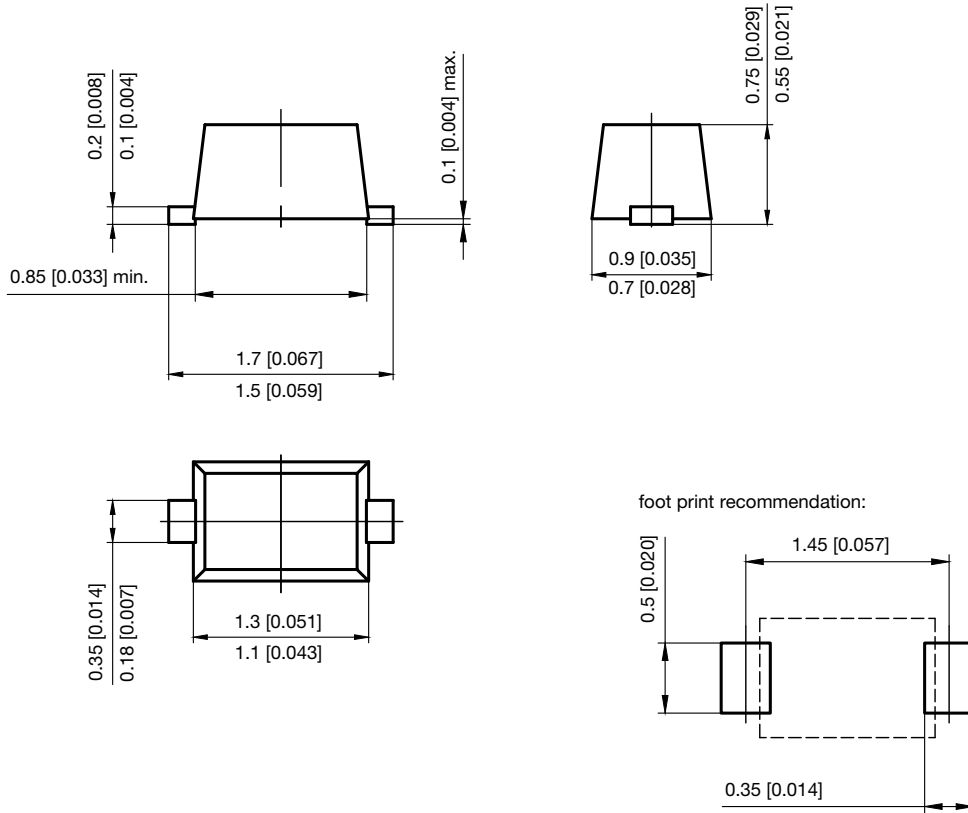

Document no.: S8-V-3880.02-003 (4)
Create Date: 04-Apr-2017
Rev. 3 Date: 27-May-2019

[< back](#)



SOT-23 PACKAGE DIMENSIONS in millimeters (inches)

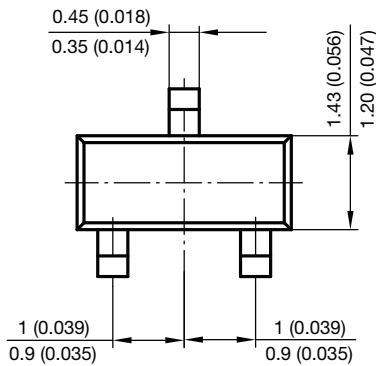
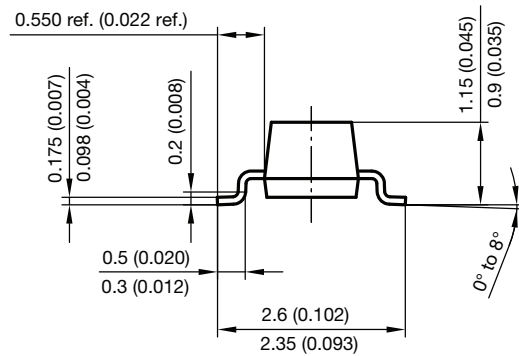
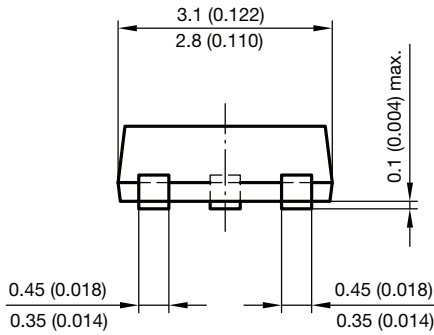

Foot print recommendation:

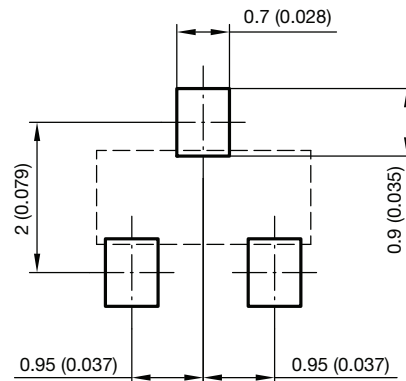



SOT-323 PACKAGE DIMENSIONS in millimeters (inches)

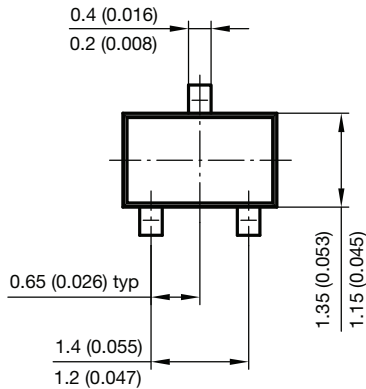
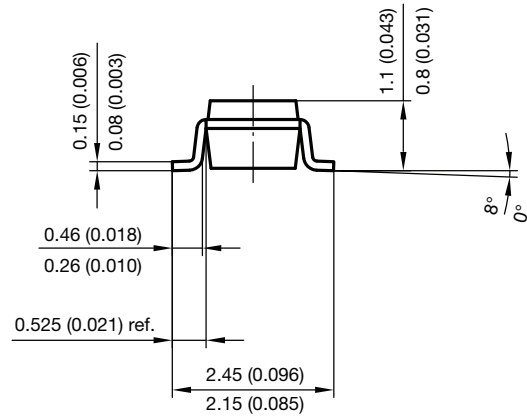
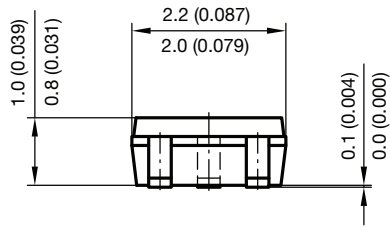

foot print recommendation:

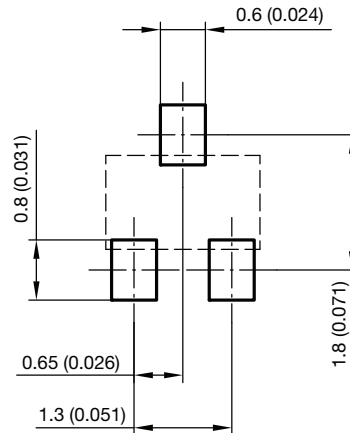

Document no.: 6.541-5040.02-4
Rev. 1 - Date: 06. April 2010

[< back](#)



SOT-363 PACKAGE DIMENSIONS in millimeters (inches)

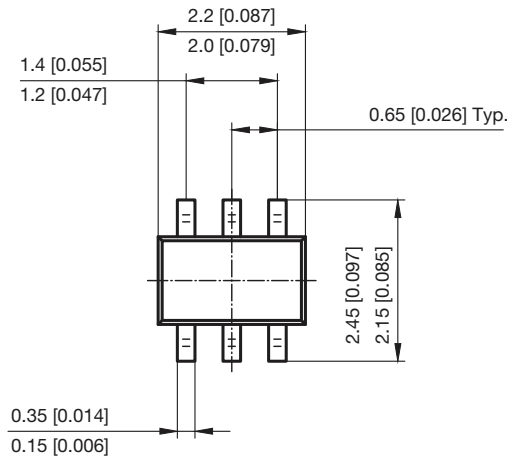
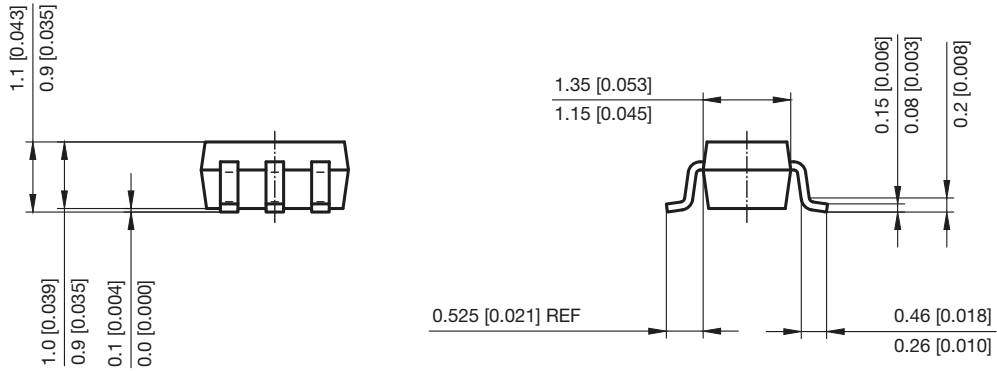

foot print recommendation:

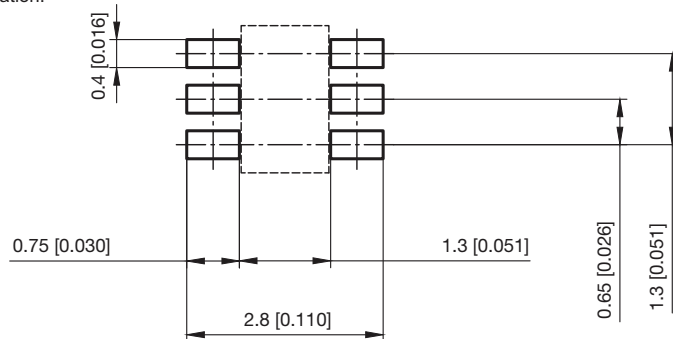

Document no.: S8-V-3855.02-002 (4)

Created - Date: 23.June.2017

[< back](#)



SMF (DO-219AB) PACKAGE DIMENSIONS in millimeters (inches)

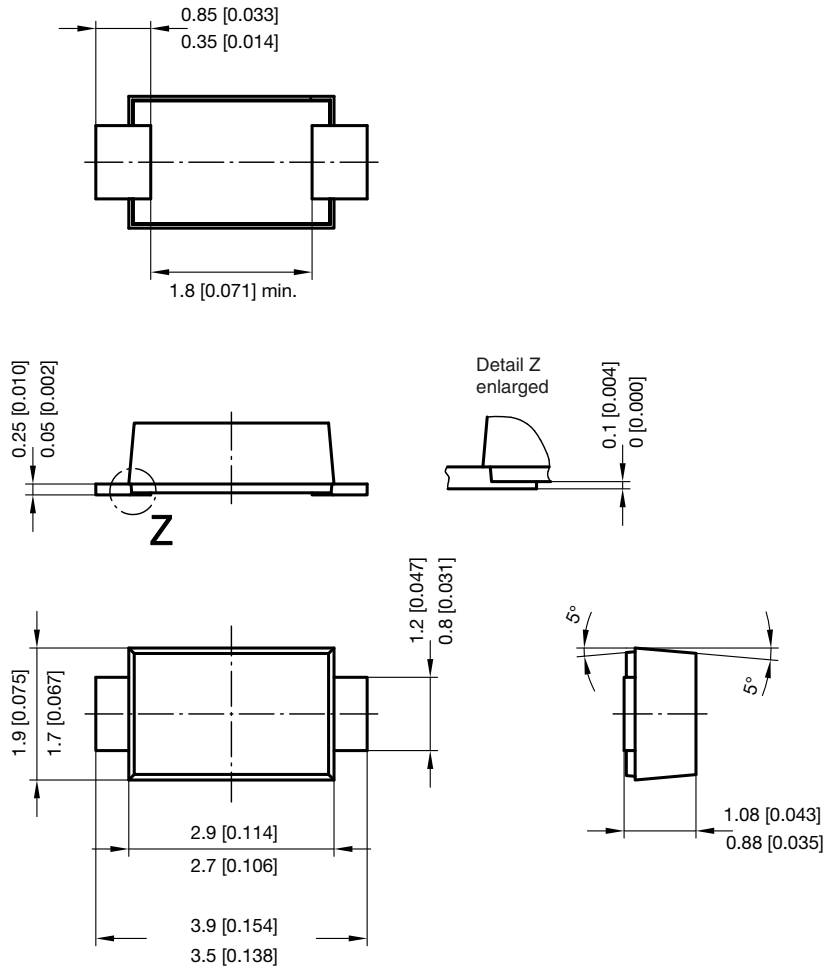

foot print recommendation:

Reflow soldering

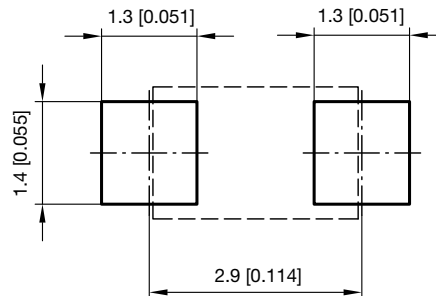

Document no.: S8-V-3915.01-001 (4)

Created - Date: 15. February 2005

Rev. 5 - Date: 09. Oct. 2017

[< back](#)



SMA (DO-214AC) PACKAGE DIMENSIONS in millimeters (inches)

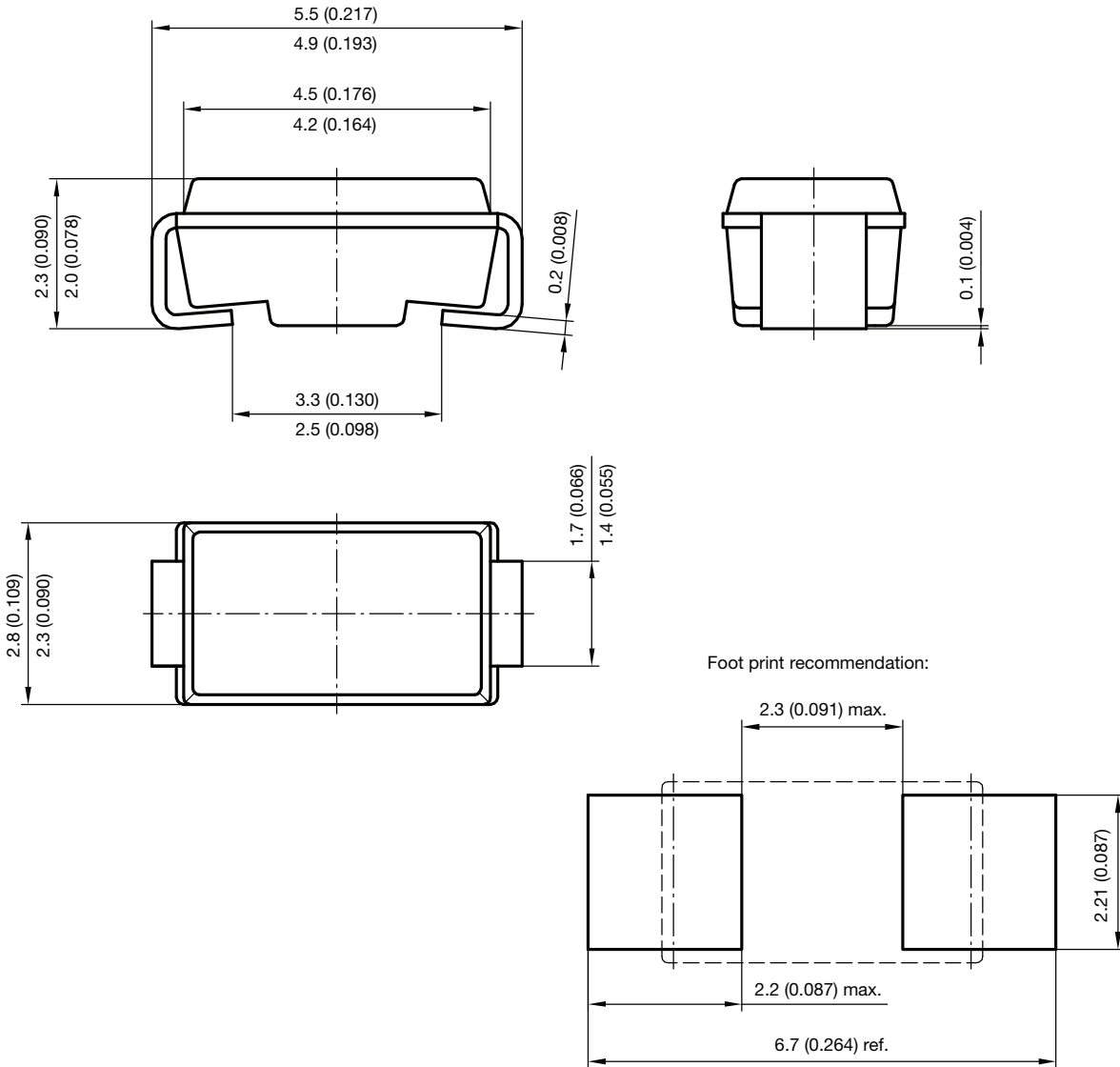

Document no.: S8-V-3848.01-003 (4)
 Created - Date: 18. February 1997
 Rev. 8 - Date: 10. November 2006

[< back](#)



MELF DO-213AB (PLASTIC) PACKAGE DIMENSIONS in millimeters (inches)

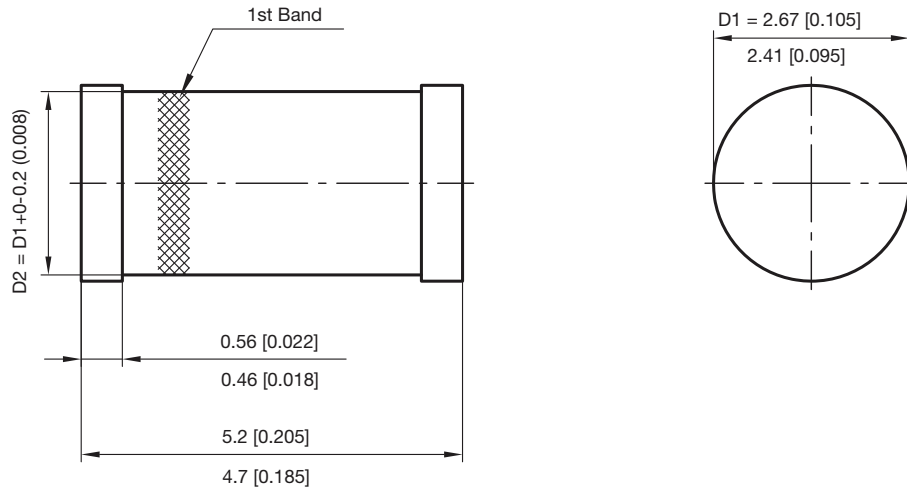

1st Band denotes type and positive end (cathode)

foot print recommendation:

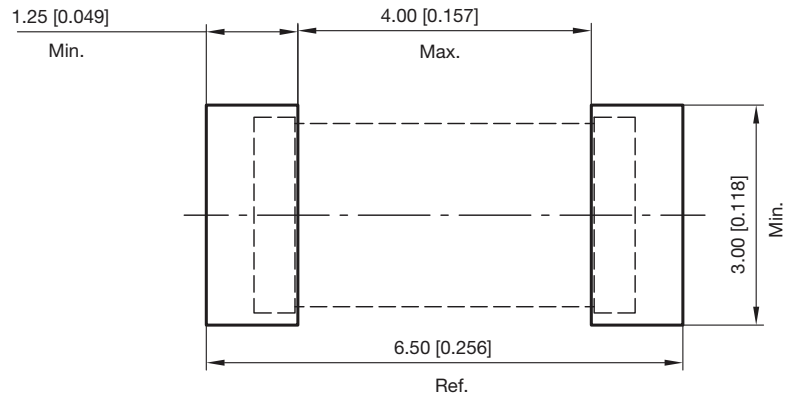

Document no.:S8-V-3453.03-001 (4)
Created - Date: 13.May.2009

[< back](#)



MELF DO-213AB (GLASS) PACKAGE DIMENSIONS in millimeters (inches)

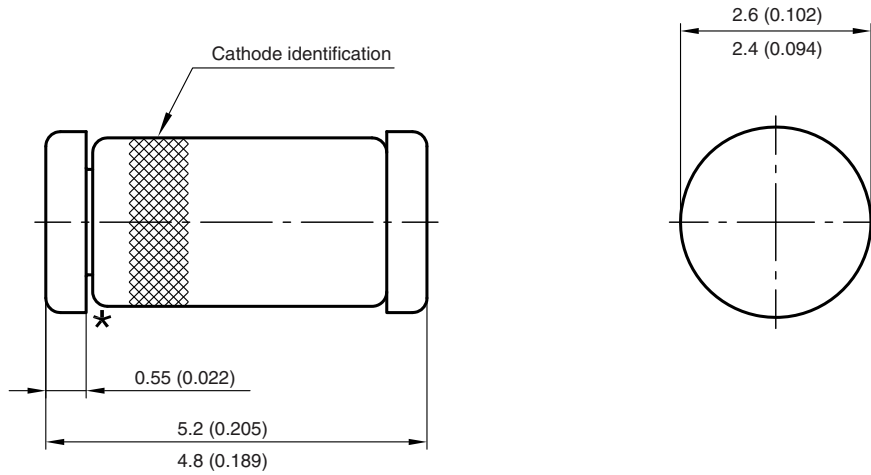

★ The gap between plug and glass can be either on cathode or anode side

Foot print recommendation:

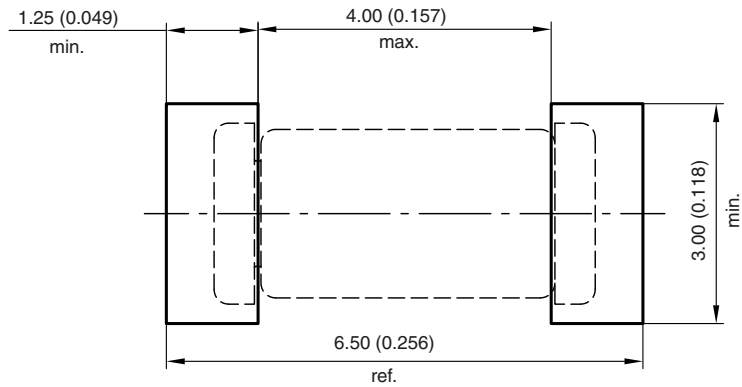

Document no.:S8-V-3453.02-001 (4)
Rev. 3 - Date: 07 June 2006

[< back](#)



MicroMELF PACKAGE DIMENSIONS in millimeters (inches)

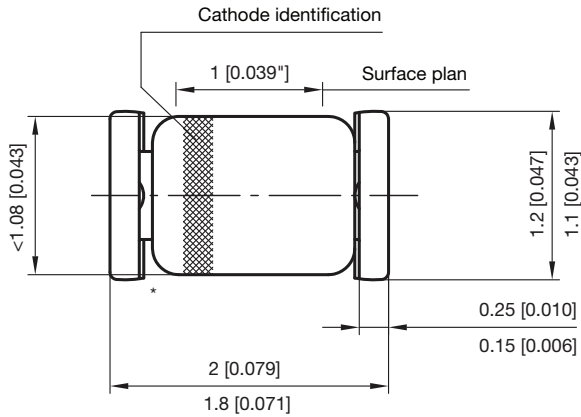

* The gap between plug and glass can be either on cathode or anode side

foot print recommendation:

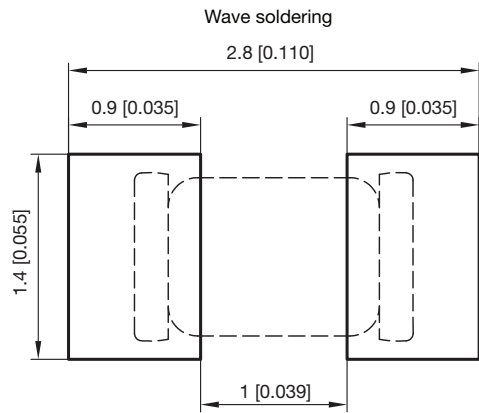
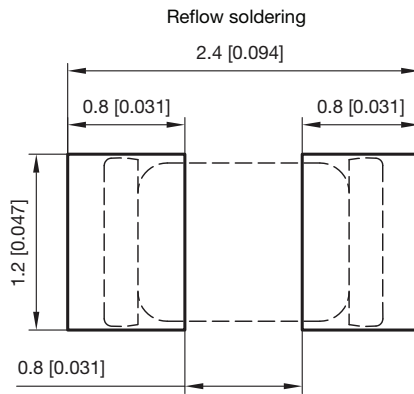

Document no.:6.560-5007.02-4
Created - Date: 23.February.2004
Rev. 02 - Date: 27.February.2007

[< back](#)

MicroSMF (DO-219AC) PACKAGE DIMENSIONS in millimeters

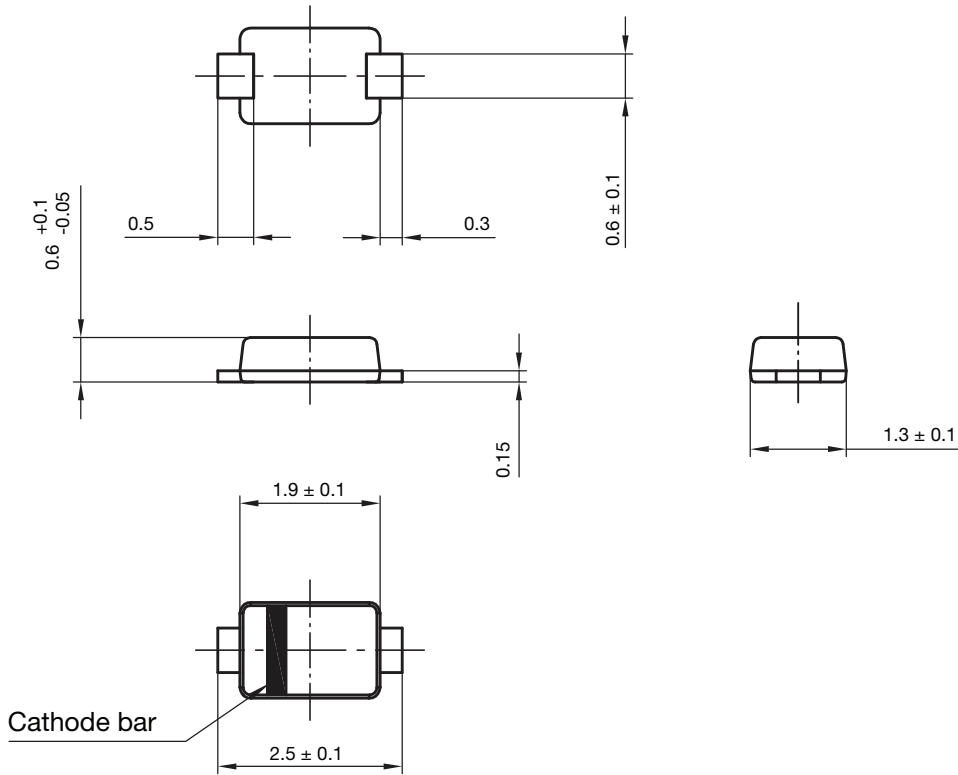

foot print recommendation
for wave soldering:

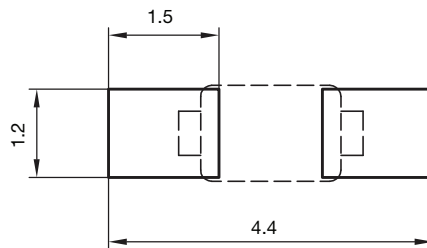

foot print recommendation
for reflow soldering:

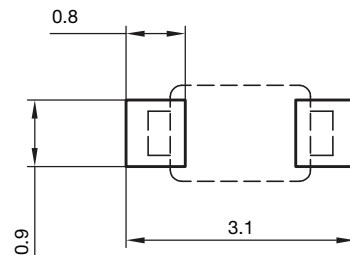

Document no.:S8-V-3910.03-001 (4)
Created - Date: 02.Dec.2010
Rev. 5 - Date: 06.May. 2014

[< back](#)



MiniMELF (SOD-80) PACKAGE DIMENSIONS in millimeters (inches)

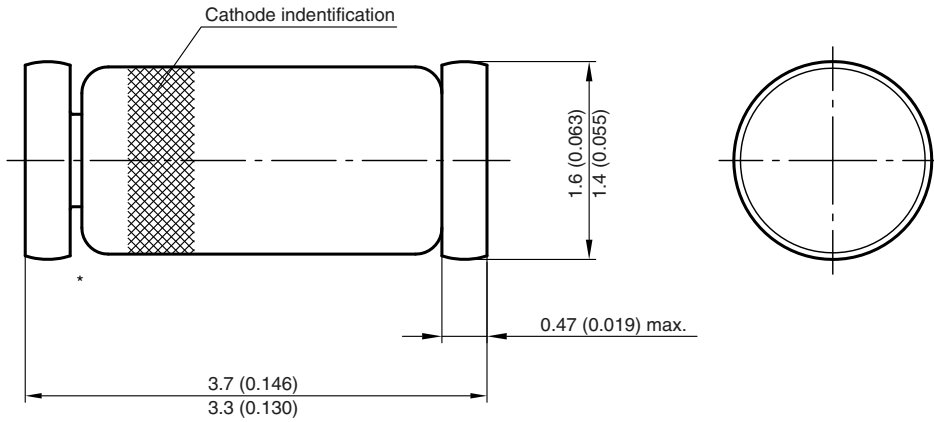

* The gap between plug and glass can be either on cathode or anode side

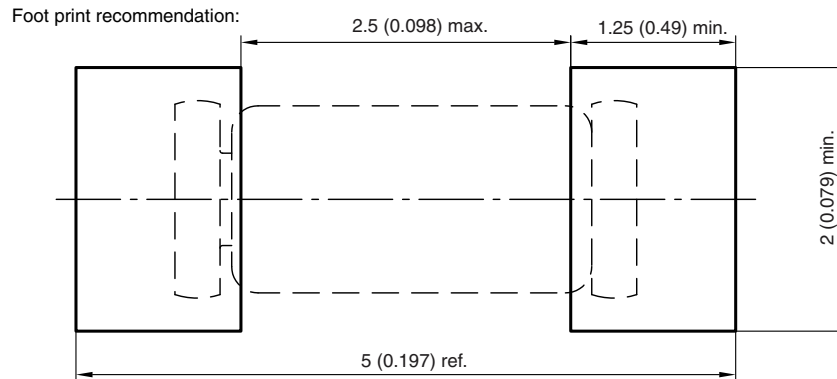

Document no.:6.560-5005.01-4
Rev. 8 - Date: 07.June.2006

[< back](#)



QuadroMELF (SOD-80) PACKAGE DIMENSIONS in millimeters (inches)

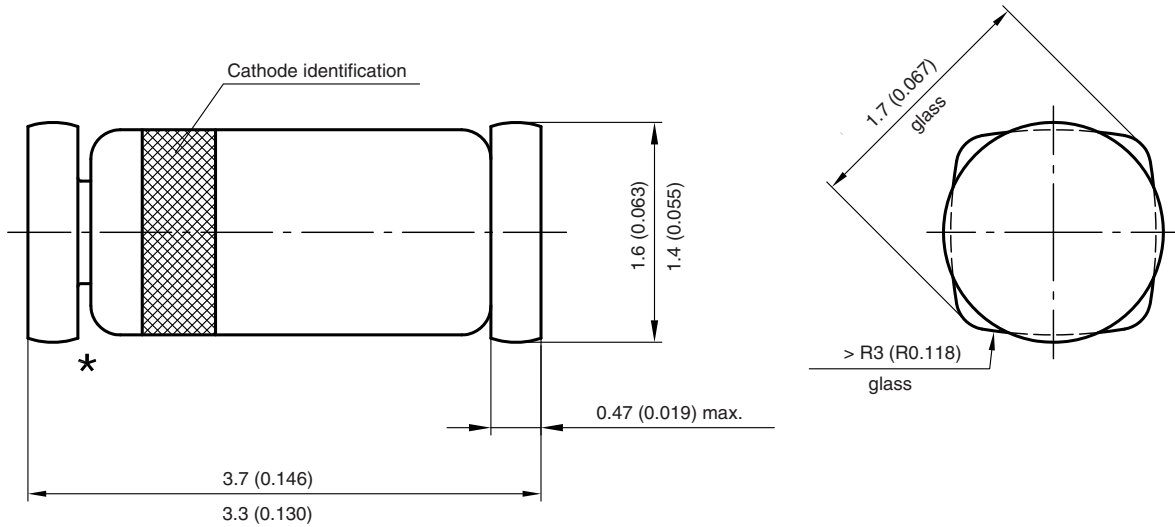

* The gap between plug and glass can be either on cathode or anode side

Foot print recommendation:

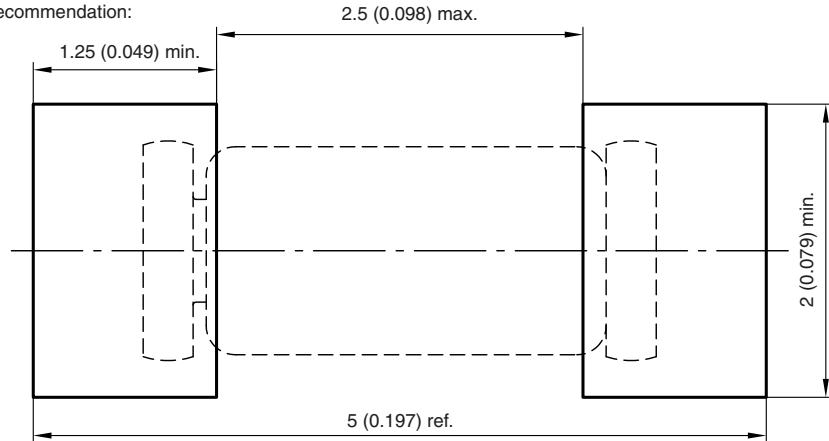

Created - Date: 03.November.2003
 Rev. 11 - Date: 07.June 2006
 Document no.:6.560-5006.01-4

[< back](#)



DO-35 (DO-204AH) PACKAGE DIMENSIONS in millimeters (inches)

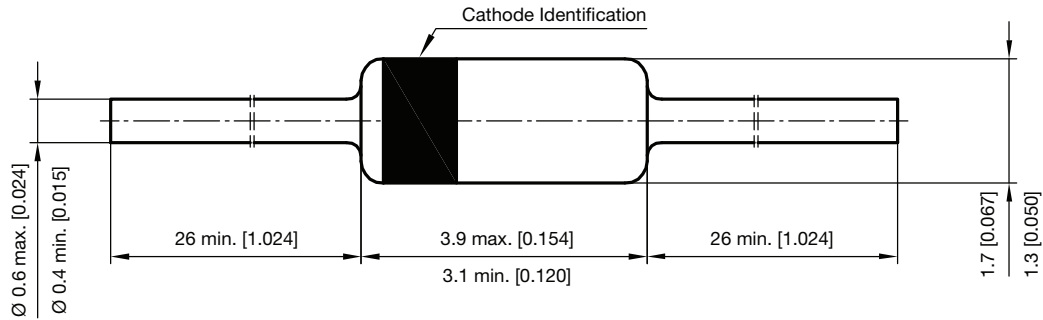

Document no.: SB-V-3906.04-031(4)
Rev. 6 - Date: 19. December 2011

[< back](#)

DO-35_02 PACKAGE DIMENSIONS in millimeters (inches)

only for 1N4148 from Tak Cheong (non-automotive part)

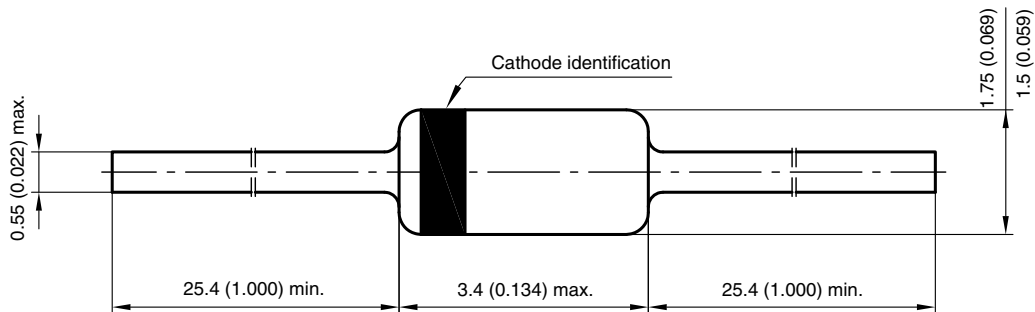

Document no.: 6.560-5004.12-4
Created - Date: 17. March 2008

[< back](#)

DO-41 (DO-204AL) (GLASS) PACKAGE DIMENSIONS in millimeters (inches)

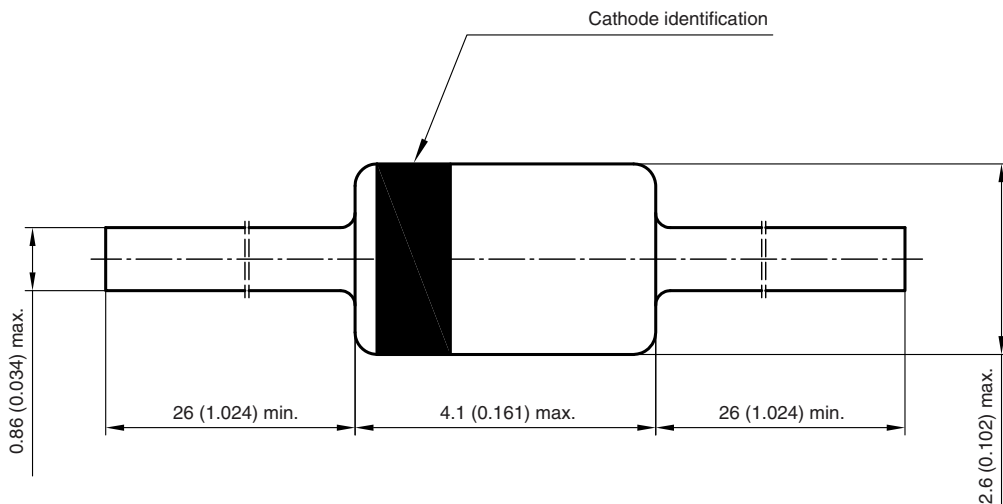

Document no.: 6.561-5001.02-4
Rev. 3 - Date: 09 - February 2005

[< back](#)



SOD-57 PACKAGE DIMENSIONS in millimeters (inches)

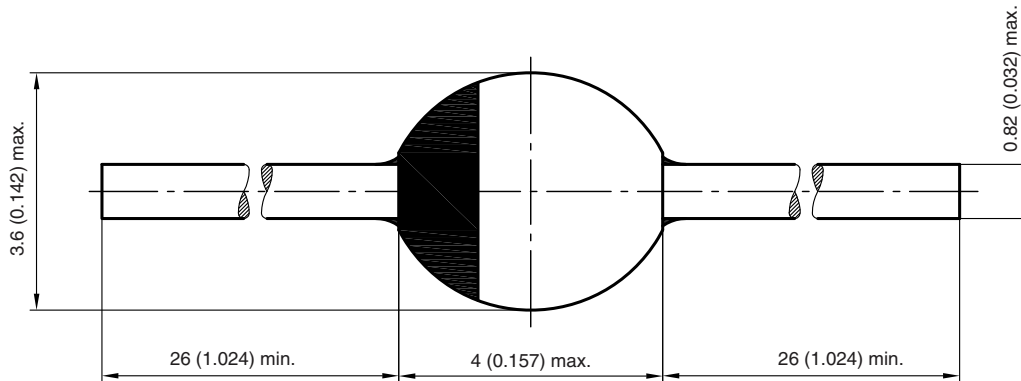

Rev. 3 - Date: 09.February 2005
Document no.:6.563-5006.3-4

[< back](#)

SOD-64 PACKAGE DIMENSIONS in millimeters (inches)

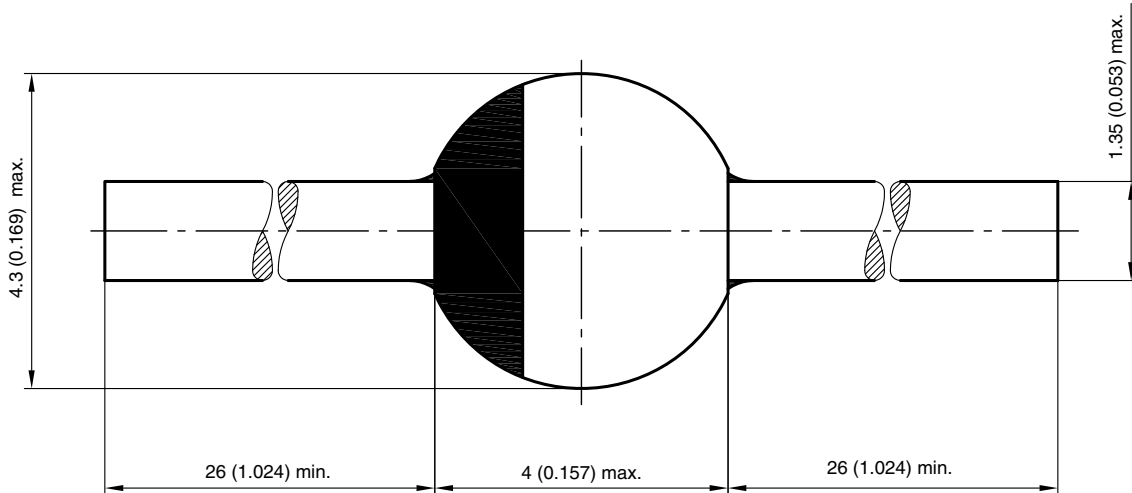

Rev. 3 - Date: 09.February 2005
Document no.:6.563-5006.4-4

[< back](#)