



# Designing the VCNL36826S Into an Application

By Reinhard Schaar

## INTRODUCTION AND BASIC OPERATION

The VCNL36826S is a fully integrated proximity sensor. It combines a high power VCSEL (vertical-cavity surface-emitting laser) and photodiode for proximity measurement and signal processing IC in a single package with a 12-bit ADC. The device provides proximity sensing to minimize accidental touch inputs that can lead to call drops and camera launch.

With a range of up to 20 cm (7.9"), this stand-alone component greatly simplifies the use and design-in of a proximity sensor in consumer and industrial applications, because no mechanical barriers are required to optically isolate the emitter from the detector. The VCNL36826S features a miniature, surface-mount 2.55 mm by 2.05 mm leadless package (LLP) with a low profile of 1 mm. The device is designed specifically to meet the low height requirements of smartphone, mobile phone, digital camera, and tablet PC applications.

Through its standard I<sup>2</sup>C bus serial digital interface, it allows easy access to a "proximity signal". The programmable interrupt function offers wake-up functionality for the microcontroller when a proximity change occurs, which reduces processing overhead by eliminating the need for continuous polling.



Fig. 1 - VCNL36826S Top View

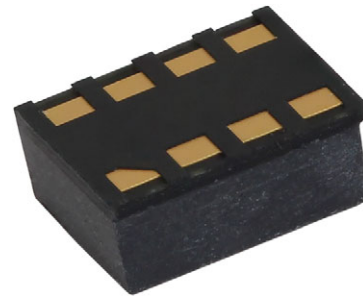

Fig. 2 - VCNL36826S Bottom View

## COMPONENTS (BLOCK DIAGRAM)

The major components of the VCNL36826S are shown in the block diagram.

In addition to the ASIC with the proximity photodiode, the VCSEL emitter is also implemented. Its cathode is connected to the driver internally and need not be connected externally.

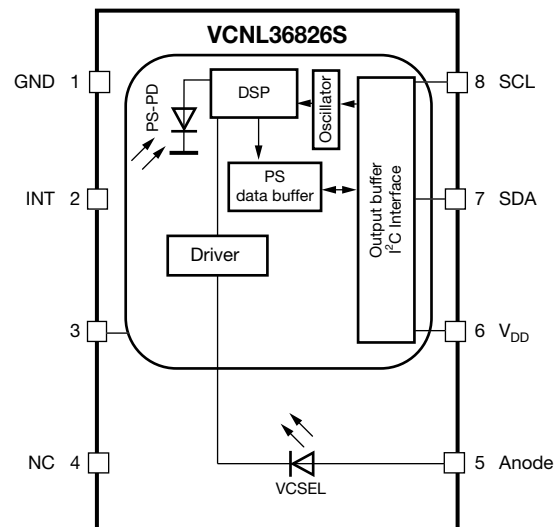

Fig. 3 - VCNL36826S Detailed Block Diagram

APPLICATION NOTE

The DNA of tech.®

## Designing the VCNL36826S Into an Application

The integrated VCSEL emitter has a peak wavelength of 940 nm. It emits light that reflects off an object within 20 cm of the sensor. An added lens helps to increase peak intensity due to enabling a small angle of just  $\pm 3^\circ$ , as shown in Fig. 4.

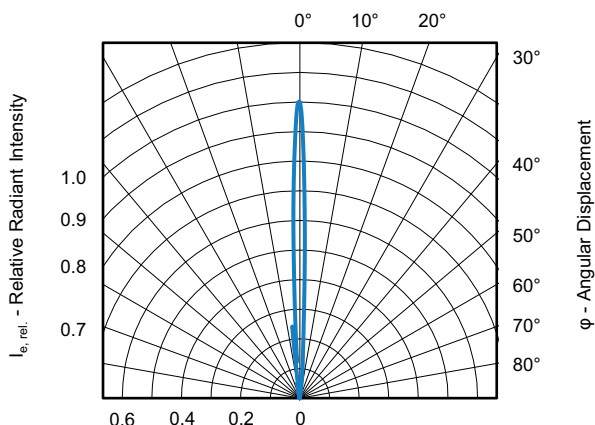

Fig. 4 - Angle of Half Intensity of the Emitter

The VCSEL emitter has a programmable drive current from 6 mA to 20 mA in eight steps. The infrared light is emitted in short pulses with a programmable period time from 10 ms to 80 ms. The proximity photodiode receives the light that is reflected off the object and converts it to a current. It has a peak sensitivity of 850 nm. The sensitivity of the proximity stage is also programmable by choosing from four different integration times. It is insensitive to ambient light. It ignores the DC component of light and “looks for” the pulsed light at the proximity frequency used by the emitter.

The application-specific integrated circuit, or ASIC, includes a VCSEL driver, I<sup>2</sup>C bus interface, amplifier, integrated analog-to-digital converter, oscillator, and signal processor. For proximity, it converts the current from the photodiode to a 12-bit digital data output value.

### PIN CONNECTIONS

Fig. 3 shows the pin assignments of the VCNL36826S.

The connections include:

- Pin 1 - connect to ground
- Pin 2 - INT to microcontroller
- Pin 3 - NC or connect to ground
- Pin 4 - NC
- Pin 5 - V<sub>DD</sub> to the power supply
- Pin 6 - V<sub>DD</sub> to the power supply
- Pin 7 - SDA to microcontroller
- Pin 8 - SCL to microcontroller

The power supply for the ASIC (V<sub>DD</sub>) has a defined range from 2.62 V to 3.6 V. The VCSEL needs also to be connected to same supply between 2.62 V and 3.6 V depending on the required current, see detailed description with the datasheet.

On common power supply, for the V<sub>DD</sub> and the VCSEL one ceramic 1 μF should be placed close to the pin 5 and pin 6. The SCL and SDA, as well as the interrupt lines, need pull-up resistors. The resistor values depend on the application and on the I<sup>2</sup>C bus speed. Common values are about 2.2 kΩ to 4.7 kΩ for the SDA and SCL, and about 8.2 kΩ to 22 kΩ for the interrupt lines.

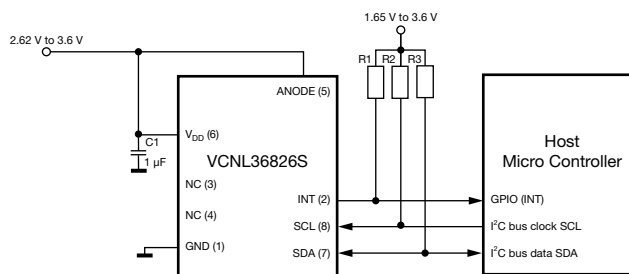

Fig. 5 - VCNL36826S Application Circuit

The DNA of tech.®

## Designing the VCNL36826S Into an Application

### MECHANICAL DESIGN CONSIDERATIONS

The VCNL36826S does not require a mechanical barrier. The signal processor continuously compensates for the light reflected from windows, thus ensuring a proper proximity reading. As a fully integrated sensor, the design process is greatly simplified.

The only dimensions that the design engineer needs to consider are the distance from the top surface of the sensor to the outside surface of the window, and the size of the window. These dimensions will determine the size of the detection zone.

The angle of half intensity of the emitter is about  $\pm 3^\circ$ , as shown in Fig. 6, and the sensitivity of the photodiode is showing about  $\pm 55^\circ$ .

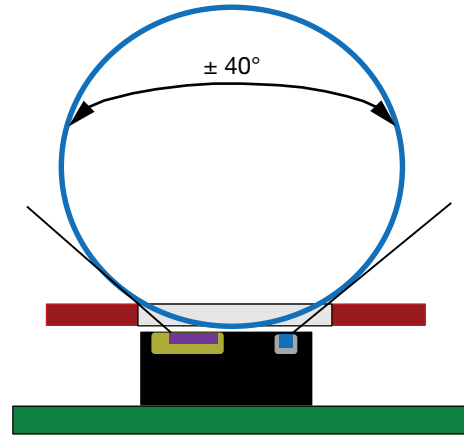

Fig. 8 - Emitter and Detector Angle

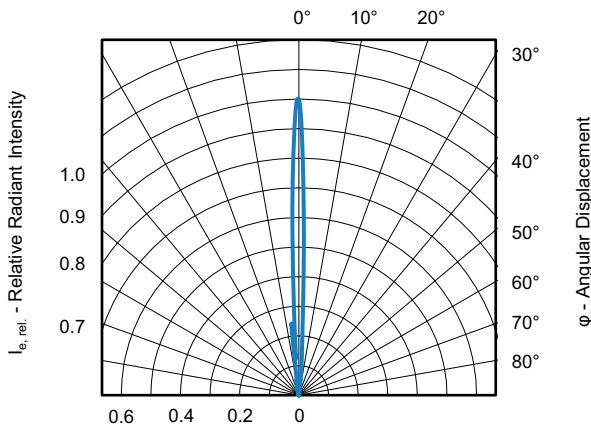

Fig. 6 - Angle of the Half Intensity of the Emitter

To achieve good performance, the diameter of the hole within the cover glass should not be too small. An angle of  $\pm 40^\circ$  will be sufficient in most applications. The package drawing shows the position of the VCSEL and photosensitive area. The  $\pm 40^\circ$  lines are set to outer edges of the photodiode and VCSEL. The following are dimensions for the distance from the top surface of the sensor to the outside surface of the glass,  $a$ , and the width of the window,  $d$ .

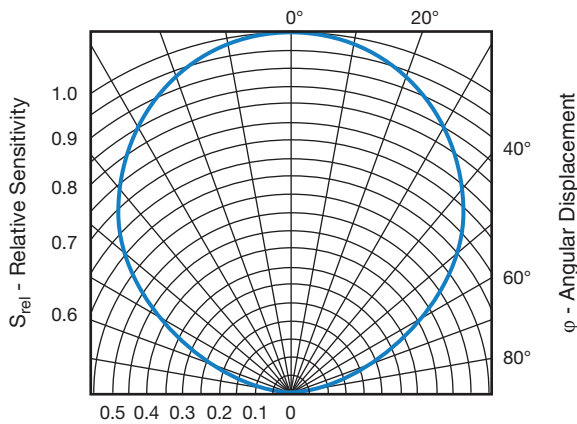

Fig. 7 - Angle of the Half Sensitivity of the Photodiode

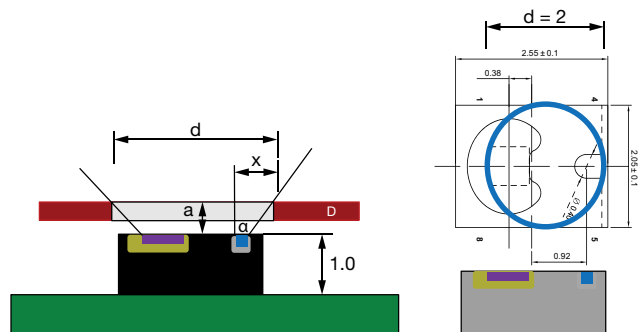

Fig. 9 - Window Dimensions for One Hole

For a single round hole, the diameter should be at least wide enough that the openings can freely look through; so, about 2 mm.

The DNA of tech.®

## Designing the VCNL36826S Into an Application

The diameter needs to be increased with distances between the sensor and cover glass according to the following calculation.

The width calculation for distances from 0.5 mm to 1.5 mm results in:

$a = 0.5 \text{ mm} \rightarrow x = 0.42 \rightarrow d = 2 \text{ mm} + 0.84 = 2.84 \text{ mm}$   
 $a = 1.0 \text{ mm} \rightarrow x = 0.84 \rightarrow d = 2 \text{ mm} + 1.68 = 3.68 \text{ mm}$   
 $a = 1.5 \text{ mm} \rightarrow x = 1.26 \rightarrow d = 2 \text{ mm} + 2.52 = 4.52 \text{ mm}$

Calculation is:  $\tan \alpha = x/a \rightarrow$  with  $\alpha = 40^\circ$  and  $\tan 40^\circ = 0.84 = x/a \rightarrow x = 0.84 \times a$ . Then total width / diameter for the opening is  $d = 2 \text{ mm} + 2 \times x$ .

The results above represent the ideal diameters of the window. The mechanical design of the device may not allow for these diameters. Fig. 9 shows that also a smaller opening could be used. To allow for this, the gap between sensor and cover should be as small as possible ( $\leq 0.2 \text{ mm}$ ) and the cover also quite thin ( $\leq 0.6 \text{ mm}$ ).

### PROXIMITY SENSOR

The main DC light sources found in the environment are sunlight and tungsten (incandescent) bulbs. These kinds of disturbance sources will cause a DC current in the detector inside the sensor, which in turn will produce noise in the receiver circuit. The negative influence of this DC light can be reduced by optical filtering, but is reduced much more efficiently by a so-called DC kill function. The proximity photodiode shows its best sensitivity at about 850 nm, as shown in Fig. 10.

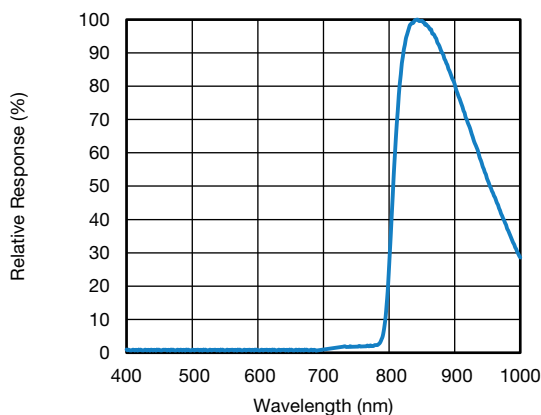

Fig. 10 - Spectral Sensitivity of the Proximity Photodiode

The proximity sensor uses a short pulse signal of about  $50 \mu\text{s}$  ( $\text{PS\_IT} = 1\text{T}$ ) up to  $400 \mu\text{s}$  ( $\text{PS\_IT} = 8\text{T}$ ).  $\text{PS\_ITB}$  sets the duration of T in  $\text{PS\_IT}$ . It is recommended to set  $\text{PS\_ITB}$  to  $50 \mu\text{s}$  because it improves the sensitivity and sunlight protection of the sensor. The period time for this single pulse can be programmed between 10 ms and 80 ms.

In addition to DC light source noise, there is some reflection of the infrared emitted light off the surfaces of the components surrounding the VCNL36826S. The distance to the cover, proximity of surrounding components, tolerances of the sensor, defined infrared emitter current, ambient temperature, and type of window material used all contribute to this reflection. The result of the reflection and DC noise is the production of an output current on the proximity and light sensing photodiode. This current is converted into a count called the offset count.

In addition to the offset count, there could also be a small noise floor during the proximity measurement, which comes from the DC light suppression circuitry. This noise is typically just one or two counts. Only with light sources with strong infrared content could it be in the range from  $\pm 5$  counts to  $\pm 10$  counts.

The application should “ignore” this offset and small noise floor by subtracting them from the total proximity readings. The VCNL36826S offers a subtraction feature that automatically does this:  $\text{PS\_CANC}$ . During the development of the end product, this offset count is evaluated and may now be written into register 7:  $\text{PS\_CANC\_L/H}$ . Now the proximity output data will just show the subtraction result of proximity counts - offset counts.

Results most often do not need to be averaged. If an object with very low reflectivity or at longer range needs to be detected, the sensor provides a register where the customer can define the number of consecutive measurements that the signal must exceed before producing an interrupt. This provides stable results without requiring averaging.



The DNA of tech.®

## Designing the VCNL36826S Into an Application

### PROXIMITY CURRENT CONSUMPTION

The VCNL36826S is in shutdown by default. It can be turned on by setting PS\_ON = 1, PS\_INIT = 1, and PS\_ST = 0.

The VCNL36826S's embedded VCSEL driver drives the internal VCSEL with a pulsed duty cycle. The VCSEL on / off duty ratio is programmable by an I<sup>2</sup>C command at register PS\_Period. Depending on this pulse / pause ratio, the overall proximity current consumption can be calculated. When higher measurement speed or faster response time is needed, PS\_Period may be selected to a short time of 10 ms, but this will then also lead to the highest current consumption:

PS\_Period = 10 ms: peak VCSEL current = 20 mA, PS\_IT = 1T = 50 μs, averaged current consumption is 20 mA x 50 μs/10 000 μs = 0.1 mA.

For proximity measurements executed just every 80 ms: PS\_Period = 80 ms, peak VCSEL current = 20 mA, averaged current consumption is 20 mA x 50 μs/80 000 μs = 0.0125 mA.

Another way to execute proximity measurements is to apply a PS active force mode (register: PS\_CONF3\_L, command: PS\_AF = 1).

If only a single proximity measurement needs to be done, PS\_AF is set to "1" and then PS\_ST = 0 = active. Setting PS\_Trig = 1 will then execute just one single measurement.

In this mode, only the I<sup>2</sup>C interface is active. In most consumer electronic applications the sensor will spend the majority of time in sleep mode; it only needs to be woken up for a proximity measurement.

This "active force" mode may be used for even faster measurements than are possible with the self-timed mode. If lowest possible power consumption is needed, the device should be switched off with 1. PS\_ST = 1 and 2. PS\_ON = 0 after every measurement.

### "LOW POWER CONSUMPTION" MODE

With register PS\_LPEN set to 1, the proximity sensor operates in a special low power consumption mode offering significant lower power consumption.

This is a remarkable feature for any application requiring lower power consumption and did not want to always request one proximity measurement with proximity force mode: PS\_AF and PS\_TRIG.

The proximity period within this mode is possible to set between 40 ms and 320 ms, means, 25 measurements down to just 3 measurements per second can be programmed where the "normal mode" with PS\_Period allows only for settings between 10 ms and 80 ms.

PS period (ms)	10	20	40	80	160	320
Normal mode (μA)	600.00	400.00	300.00	250.00	n/a	n/a
Low power mode (μA)	n/a	n/a	107.00	56.00	30.50	17.75

#### Note

- VCSEL\_I = 10 mA; PS\_IT = 8T

The DNA of tech.®

## Designing the VCNL36826S Into an Application

With PS\_LPEN = 1 = enabled, proximity low power measurements will start. In this case values programmed to PS\_LPPER will be used as period. VCSEL\_I, PS\_IT, PS\_ITB and PS\_MPS will be used as defined within register 3 and register 4.

TABLE 12 - REGISTER: PS_CONF4_H DESCRIPTION										
COMMAND CODE: 0x08_H (0x08 DATA BYTE HIGH)										
Register	Bit	Description								
Reserved	7 : 3	Default = (0 : 0 : 0 : 0 : 0)								
PS_LPPER	2 : 1	(0 : 0) = 40 ms, (0 : 1) = 80 ms, (1 : 0) = 160 ms, (1 : 1) = 320 ms; PS detection period setting at low power mode (PS_LPEN = 1)								
PS_LPEN	0	0 = disable, 1 = enable = starts proximity low power measurements; now PS_LPPER used as period, but VCSEL_I, PS_IT, PS_ITB, PS_MPS as defined within register 3 and register 4								
		PS_IT = 50 $\mu$ s; PS_LPPER period (ms)				PS_IT = 200 $\mu$ s; PS_LPPER period (ms)				
ILED (mA)		40	80	160	320	ILED (mA)	40	80	160	320
6		12.75	8.88	6.94	5.97	6	36.00	20.50	12.75	8.88
8		15.25	10.13	7.56	6.28	8	46.00	25.50	15.25	10.13
10		17.75	11.38	8.19	6.59	10	56.00	30.50	17.75	11.38
12		20.25	12.63	8.81	6.91	12	66.00	35.50	20.25	12.63
14		22.75	13.88	9.44	7.22	14	76.00	40.50	22.75	13.88
16		25.25	15.13	10.06	7.53	16	86.00	45.50	25.25	15.13
18		27.75	16.38	10.69	7.84	18	96.00	50.50	27.75	16.38
20		30.25	17.63	11.31	8.16	20	106.00	55.50	30.25	17.63

With low power mode applied, VCNL36826S current consumption reach to minimum of 6  $\mu$ A with longest response time of 320 ms, lowest VCSEL current of 6 mA and shortest integration time of PS\_IT = 50  $\mu$ s.

A maximum of 106  $\mu$ A is seen when using with the fast response time of 40 ms, highest VCSEL current of 20 mA and longest integration time of PS\_IT = 200  $\mu$ s.

The pulse length of PS\_IT = 1T is 50  $\mu$ s. Amplitude of that 50  $\mu$ s pulse is dependent on the VCSEL current. The higher this current is programmed, the higher that pulse amplitude will be. Taking a scope picture with added series resistor within power supply line will look like this:

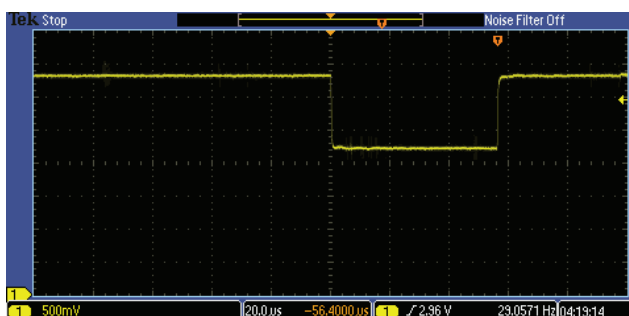

Fig. 11 - Proximity VCSEL Pulse for 1T



The DNA of tech.®

## Designing the VCNL36826S Into an Application

### INITIALIZATION AND I<sup>2</sup>C TIMINGS

The VCNL36826S contains eleven 16-bit command codes for operation control, parameter setup, and result buffering. All registers are accessible via I<sup>2</sup>C communication. The built-in I<sup>2</sup>C interface is compatible with the standard and high-speed I<sup>2</sup>C modes. The I<sup>2</sup>C H-level voltage range is from 1.65 V to 3.6 V.

There are only four registers out of the eleven that typically need to be defined:

1. VCSEL\_I = 6 mA to 20 mA (VCSEL current), and PS\_HD = 12 Bits / 16 Bits (PS Output) <sup>(1)</sup> REGISTER CONF4 #04 [0x04h]

**Note**

<sup>(1)</sup>16 Bits can be used to increase dynamic range but can't be used with threshold interrupt, which limited to 12 bits

2. PS\_Period = 6 ms to 20 ms (proximity duty ratio), PS\_IT (proximity integration time = pulse length), PS\_ITB = 50 μs (IT Bank setting of 50μs recommended for better sensitivity). PS\_PERS (number of consecutive measurements above / below threshold), and PS\_ST (PS start) REGISTER PS\_CONF2\_L and PS\_CONF2\_H #03 [0x03h]

3. and 4. Definition of the threshold value from the number of counts the detection of an object should be signaled. This is limited to 12 Bits PS output only. Therefore, threshold with interrupt cannot be used with 16 Bits PS output. Proximity TOP Threshold REGISTER PS\_THDL\_L #05 [0x05h] for the low byte and PS\_THDL\_H #06 [0x06h] for the high byte.

To define the VCSEL current, as well as the integration time (length of the proximity pulsing), evaluation tests should be performed using the least reflective material at the maximum distance specified.

Fig. 12 shows the typical digital counts output versus distance for three different emitter currents for integration time 1T. The reflective reference medium is the Kodak Gray card. This card shows approximately 18 % reflectivity at 940 nm.

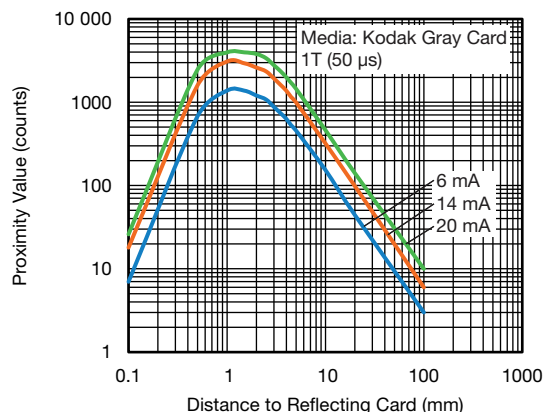

Fig. 12 - Proximity Value vs. Distance for 1T

This first diagram shows the possible detection counts with a short pulse of just 50 μs.

If higher detection distances and / or objects with very low reflectivity need to be detected, there is the option to extend these proximity pulses up to about 400 μs for 8T. This results in higher counts but may also lead to saturation effects for very close and very bright objects. This leads then to the diagram in Fig. 13 below.

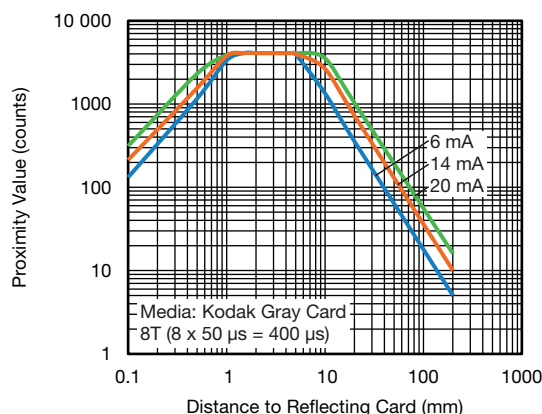

Fig. 13 - Proximity Value vs. Distance; PS\_IT = 8T

With defining the period time (PS\_Period), the repetition rate = the number of proximity measurements per second (speed of proximity measurements) is defined. This is possible between 10 ms (about 90 measurements/s) and 80 ms (about 12 measurements/s).

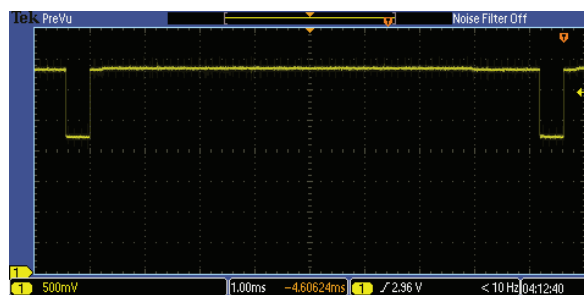

Fig. 14 - Proximity Measurements with PS\_Period = 10 ms

The DNA of tech.®

## Designing the VCNL36826S Into an Application

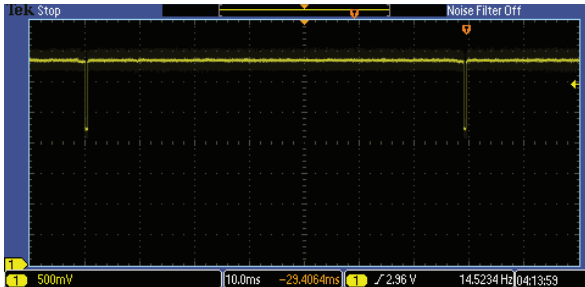

Fig. 15 - Proximity Measurements with PS\_Period = 80 ms

This duty cycle also determines how fast the application reacts when an object appears in, or is removed from, the proximity zone.

Reaction time is also determined by the number of counts that must be exceeded before an interrupt is set. This is possible to define with proximity persist: PS\_PERS. Possible values are from 1 to 4.

To eliminate disturbance by direct sunlight these “sunlight cancellation” bits PS\_SC need to be set.

To define all these register values, an evaluation test should be performed. These tests can be made just using the VCNL36826S sensor board together with the SensorXplorer™. Both boards are available from any of Vishay’s distributors.

Please see:

[www.vishay.com/optoelectronics/SensorXplorer](http://www.vishay.com/optoelectronics/SensorXplorer).

### Timing

For an I<sup>2</sup>C bus operating at 100 kHz, to write or read an 8-bit byte, plus start (or stop) and bit acknowledgement, takes 100 μs. Together with the slave address byte and the 8-bit command code byte, plus the 16-bit data, this results in a total of 400 μs. When the device is powered on, the initialization with just these five registers needs 5 x 4 bytes (slave address, command register, and 16-bit data) for a total of 20 bytes. So, 20 x 100 μs = 2000 μs = 2 ms.

Send Byte → Write Command to VCNL36826S

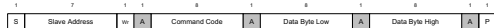

The read-out of 16-bit data would take a total of five bytes (slave address, command code, slave address with read bit set) and 16-bit data sent from the VCNL36826S. So, 500 μs:

Receive Byte → Read Data from VCNL36826S



### Power Up

The release of the internal reset, the start of the oscillator, and the signal processor need **2.5 ms**

### Initialize Registers

Write to four registers **1600 μs**

- VCSEL current
- Proximity duty ratio
- Proximity interrupt TOP threshold

Once the device is powered on and the VCNL36826S is initialized, a proximity measurement can be taken.

Asking for one forced proximity measurement **400 μs**

For (active forced, PS\_IT = 8)

Time to trigger [0.5 x PS\_IT] **200 μs**

DC-kill ambient light [3 x PS\_IT] **1200 μs**

Proximity measurement [1 x PS\_IT] **400 μs**

VCSEL shutdown [1 x PS\_IT] **400 μs**

Read out of the proximity data **500 μs**

total: **3100 μs**

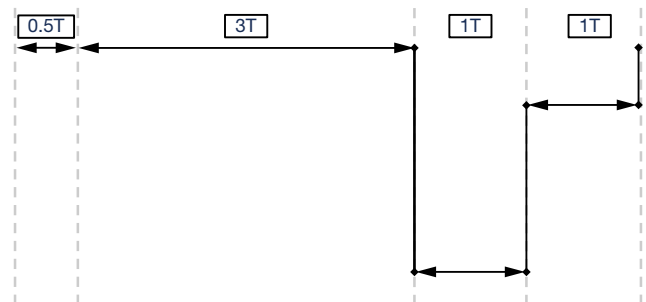

Fig. 16 - Timing Specification for Active Forced Mode





The DNA of tech.®

## Designing the VCNL36826S Into an Application

### INITIALIZATION STEPS

It is recommended to follow the following initialization steps to start the most basic proximity measurements using default parameters:

1. Do the reset using recommended default values (so that the register will start with default values and will not affect the setting of the sensor)

```

PS_CONF1_L = 0x01
PS_CONF1_H = 0x00
PS_CONF2_L = 0x00
PS_CONF2_H = 0x00
PS_CONF3_L = 0x00
PS_CONF3_H = 0x00

```

... the rest = follow the default value like in the datasheet page 8. Only do for registers that can do R/W only

2. Initialize the sensor by setting:

- I. PS\_ON = 1
- II. (Bit 0 register PS\_CONF1\_L always stays 1)
- III. PS\_INIT = 1

#### Note

- Will immediately turn to 0 and will be read as 0 when you read this register

- IV. (Bit 1 register PS\_CONF1\_H need to be set to 1)
- V. PS\_ST = 0

3. Read proximity data register 0xF8

#### Note

- The above register values are intended / valid for the most basic / default values to turn on the sensor. If different sensor parameters (e.g. different VCSEL current / integration time etc. are being chosen, the values of the register when being read will be different

### INTERRUPT

The VCNL36826S features a very intelligent interrupt function. The interrupt function enables the sensor to work independently until a predefined proximity event or threshold occurs. It then sets an interrupt which requires the microcontroller to awaken. This helps customers reduce their software effort, and reduces power consumption by eliminating polling communication traffic between the sensor and microcontroller.

The interrupt pin, pin 2, of the VCNL36826S should be connected to a dedicated GPIO of the controller. A pull-up resistor is added to the same power supply that the controller is connected to. This INT pull-up resistor may be in the range of 8.2 kΩ to 100 kΩ.

The events that can generate an interrupt include:

1. A lower and an upper threshold for the proximity value can be defined. If the proximity value falls below the lower limit or exceeds the upper limit, an interrupt event will be generated. In this case, an interrupt flag bit in the read-out register 0xF9 will be set and the interrupt pad of the VCNL will be pulled to low by an open drain pull-down circuit. In order to eliminate false triggering of the interrupt by noise or disturbances, it is possible to define the number of consecutive measurements that have to occur before the interrupt is triggered
2. A too high infrared level as it could be with strong direct sunlight or also close halogen / incandescent lamp can be observed with checking the bit: PS\_SPFLAG

### Application Example

The following example will demonstrate the ease of using the VCNL36826S sensor.

#### Offset

During development, the application-specific offset counts for the sensor were determined. As previously mentioned, the offset count is affected by the components surrounding the VCNL36826S, the window or cover being used, the distance from the sensor to the cover, and emitter intensity, which is controlled by the forward current.

In the following example, with a cover over the sensor and setting the emitter current to 20 mA and with PS\_MPS = 8 pulses, the offset counts are 300 counts (Fig. 17). Offset counts vary by application and can be anywhere from 0 counts to several hundred counts. It is important to note that the offset count may change slightly over time due to, for example, the window becoming scratched or dirty, or being exposed to high-temperature changes. If possible, the offset value should occasionally be checked and, if necessary, modified.

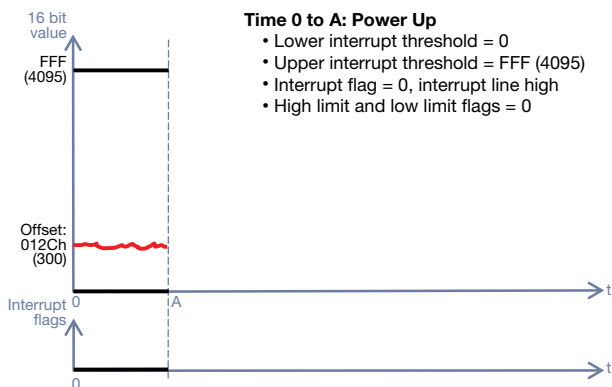

Fig. 17

The DNA of tech.®

## Designing the VCNL36826S Into an Application

### Power Up

As mentioned, there are four variables for proximity measurement that need to be set in the register when the sensor is powered up: the emitter current, the number of occurrences that must exceed a threshold to generate an interrupt, the threshold values, and the number of proximity measurements per second.

The sensor should detect skin at a distance of 5 cm. Development testing determined that a current of 20 mA produces adequate counts for detection. The proximity measurement rate is set so that about 14 measurements are done within a second and the number of occurrences to trigger an interrupt is set to four. Based on development testing, with a hand or skin approximately 5 cm above the window cover, the resulting total count is > 500. This will be used as the upper threshold (high threshold).

For smartphone applications it would be typical to initially set this top threshold and a lower threshold (bottom threshold). This is needed to indicate the removal of the phone from the user's ear. The measured counts without any additional object close by will be around this offset count value, always below the lower threshold value, as shown in Fig. 18.

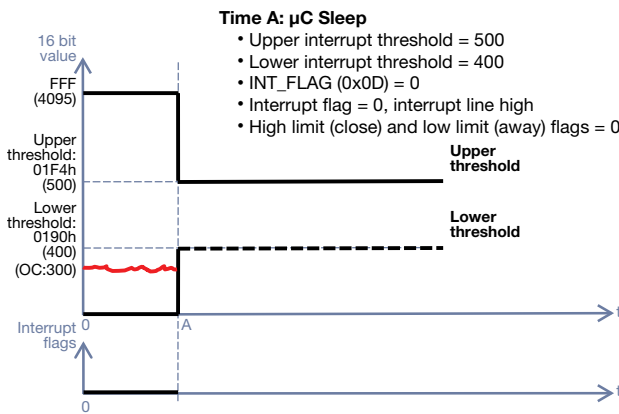

Fig. 18

By setting the number of occurrences before generating an interrupt to 4, a single proximity value above or below the thresholds will have no effect, as shown in Fig. 19.

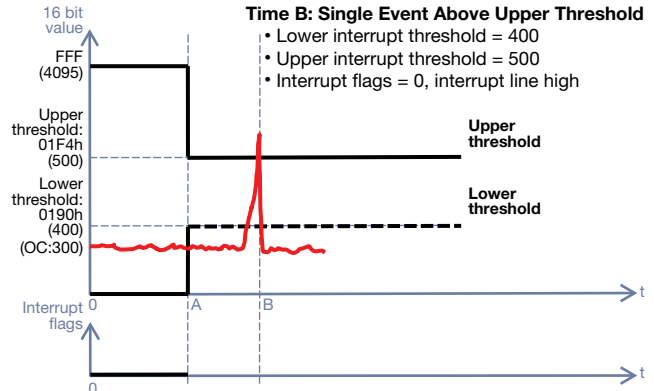

Fig. 19

A smartphone application will use a proximity sensor to detect when the phone is brought to the user's ear and disable the touchscreen and turn off the backlight. For other applications, such as automatic dispensing, the soap or towel will be dispensed.

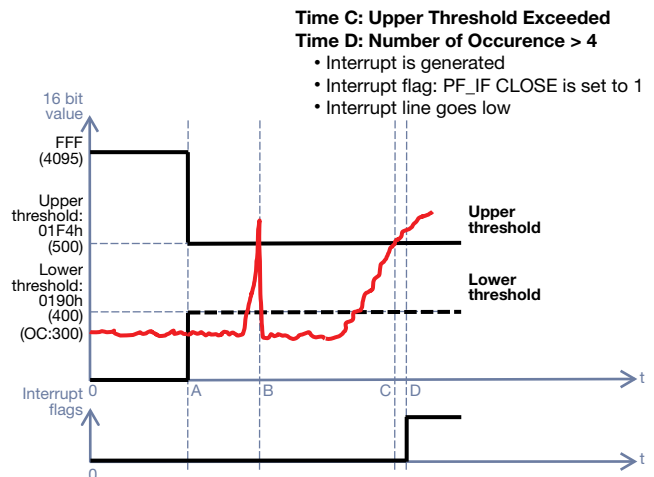

Fig. 20

In smartphone applications, the bottom threshold will also be programmed and wait for an interrupt signal. The prox\_threshold\_bottom should be set to "1" now and the prox\_threshold\_top cleared by entering a "1" again, since the phone is already next to the user's ear. A lower threshold will occur when the phone call is complete and the phone is brought away from the user's ear, and the backlight and touchscreen will be turned back on.

For this example, the upper threshold will be set to 500 counts. The lower threshold is set to 400 counts; a value that is higher than the offset but low enough to indicate the removal of the phone from the user's ear.



The DNA of tech.®

# Designing the VCNL36826S Into an Application

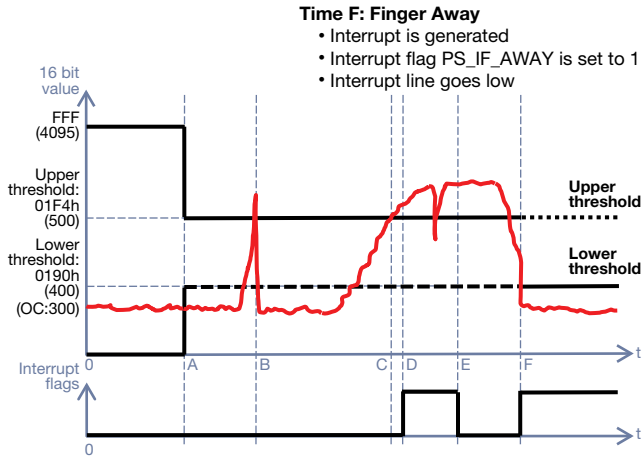

Fig. 21

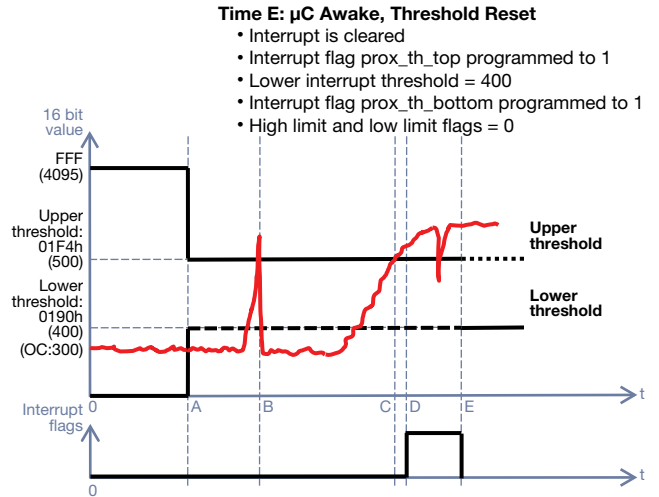

Fig. 22



The DNA of tech.®

## Designing the VCNL36826S Into an Application

### Interrupt Mode

TABLE 13 - INTERRUPT REGISTER DESCRIPTION				
Register	Command	Command Code	Bit	Description
PS_CONF2_L	PS_INT	0x03_L (0x03 data byte low)	3 : 2	(0 : 0) = interrupt disable, (0 : 1) = logic high / low mode, (1 : 0) = first high, (1 : 1) = interrupt enable
INT_Flag	-	0xF9_H (0xF9 data byte high)	7 : 6 5 4 3 2 1 0	Reserved PS_ACFLAG, after PS finishing auto-calibration, INT raise PS_SPFLAG, PS entering protection mode Reserved Reserved PS_IF_CLOSE, PS rises above PS_THDH INT trigger event PS_IF_AWAY, PS drops below PS_THDL INT trigger event

VCNL36826S has three interrupt modes which are “normal” interrupt mode, “first high” mode, and “logic high / low” mode. User has to set the bit 3 : 2 within the register PS\_CONF2\_L. The description of each of the interrupt mode is as follows:

1. The “logic high / low” interrupt mode is selected with PS\_INT = trigger by logic high/low mode (0x03\_L, bit 3 : 2 = 0 : 1) within register PS\_CONF2\_L. When this mode is selected, the interrupt pin is pulled low (logic high) when the proximity counts reach the programmed high threshold (PS\_THDH) and will return to a high level (logic low) when counts drop below the count value for low threshold (PS\_THDL). There is no corresponding interrupt flag for this mode.
2. The “first high” interrupt mode is selected with PS\_INT = first high (0x03\_L, bit 3 : 2 = 1 : 0) within register PS\_CONF2\_L. In this mode, the initial interrupt event that is triggered needs to be with regard to the high threshold (PS\_THDH). Passing underneath the low threshold will have no effect until the first high threshold event has occurred. Therefore, the interrupt pin will be pulled low when the proximity counts first increase beyond the programmed high threshold (PS\_THDH), and simultaneously, the interrupt flag in the interrupt register will be set to “1”. On the other hand, after the first PS\_THDH event, the interrupt pin will also be pulled low when the proximity counts drop below the programmed low threshold (PS\_THDL) and simultaneously, the interrupt flag in the interrupt register will be set to “1”. The interrupt line will be pulled high again and the interrupt flag will be cleared to “0” once the interrupt register has been read.
3. The “normal” interrupt mode is selected with PS\_INT = interrupt enabled (0x03\_L, bit 3 : 2 = 1 : 1) within register PS\_CONF2\_L. When this mode is selected, the interrupt pin will be pulled low when the proximity counts increase beyond the programmed high threshold (PS\_THDH), and simultaneously, the interrupt flag in the interrupt register will be set to “1”. On the other hand, the interrupt pin will also be pulled low when the proximity counts drop below the programmed low threshold (PS\_THDL), and simultaneously, the interrupt flag in the interrupt register will be set to “1”. The interrupt line will be pulled high again and the interrupt flag will be cleared to “0” once the interrupt register has been read. The sequence which interrupts event that occurs first either PS\_THDH or PS\_THDL does not play a role, unlike the “first high” mode.

The DNA of tech.®

## Designing the VCNL36826S Into an Application

Some measurements and features are shown with the demo tool and demo software with a cover glass at about a 1 mm distance.

1. Proximity set-up with 8T wide pulses, 20 mA VCSEL current, PS\_MPS = 8, and a period of 80 ms, which results in about 15 measurements per second

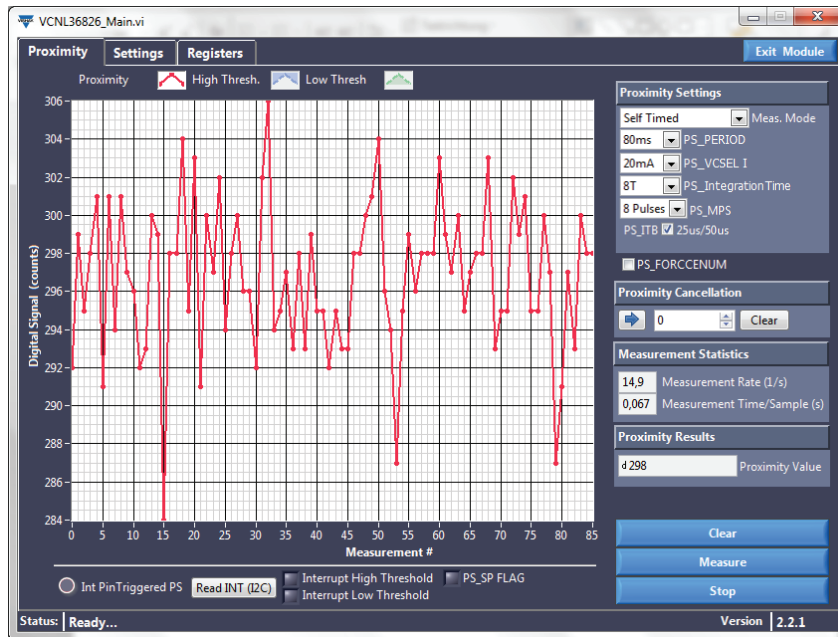

Fig. 23 - Screenshot of VCNL36826 Demo Software

2. If a hand or skin now comes as close as 5 cm, these 300 counts rise up to more than 500 counts.

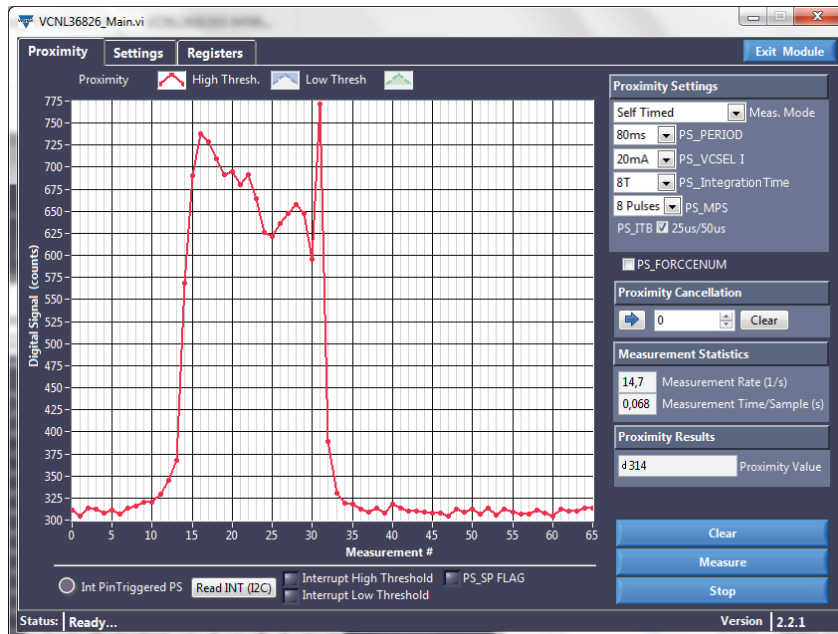

Fig. 24 - Hand in About 5 cm Distance Will Lead to More Than 500 Counts

The DNA of tech.®

## Designing the VCNL36826S Into an Application

- Here the thresholds are programmed as 500 for the upper and 400 for the lower. To see these, both “Show” buttons are activated. The presence of an object should only be recognized when four consecutive measurements are above that threshold.

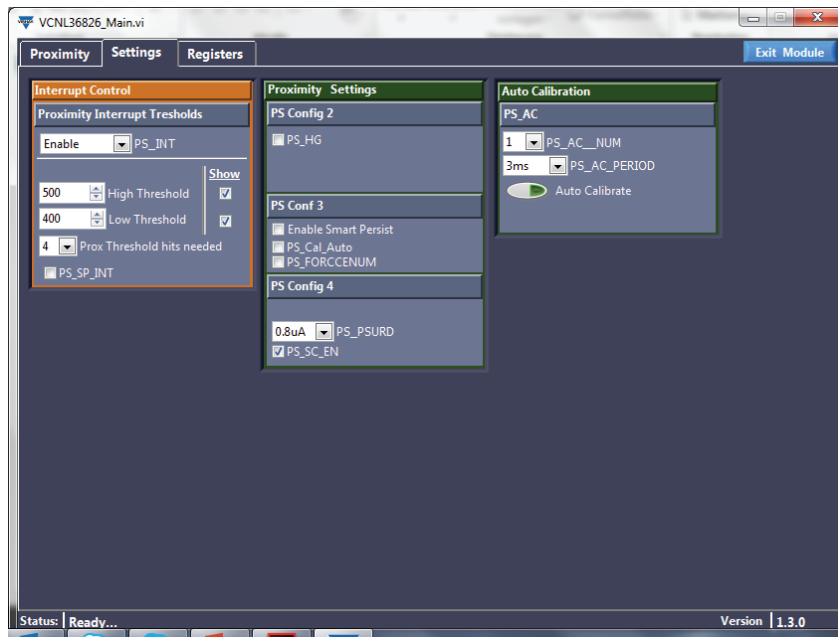

Fig. 25 - “Settings” Menu Within Demo Software

- Just one or two measurements above the threshold will not activate the interrupt.

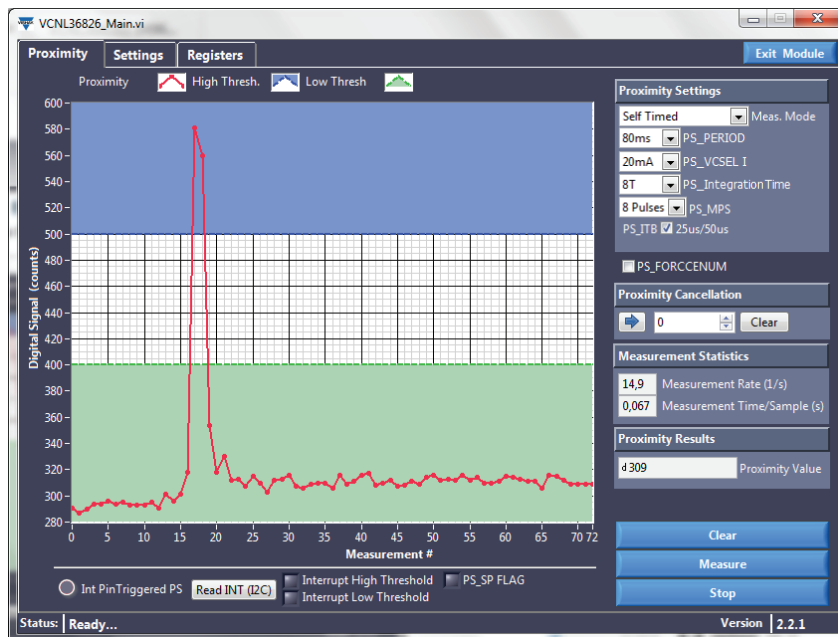

Fig. 26 - Upper and Lower Threshold Set and Hand in About 5 cm Distance



The DNA of tech.®

## Designing the VCNL36826S Into an Application

- With more than four measurements above the threshold, however, the interrupt is pulled low, as indicated by the red LED on the demo board and the red light: “Int Pin Triggered PS.”

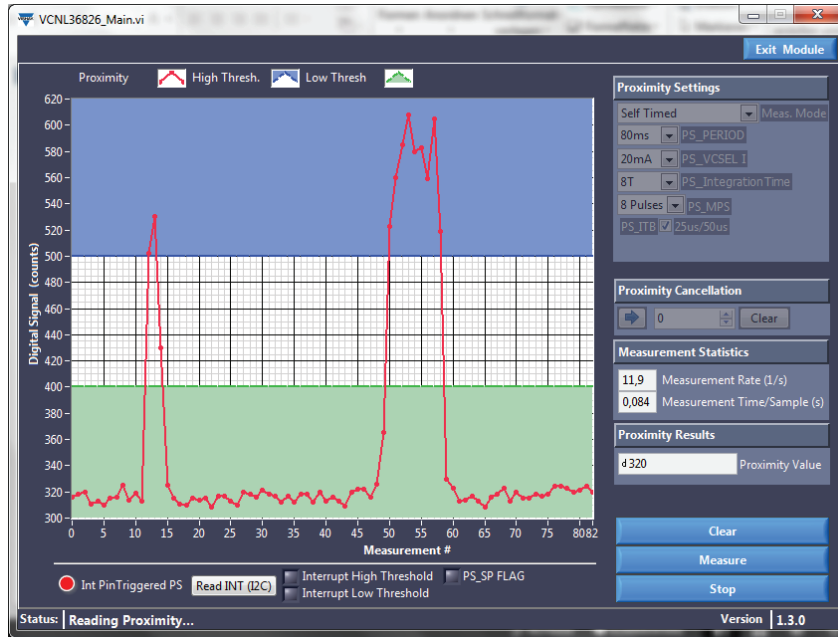

Fig. 27 - Hand in About 5 cm Distance for More Than 4 Consecutive Measurements Above Higher Threshold

- The cancellation feature is used below. The “before seen” offset counts are subtracted. To do so, the value of 300 is entered for register number 05 = Prox\_Cancellation.

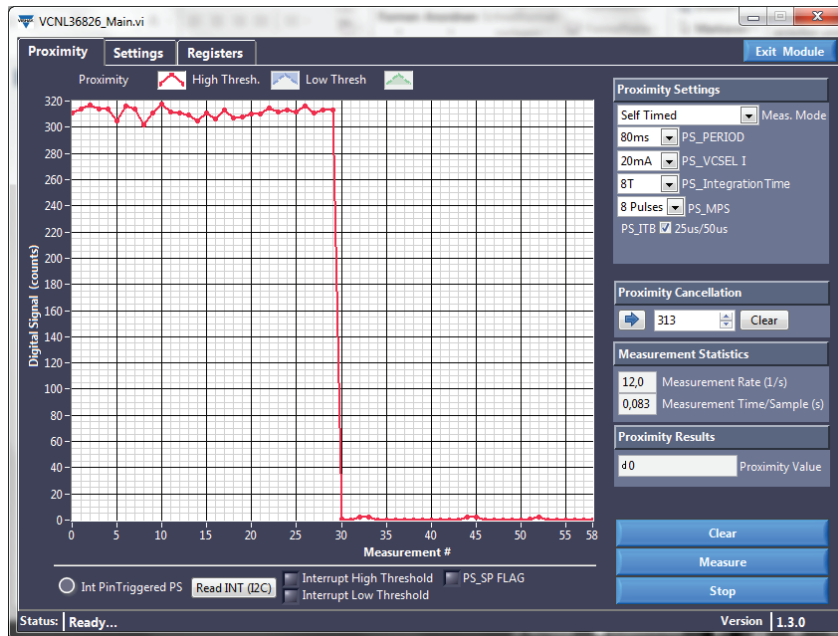

Fig. 28 - Cancellation Activated

The DNA of tech.®

## Designing the VCNL36826S Into an Application

- The “before seen” offset counts of about 300 are now subtracted:  $300 - 300 = 0$ . Also, the thresholds are now 300 counts lower. The higher threshold is 200 and lower is just 100.

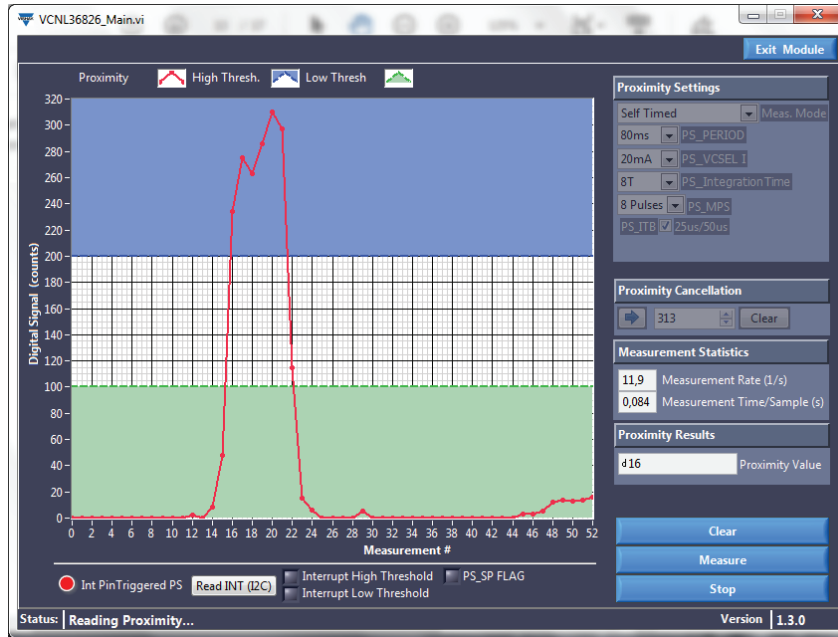

Fig. 29 - New Defined Thresholds With Cancellation Feature

If one chooses “logic mode” now and redefines the high threshold to 200 and low threshold as 100...

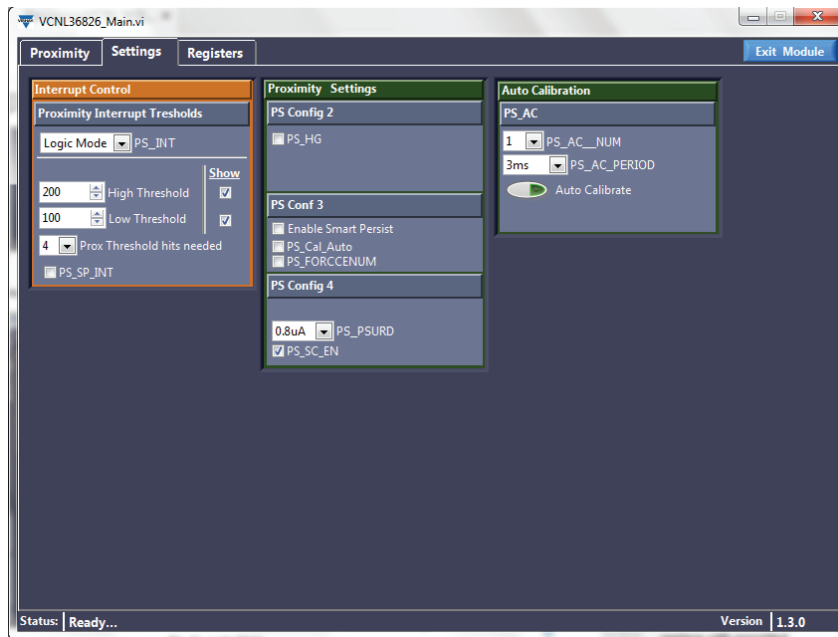

Fig. 30 - Logic Mode

The DNA of tech.®

## Designing the VCNL36826S Into an Application

... the interrupt will indicate the rise above the upper threshold and will also automatically be cleared when it falls below the lower threshold.

### SMART PERSIST

One special feature for faster proximity measurements is also implemented, which is called “smart persist.”

This feature reduces the total reaction time until the interrupt is set to active, although four consecutive measurements should be above (or below) the defined threshold for safe acknowledgment.

Without “smart persist”, but with programmed hits above the defined threshold set to four, it will take three times the time of PS\_Period. With PS\_Period set to 40 ms this would be 3 x 40 ms.

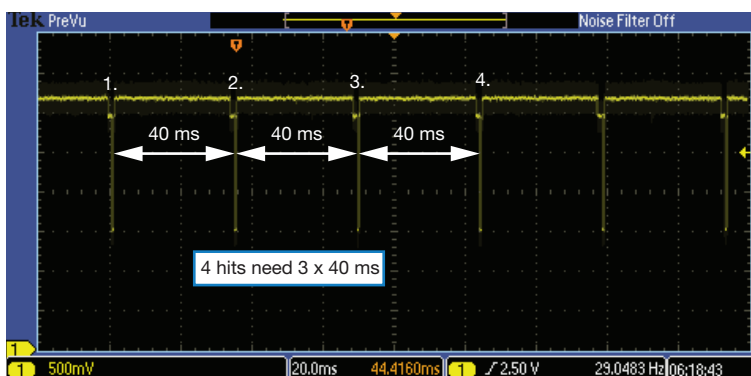
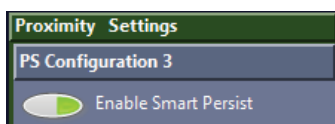

Fig. 31 - Interrupt Active After 4 Hits Above Threshold

With “smart persist” activated (bit 1 of PS\_CONF2\_L):

REGISTER: PS_CONF2_L DESCRIPTION		
REGISTER NAME		COMMAND CODE: 0x03_L (0x03 DATA BYTE LOW)
Command	Bit	Description
PS_Period	7 : 6	(0 : 0) = 10 ms, (0 : 1) = 20 ms, (1 : 0) = 40 ms, (1 : 1) = 80 ms PS sample period setting
PS_PERS	5 : 4	(0 : 0) = 1, (0 : 1) = 2, (1 : 0) = 3, (1 : 1) = 4 PS interrupt persistence setting
PS_INT	3 : 2	(0 : 0) = interrupt disable, (0 : 1) = logic high / low mode, (1 : 0) = first away, (1 : 1) = interrupt enable
PS_SMART_PERS	1	0 = disable PS smart persistence, 1 = enable PS smart persistence
PS_ST	0	0 = PS start, 1 = PS stop, default = 1

or within the demo-tool:



The total needed time is reduced to just about 7 ms.

## Designing the VCNL36826S Into an Application

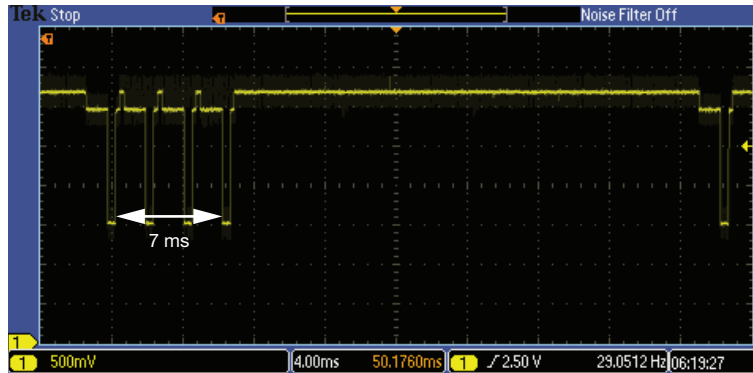

Fig. 32 - Smart Persist With PS\_IT = 8T = 400  $\mu$ s and PS\_Period = 40 ms

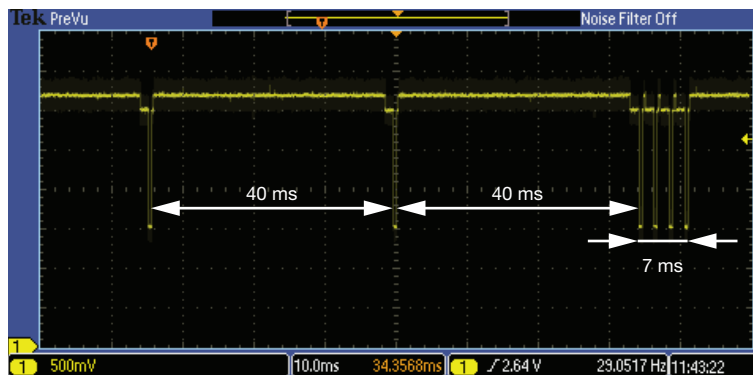

Fig. 33 - Always About 7 ms for These 4 Hits, Also When PS\_Period is Programmed to Just 10 ms

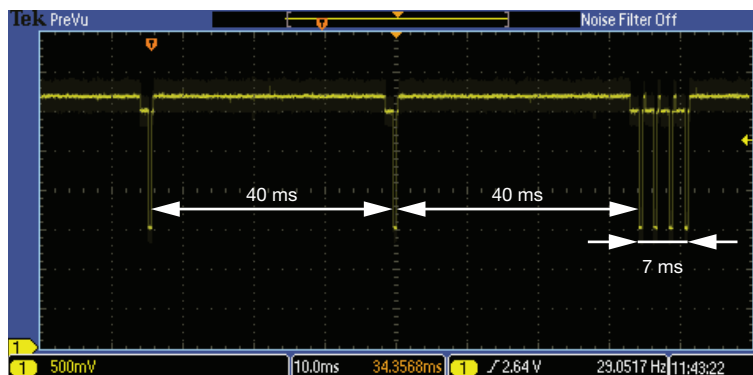

Fig. 34 - Smart Persist With Four Consecutive Proximity Pulses Short After Each Other

### MULTI PULSE FEATURE

For high detection ranges, the intensity for each proximity measurement will be chosen to the maximum possible value. This can be achieved by programming the VCSEL current to a maximum of 20 mA and longest measurement pulse PS\_IT of 400  $\mu$ s. Even further increase is possible using this so-called Multi-Pulse feature, PS\_MPS.

The DNA of tech.®

## Designing the VCNL36826S Into an Application

With this it is possible to send more than one pulse for a single proximity measurement. As shown within the table and illustrated with Fig. 34 and Fig. 35 below, a burst with either 2, 4, or even 8 pulses one after the other is possible.

REGISTER: PS_CONF2_H DESCRIPTION		
COMMAND CODE: 0x03_H (0x03 DATA BYTE HIGH)		
Command	Bit	Description
PS_IT	7 : 6	(0 : 0) = 1T, (0 : 1) = 2T, (1 : 0) = 4T, (1 : 1) = 8T
PS_MPS	5 : 4	(0 : 0 ) = 1, (0 : 1) = 2, (1 : 0) = 4, (1 : 1) = 8; PS multi-pulse setting
PS_ITB	3	0: ITB = 25 $\mu$ s, 1: ITB = 50 $\mu$ s
PS_HG	2	0 = disable, 1 = enable, PS high gain mode
Reserved	1 : 0	Default = (0 : 0)

With PS\_IT of 400  $\mu$ s and PS\_MPS = 8 this needs then about 6 ms for one measurement, see Fig. 34 below. Fig. 35 shows it with 4 pulses and Fig. 36 shows these 8 pulses within a period of 80 ms.

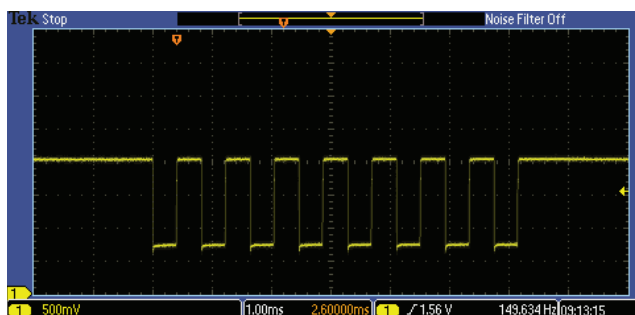

Fig. 35 - PS\_IT = 8T (400  $\mu$ s) and MPS = 8

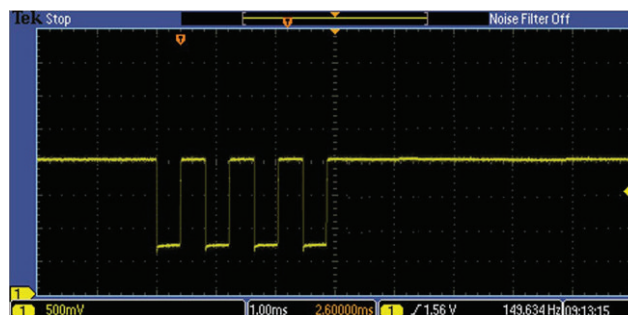

Fig. 36 - PS\_IT = 8T (400  $\mu$ s) and MPS = 4

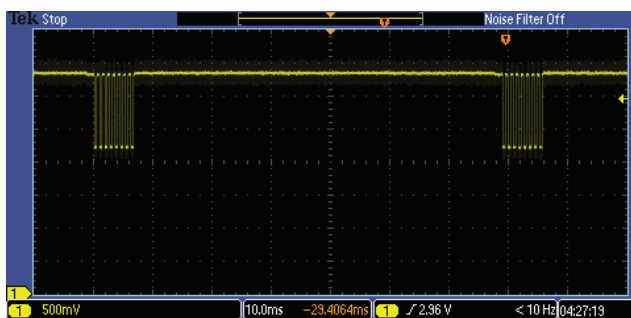

Fig. 37 - PS\_Period = 80 ms and PS\_IT = 8T (400  $\mu$ s) and MPS = 8

With this much higher energy the detection distance could be increased up to about 40 cm (15 inch).

The DNA of tech.®

## Designing the VCNL36826S Into an Application

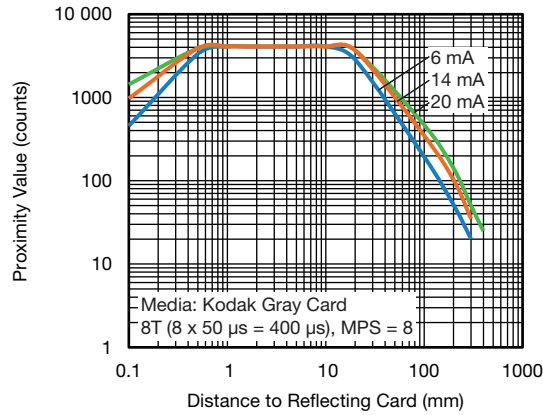

Fig. 38 - Proximity Value vs. Distance for PS\_IT = 8T (400 μs) and MPS = 8

### AUTO CALIBRATION

This new feature offers a direct and internal subtraction of the so-called “offset” counts that are seen when the sensor is built-in within its end application where at least the cover will show significant offset counts.

To use this feature just this “PS\_AC” needs to be set to “1” = enable.

This auto calibration is carried out then with this specific AC parameters that needs to be chosen before: PS\_AC\_Period and PS\_AC\_Num. Possible periodes are much more fast as the ones for normal proximity measurements, just between 3 ms and 24 ms. The auto calibration is then done when PS\_AC\_TRIG is set. Whole procedure is shown within Fig. 39.

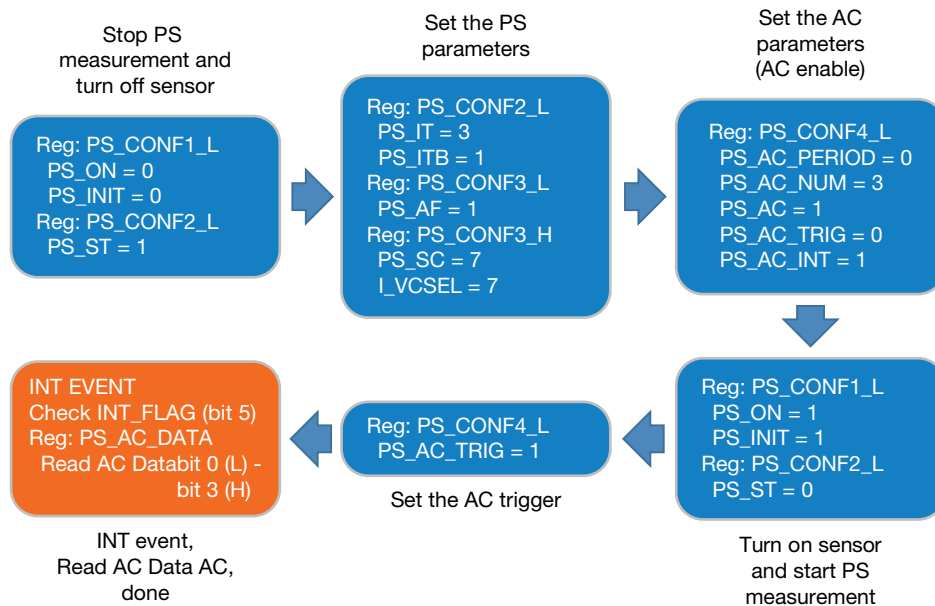

Fig. 39 - Software Flow Chart (for auto / dynamic calibration)



The DNA of tech.®

## Designing the VCNL36826S Into an Application

REGISTER: PS_CONF2_L		Command Code: 0x03_L (0x03 Data Byte Low)
COMMAND	BIT	Description
PS_Period	7 : 6	(0 : 0) = 10 ms, (0 : 1) = 20 ms, (1 : 0) = 40 ms, (1 : 1) = 80 ms PS sample period setting

REGISTER: PS_CONF2_H		Command Code: 0x03_H (0x03 Data Byte High)
COMMAND	BIT	Description
PS_IT	7 : 6	(0 : 0) = 1T, (0 : 1) = 2T, (1 : 0) = 4T, (1 : 1) = 8T
PS_MPS	5 : 4	(0 : 0) = 1, (0 : 1) = 2, (1 : 0) = 4, (1 : 1) = 8 PS multi-pulse setting
Reserved	3	Must be set to "1" when power on ready
PS_HG	2	0 = disable, 1 = enable, PS high gain mode
Reserved	1 : 0	Default = (0 : 0)

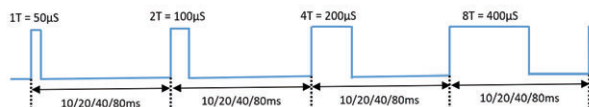

Fig. 40 - Normal PS Operation Setting

REGISTER: PS_CONF4_L		Command Code: 0x08_L (0x08 Data Byte Low)
COMMAND	BIT	Description
PS_AC_PERIOD	7 : 6	(0 : 0) = 3 ms, (0 : 1) = 6 ms, (1 : 0) = 12 ms, (1 : 1) = 24 ms PS auto-calibration detect sample period setting
PS_AC_NUM	5 : 4	(0 : 0) = 1, (0 : 1) = 2, (1 : 0) = 4, (1 : 1) = 8 PS auto-calibration detect sample number setting
PS_AC	3	0 = disable; 1 = enable PS auto-calibration enable; need set PS_AF = 1
PS_AC_TRIG	2	0 = disable; 1 = enable Trigger one time auto-calibration
Reserved	1	Reserved
PS_AC_INT	0	0 = disable; 1 = enable PS auto-calibration INT setting

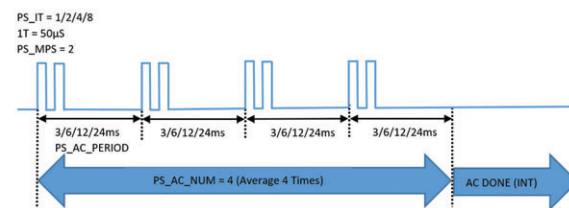

Fig. 41 - PS Auto Calibration Setting

REGISTER: PS_CONF4_L DESCRIPTION		
COMMAND CODE: 0x08_L (0x08 DATA BYTE LOW)		
Register	Bit	Description
PS_AC_PERIOD	7 : 6	(0 : 0) = 3 ms, (0 : 1) = 6 ms, (1 : 0) = 12 ms, (1 : 1) = 24 ms; PS auto-calibration detect sample period setting
PS_AC_NUM	5 : 4	(0 : 0) = 1, (0 : 1) = 2, (1 : 0) = 4, (1 : 1) = 8; PS auto-calibration detect sample number setting
PS_AC	3	0 = disable, 1 = enable; PS auto-calibration enable; need set PS_AF = 1
PS_AC_TRIG	2	0 = disable, 1 = enable; trigger one time auto-calibration
Reserved	1	Reserved
PS_AC_INT	0	0 = disable, 1 = enable; PS auto-calibration INT setting



The DNA of tech.®

## Designing the VCNL36826S Into an Application

READ OUT REGISTER DESCRIPTION			
Register	Command Code	Bit	Description
PS_Data_L	0xF8_L (0xF8 data byte low)	7 : 0	0x00 to 0xFF, PS output data
PS_Data_H	0xF8_H (0xF8 data byte high)	3 : 0	0x00 to 0x0F, PS output data
INT_Flag	0xF9_H (0xF9 data byte high)	7 : 6 5 4 3 2 1 0	Reserved PS_ACFLAG, after PS finishing auto-calibration, INT raise PS_SPFLAG, PS entering protection mode Reserved Reserved PS_IF_CLOSE, PS rises above PS_THDH INT trigger event PS_IF_AWAY, PS drops below PS_THDL INT trigger event
ID_L	0xFA_L (0xFA data byte low)	7 : 0	Default = 0010 0110, device ID LSB byte
ID_H	0xFA_H (0xFA data byte high)	7 : 6 5 : 4 3 : 0	(0 : 0) (0 : 0) slave address = 0x60 Version code (0 : 0 : 0 : 0) device ID MSB byte
PS_AC_Data_L	0xFB_L (0xFB data byte low)	7 : 0	0x00 to 0xFF, PS auto-calibration data (LSB)
PS_AC_Data_H	0xFB_H (0xFB data byte high)	7 6 5 : 4 3 : 0	AC_BUSY, when AC, the bit will be "1" AC_SUN, PS enters sunlight protect during auto-calibration Reserved 0x00 to 0xFF, PS auto-calibration data (MSB)