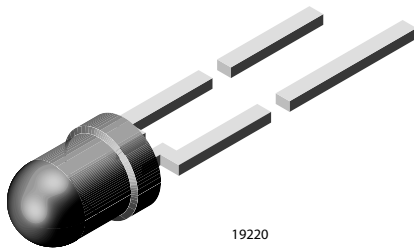


## High Efficiency LED in Ø 3 mm Tinted Diffused Package



### DESCRIPTION

The TLHG44K1L2 was developed for standard applications like general indicating and lighting purposes.

It is housed in a 3 mm tinted diffused plastic package. The wide viewing angle of these devices provides a high brightness across a large field of view.

All LEDs are categorized in luminous intensity groups. The color is categorized additionally in wavelength groups.

That allows users to assemble LEDs with uniform appearance.

### PRODUCT GROUP AND PACKAGE DATA

- Product group: LED
- Package: 3 mm
- Product series: standard
- Angle of half intensity:  $\pm 30^\circ$

### FEATURES

- Standard Ø 3 (T-1) package
- Small mechanical tolerances
- Suitable for DC and high peak current
- Wide viewing angle
- Luminous intensity categorized
- Color categorized
- Material categorization:  
for definitions of compliance please see [www.vishay.com/doc?99912](http://www.vishay.com/doc?99912)



### APPLICATIONS

- Status lights
- Off / on indicator
- Background illumination
- Readout lights
- Maintenance lights
- Legend light

### PARTS TABLE

PART	COLOR	LUMINOUS INTENSITY (mcd)			at I <sub>F</sub> (mA)	WAVELENGTH (nm)			at I <sub>F</sub> (mA)	FORWARD VOLTAGE (V)			at I <sub>F</sub> (mA)	TECHNOLOGY
		MIN.	TYP.	MAX.		MIN.	TYP.	MAX.		MIN.	TYP.	MAX.		
TLHG44K1L2	Green	7.1	-	18	10	562	-	575	10	-	2.1	2.6	10	GaP on GaP

### ABSOLUTE MAXIMUM RATINGS (T<sub>amb</sub> = 25 °C, unless otherwise specified)

#### TLHG44K1L2

PARAMETER	TEST CONDITION	SYMBOL	VALUE	UNIT
Reverse voltage		V <sub>R</sub>	6	V
DC forward current		I <sub>F</sub>	30	mA
Surge forward current	t <sub>p</sub> ≤ 10 μs	I <sub>FSM</sub>	1	A
Power dissipation	T <sub>amb</sub> ≤ 60 °C	P <sub>V</sub>	100	mW
Junction temperature		T <sub>j</sub>	100	°C
Operating temperature range		T <sub>amb</sub>	-40 to +100	°C
Storage temperature range		T <sub>stg</sub>	-55 to +100	°C
Soldering temperature	t ≤ 5 s, 2 mm from body	T <sub>sd</sub>	260	°C
Thermal resistance junction/ambient		R <sub>thJA</sub>	400	K/W

**OPTICAL AND ELECTRICAL CHARACTERISTICS** ( $T_{amb} = 25\text{ }^{\circ}\text{C}$ , unless otherwise specified)  
**TLHG44K1L2, GREEN**

PARAMETER	TEST CONDITION	PART	SYMBOL	MIN.	TYP.	MAX.	UNIT
Luminous intensity <sup>(1)</sup>	$I_F = 10\text{ mA}$	TLHG44K1L2	$I_V$	7.1	-	18	mcd
Dominant wavelength	$I_F = 10\text{ mA}$		$\lambda_d$	562	-	575	nm
Peak wavelength	$I_F = 10\text{ mA}$		$\lambda_p$	-	565	-	nm
Angle of half intensity	$I_F = 10\text{ mA}$		$\phi$	-	$\pm 30$	-	deg
Forward voltage	$I_F = 10\text{ mA}$		$V_F$	-	2.1	2.6	V
Reverse voltage	$I_R = 10\text{ }\mu\text{A}$		$V_R$	6	15	-	V
Junction capacitance	$V_R = 0\text{ V}, f = 1\text{ MHz}$		$C_j$	-	50	-	pF

**Note**

(1) in one packing unit  $i_{vmin}/i_{vmax} \leq 1.6$

**LUMINOUS INTENSITY CLASSIFICATION**

GROUP	LIGHT INTENSITY (mcd)			
	STANDARD	OPTIONAL	MIN.	MAX.
K	1	7.1	9	
	2	9	11.2	
L	1	11.2	14.0	
	2	14.0	18.0	

**Note**

- Luminous intensity is tested at a current pulse duration of 25 ms and an accuracy of  $\pm 11\%$ . The above type numbers represent the order groups which include only a few brightness groups. Only one group will be shipped on each reel (there will be no mixing of two groups on each reel). In order to ensure availability, single brightness groups will not be orderable. In a similar manner for colors where wavelength groups are measured and binned, single wavelength groups will be shipped on any one reel. In order to ensure availability, single wavelength groups will not be orderable.

**COLOR CLASSIFICATION**

GROUP	GREEN	
	DOM. WAVELENGTH (nm)	
	MIN.	MAX.
3	562	565
4	564	567
5	566	569
6	568	571
7	570	573
8	572	575

**Note**

- Wavelengths are tested at a current pulse duration of 25 ms.

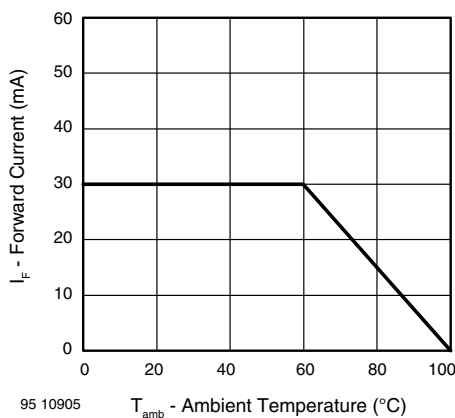
**TYPICAL CHARACTERISTICS** ( $T_{amb} = 25\text{ }^{\circ}\text{C}$ , unless otherwise specified)


Fig. 1 - Forward Current vs. Ambient Temperature for InGaN

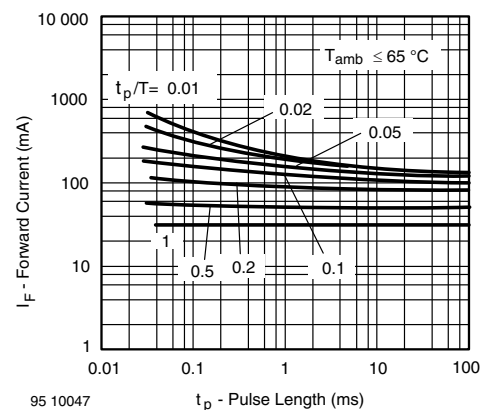


Fig. 2 - Forward Current vs. Pulse Length

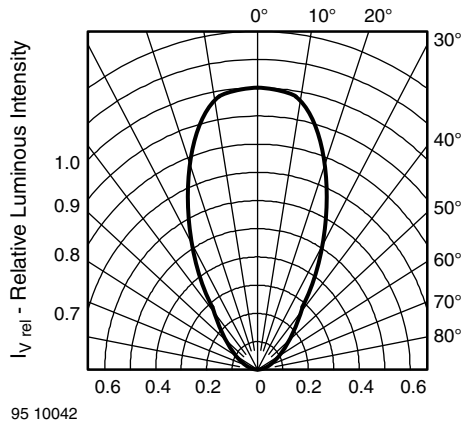


Fig. 3 - Relative Luminous Intensity vs. Angular Displacement

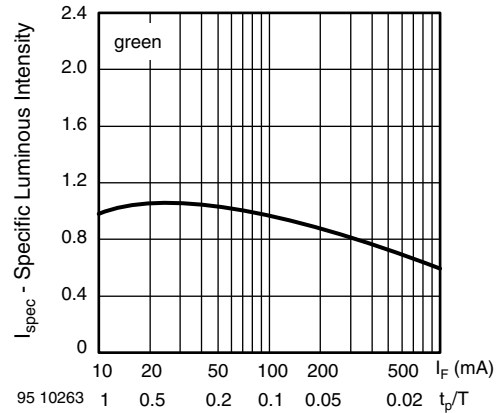


Fig. 6 - Specific Luminous Intensity vs. Forward Current

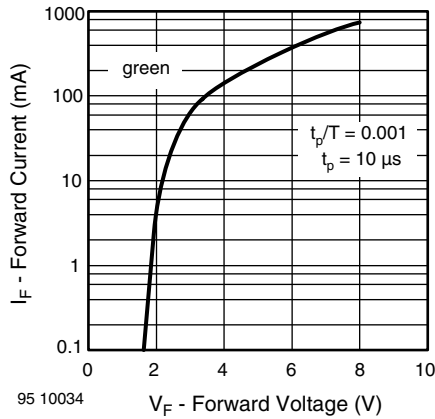


Fig. 4 - Forward Current vs. Forward Voltage

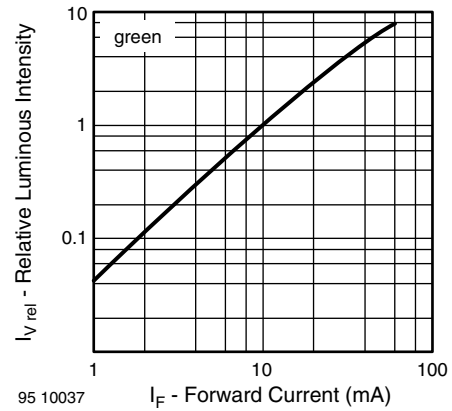


Fig. 7 - Relative Luminous Intensity vs. Forward Current

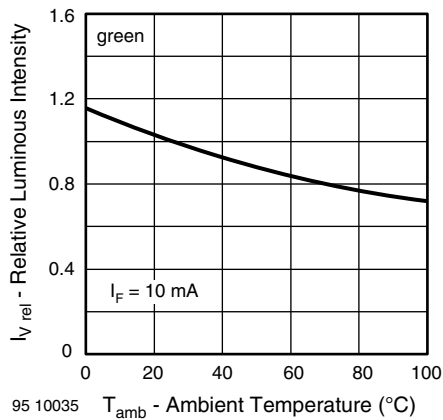


Fig. 5 - Relative Luminous Intensity vs. Ambient Temperature

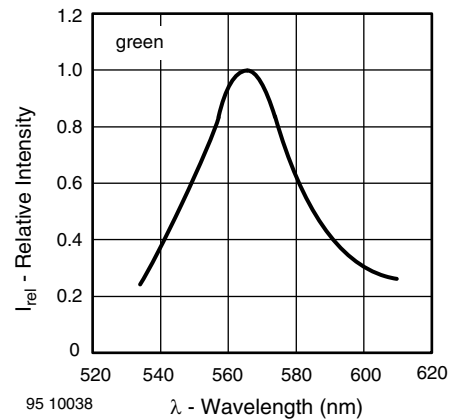
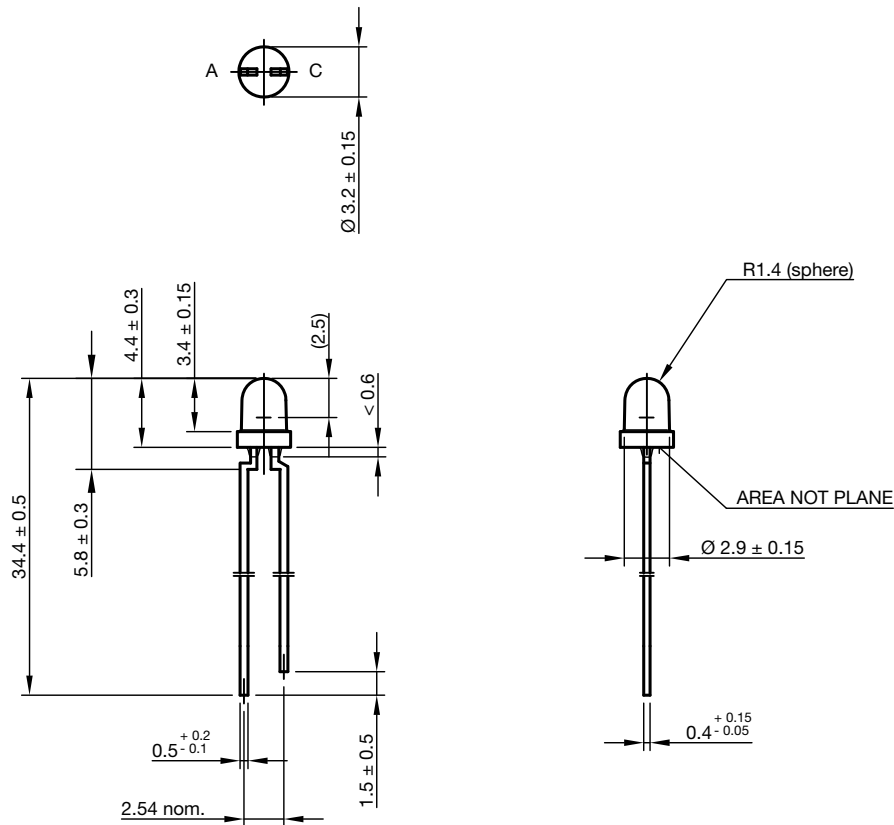
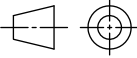


Fig. 8 - Relative Intensity vs. Wavelength



## PACKAGE DIMENSIONS in millimeters



  
technical drawings  
according to DIN  
specifications

Drawing-No.: 6.544-5255.01-4  
Issue: 9; 28.07.14



## Disclaimer

ALL PRODUCT, PRODUCT SPECIFICATIONS AND DATA ARE SUBJECT TO CHANGE WITHOUT NOTICE TO IMPROVE RELIABILITY, FUNCTION OR DESIGN OR OTHERWISE.

Vishay Intertechnology, Inc., its affiliates, agents, and employees, and all persons acting on its or their behalf (collectively, "Vishay"), disclaim any and all liability for any errors, inaccuracies or incompleteness contained in any datasheet or in any other disclosure relating to any product.

Vishay makes no warranty, representation or guarantee regarding the suitability of the products for any particular purpose or the continuing production of any product. To the maximum extent permitted by applicable law, Vishay disclaims (i) any and all liability arising out of the application or use of any product, (ii) any and all liability, including without limitation special, consequential or incidental damages, and (iii) any and all implied warranties, including warranties of fitness for particular purpose, non-infringement and merchantability.

Statements regarding the suitability of products for certain types of applications are based on Vishay's knowledge of typical requirements that are often placed on Vishay products in generic applications. Such statements are not binding statements about the suitability of products for a particular application. It is the customer's responsibility to validate that a particular product with the properties described in the product specification is suitable for use in a particular application. Parameters provided in datasheets and / or specifications may vary in different applications and performance may vary over time. All operating parameters, including typical parameters, must be validated for each customer application by the customer's technical experts. Product specifications do not expand or otherwise modify Vishay's terms and conditions of purchase, including but not limited to the warranty expressed therein.

Hyperlinks included in this datasheet may direct users to third-party websites. These links are provided as a convenience and for informational purposes only. Inclusion of these hyperlinks does not constitute an endorsement or an approval by Vishay of any of the products, services or opinions of the corporation, organization or individual associated with the third-party website. Vishay disclaims any and all liability and bears no responsibility for the accuracy, legality or content of the third-party website or for that of subsequent links.

Except as expressly indicated in writing, Vishay products are not designed for use in medical, life-saving, or life-sustaining applications or for any other application in which the failure of the Vishay product could result in personal injury or death. Customers using or selling Vishay products not expressly indicated for use in such applications do so at their own risk. Please contact authorized Vishay personnel to obtain written terms and conditions regarding products designed for such applications.

No license, express or implied, by estoppel or otherwise, to any intellectual property rights is granted by this document or by any conduct of Vishay. Product names and markings noted herein may be trademarks of their respective owners.