



IR Receiver Modules for Remote Control Systems



22531

DESCRIPTION

The TSSP570.. is a compact infrared detector module for presence sensing applications. It receives 38 kHz modulated signals and has a peak sensitivity of 940 nm. This component has not been qualified according to automotive specifications.

FEATURES

- Presence sensor: up to 2 m distance, find more info at: www.vishay.com/doc?49009
- Light barrier: up to 12 m distance, TSAL6200 with $I_F = 50$ mA, find more info at: www.vishay.com/doc?49650
- Fast proximity: up to 2 m range at 5 ms response time, find more info at: www.vishay.com/doc?82741
- Supply voltage: 2.0 V to 5.5 V
- Material categorization: for definitions of compliance please see www.vishay.com/doc?99912



RoHS
COMPLIANT
HALOGEN
FREE
GREEN
(5-2008)

LINKS TO ADDITIONAL RESOURCES



APPLICATIONS

- Reflective sensors for hand dryers, towel or soap dispensers, water faucets, toilet flush
- Vending machine fall detection
- Security and pet gates
- Person or object vicinity switch
- Fast proximity sensors for toys, robotics, drones, and other consumer and industrial uses

DESIGN SUPPORT TOOLS

- [3D models](#)
- [Window size calculator](#)

BLOCK DIAGRAM

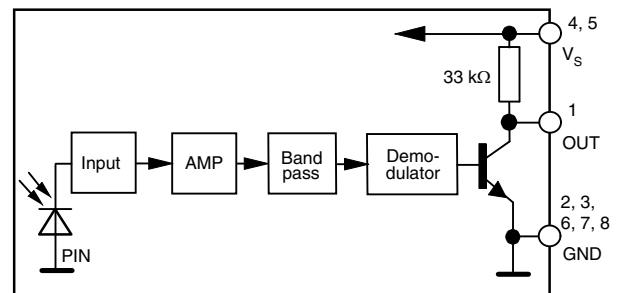

20445-7



MECHANICAL DATA

Pinning:

1 = OUT, 2, 3, 6, 7, 8 = GND, 4, 5 = V_S

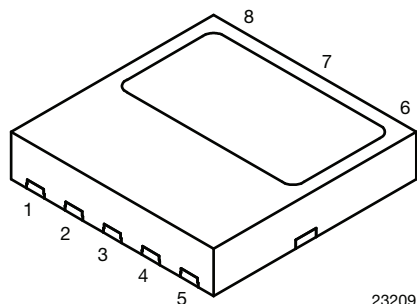

ORDERING CODE

Taping:

TSSP570..TT1 - top view taped, 1800 pcs/reel

PRESENCE SENSING

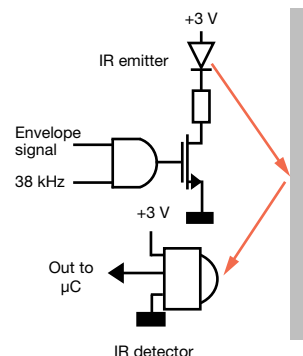

PARTS TABLE			
Carrier frequency	38 kHz		TSSP57038
	56 kHz		TSSP57056
Package			Belobog
Pinning			1, 4 = GND, 2 = V _S , 3 = OUT
Dimensions (mm)			3.95 W x 3.95 H x 0.8 D
Mounting			SMD
Application			Presence sensors, fast proximity sensors
Special options			• Extended temperature range: www.vishay.com/doc?82738

ABSOLUTE MAXIMUM RATINGS				
PARAMETER	TEST CONDITION	SYMBOL	VALUE	UNIT
Supply voltage		V _S	-0.3 to +6	V
Supply current		I _S	5	mA
Output voltage		V _O	-0.3 to (V _S + 0.3)	V
Output current		I _O	5	mA
Junction temperature		T _j	100	°C
Storage temperature range		T _{stg}	-25 to +85	°C
Operating temperature range		T _{amb}	-25 to +85	°C
Power consumption	T _{amb} ≤ 85 °C	P _{tot}	10	mW

Note

- Stresses beyond those listed under “Absolute Maximum Ratings” may cause permanent damage to the device. This is a stress rating only and functional operation of the device at these or any other conditions beyond those indicated in the operational sections of this specification is not implied. Exposure to absolute maximum rating conditions for extended periods may affect the device reliability



ELECTRICAL AND OPTICAL CHARACTERISTICS ($T_{amb} = 25\text{ }^{\circ}\text{C}$, unless otherwise specified)						
PARAMETER	TEST CONDITION	SYMBOL	MIN.	TYP.	MAX.	UNIT
Supply current (pin 3)	$E_v = 0, V_S = 3.3\text{ V}$	I_{SD}	0.25	0.35	0.45	mA
	$E_v = 40\text{ klx, sunlight}$	I_{SH}	-	0.45	-	mA
Supply voltage		V_S	2.0	-	5.5	V
Transmission distance	$E_v = 0$, test signal see Fig. 1, IR diode TSAL6200, $I_F = 50\text{ mA}$	d	-	8	-	m
Output voltage low (pin 1)	$I_{OSL} = 0.5\text{ mA}$, $E_e = 2\text{ mW/m}^2$, test signal see Fig. 1	V_{OSL}	-	-	100	mV
Minimum irradiance	Pulse width tolerance: $t_{pi} - 4/f_0 < t_{po} < t_{pi} + 4/f_0$, test signal see Fig. 1	$E_{e\text{ min.}}$	-	0.7	1.2	mW/m^2
Maximum irradiance	Pulse width tolerance: $t_{pi} - 4/f_0 < t_{po} < t_{pi} + 4/f_0$, test signal see Fig. 1	$E_{e\text{ max.}}$	30	-	-	W/m^2
Directivity	Angle of half transmission distance	$\varphi_{1/2}$	-	± 75	-	$^{\circ}$

TYPICAL CHARACTERISTICS ($T_{amb} = 25\text{ }^{\circ}\text{C}$, unless otherwise specified)

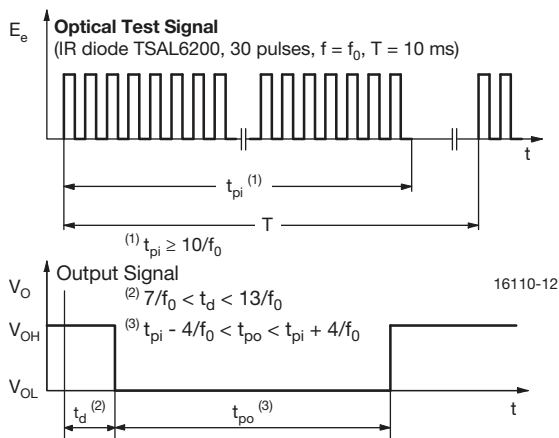

Fig. 1 - Output Active Low

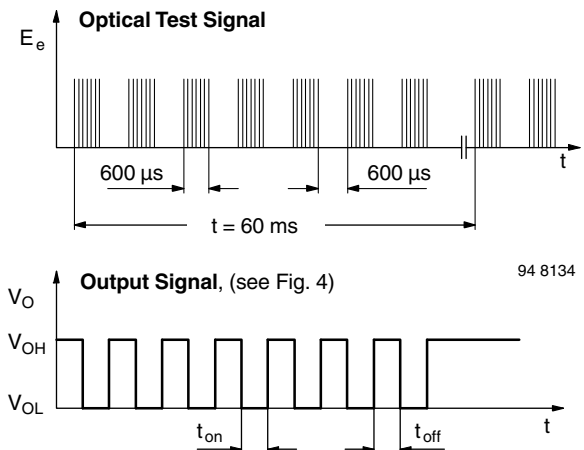

Fig. 3 - Output Function

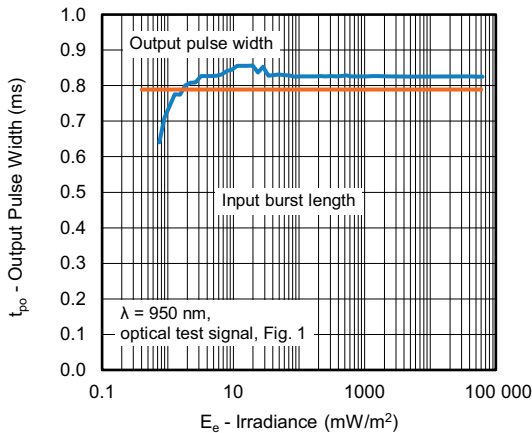

Fig. 2 - Pulse Length and Sensitivity in Dark Ambient

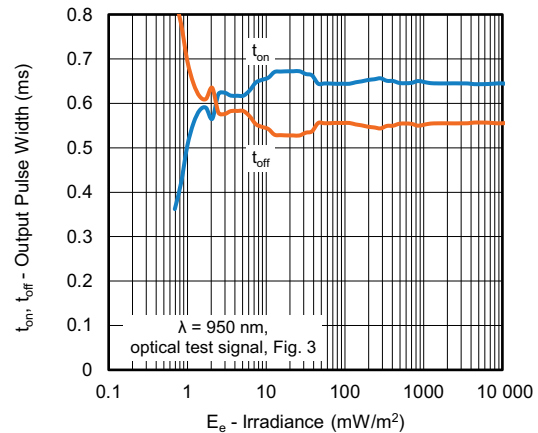

Fig. 4 - Output Pulse Diagram

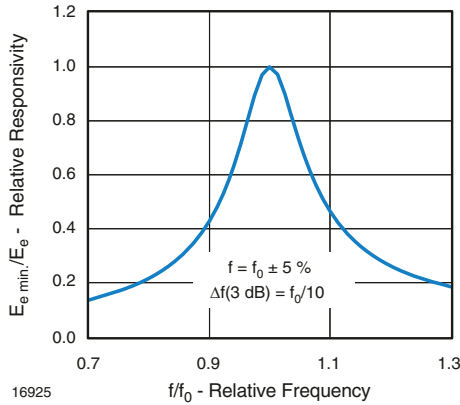

Fig. 5 - Frequency Dependence of Responsivity

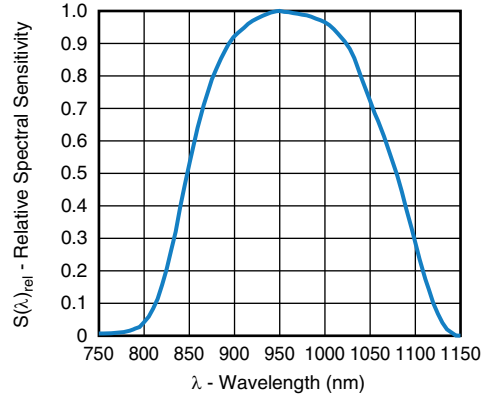

Fig. 8 - Relative Spectral Sensitivity vs. Wavelength

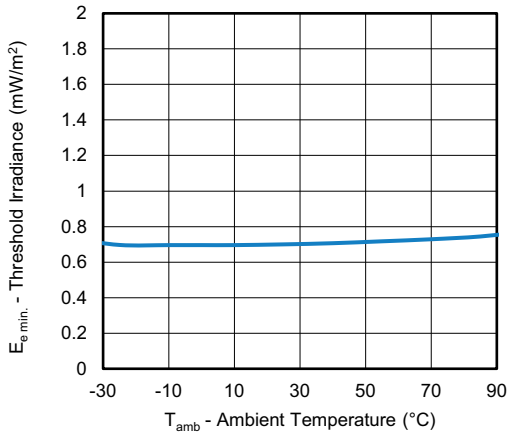

Fig. 6 - Sensitivity vs. Ambient Temperature

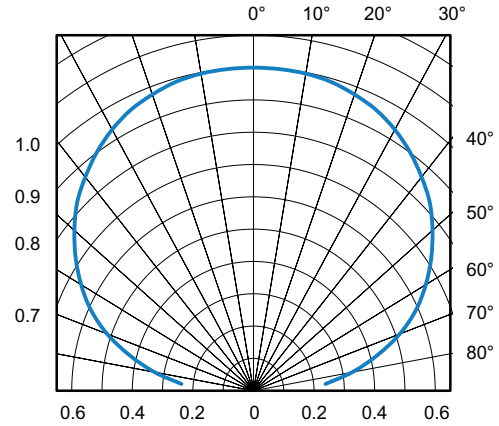

Fig. 9 - Horizontal Directivity

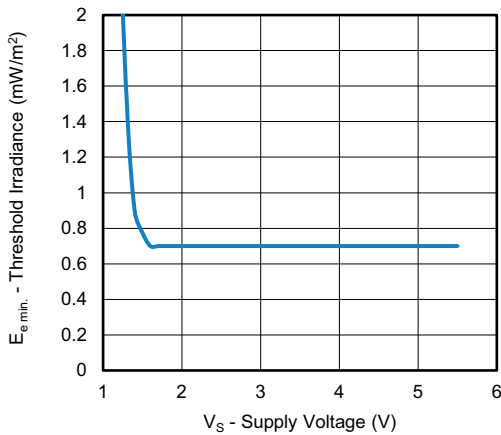
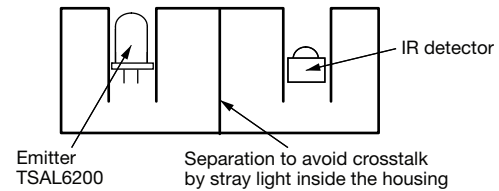

Fig. 7 - Sensitivity vs. Supply Voltage

The typical application of this device is a reflective or beam break sensor with active low “detect” or “no detect” information contained in its output. The TSSP570.. is also suitable for fast (~ 15 ms) proximity sensor applications for ranges between 10 cm and 2 m, if a burst pattern with variable intensity is used.

Example for a sensor hardware:



There should be no common window in front of the emitter and detector in order to avoid crosstalk via guided light through the window.



PACKAGE DIMENSIONS in millimeters

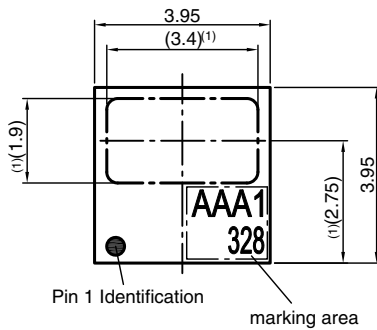
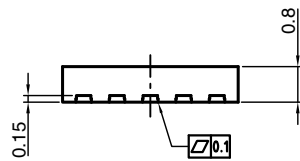
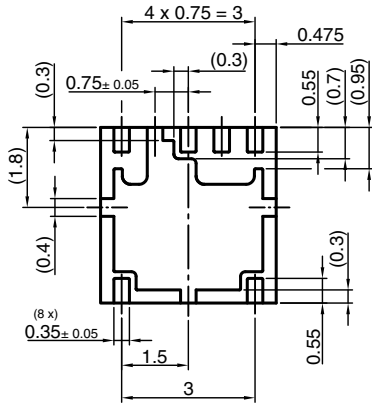

Drawing-No.: 6.550-5315.01-4
Issue: 2; 12.02.14

Notes

- (1) Optically effective area
- (2) Pins connected internally. It is not necessary to connect externally

Not indicated tolerances ± 0.1



Pinning from topview

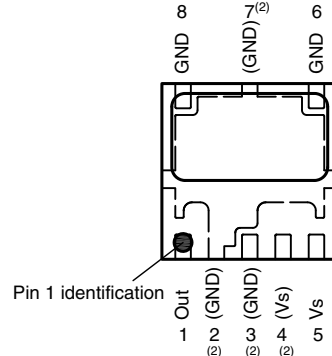

Proposed pad layout from component side (dim. for reference only)

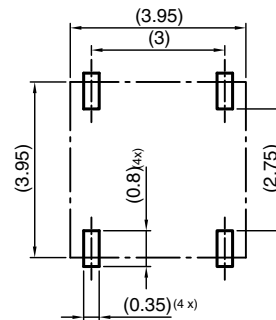



ASSEMBLY INSTRUCTIONS

Reflow Soldering

- Reflow soldering must be done within 168 h while stored under a max. temperature of 30 °C, 60 % RH after opening the dry pack envelope
- Set the furnace temperatures for pre-heating and heating in accordance with the reflow temperature profile as shown in the diagram. Exercise extreme care to keep the maximum temperature below 260 °C. The temperature shown in the profile means the temperature at the device surface. Since there is a temperature difference between the component and the circuit board, it should be verified that the temperature of the device is accurately being measured
- Handling after reflow should be done only after the work surface has been cooled off

Manual Soldering

- Use a soldering iron of 25 W or less. Adjust the temperature of the soldering iron below 300 °C
- Finish soldering within 3 s
- Handle products only after the temperature has cooled off

VISHAY LEAD (Pb)-FREE REFLOW SOLDER PROFILE

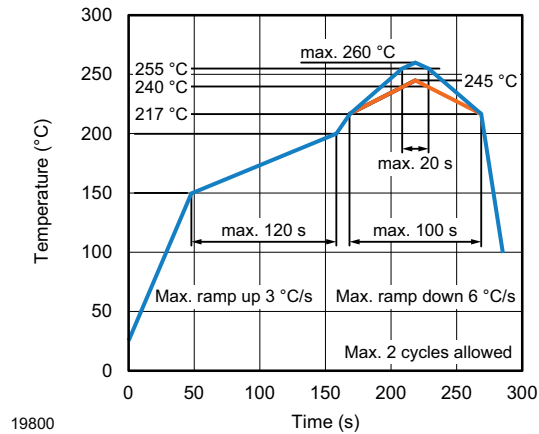



TAPING VERSION TSSP57038 DIMENSIONS in millimeters

Tape and reel dimensions:

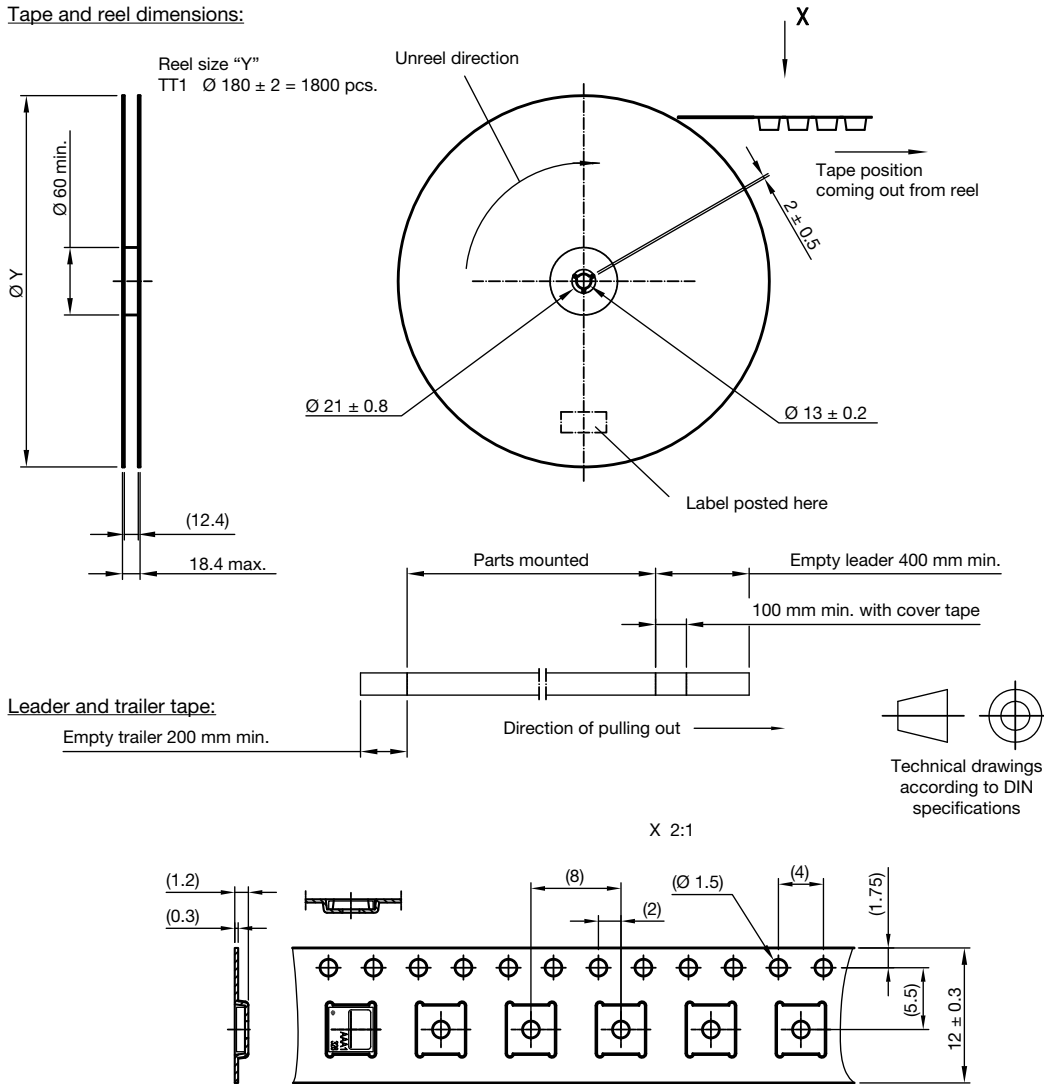

Drawing-No.: 9.700-5347.01-4
Issue: 2; 07.03.18

Not indicated tolerances ± 0.1



OUTER PACKAGING

The sealed reel is packed into a pizza box.

CARTON BOX DIMENSIONS in millimeters			
	THICKNESS	WIDTH	LENGTH
Pizza box (Panhead, Heimdall, and Belobog) (taping in reels)	50	340	340

LABEL

Standard bar code labels for finished goods

The standard bar code labels are product labels and used for identification of goods. The finished goods are packed in final packing area. The standard packing units are labeled with standard bar code labels before transported as finished goods to warehouses. The labels are on each packing unit and contain Vishay Semiconductor GmbH specific data.

VISHAY SEMICONDUCTOR GmbH STANDARD BAR CODE PRODUCT LABEL (finished goods)		
PLAIN WRITING	ABBREVIATION	LENGTH
Item-description	-	18
Item-number	INO	8
Selection-code	SEL	3
LOT-/serial-number	BATCH	10
Data-code	COD	3 (YWW)
Plant-code	PTC	2
Quantity	QTY	8
Accepted by	ACC	-
Packed by	PCK	-
Mixed code indicator	MIXED CODE	-
Origin	xxxxxxx+	Company logo
LONG BAR CODE TOP	TYPE	LENGTH
Item-number	N	8
Plant-code	N	2
Sequence-number	X	3
Quantity	N	8
Total length	-	21
SHORT BAR CODE BOTTOM	TYPE	LENGTH
Selection-code	X	3
Data-code	N	3
Batch-number	X	10
Filter	-	1
Total length	-	17



DRY PACKING

The reel is packed in an anti-humidity bag to protect the devices from absorbing moisture during transportation and storage.

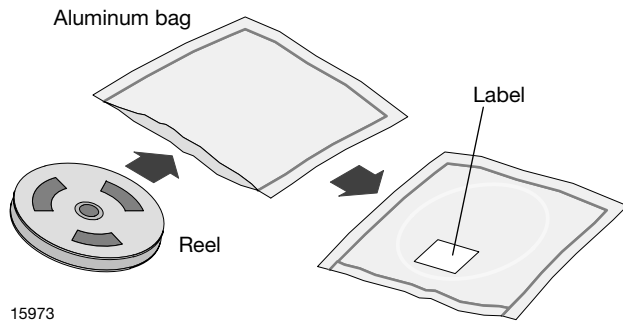

15973

FINAL PACKING

The sealed reel is packed into a cardboard box.

RECOMMENDED METHOD OF STORAGE

Dry box storage is recommended as soon as the aluminum bag has been opened to prevent moisture absorption. The following conditions should be observed, if dry boxes are not available:

- Storage temperature 10 °C to 30 °C
- Storage humidity ≤ 60 % RH max.

After more than 168 h under these conditions moisture content will be too high for reflow soldering.

In case of moisture absorption, the devices will recover to the former condition by drying under the following condition:
 192 h at 40 °C + 5 °C / - 0 °C and < 5 % RH (dry air / nitrogen) or
 96 h at 60 °C + 5 °C and < 5 % RH for all device containers or
 24 h at 125 °C + 5 °C not suitable for reel or tubes.

An EIA JEDEC® standard J-STD-020 level 3 label is included on all dry bags.

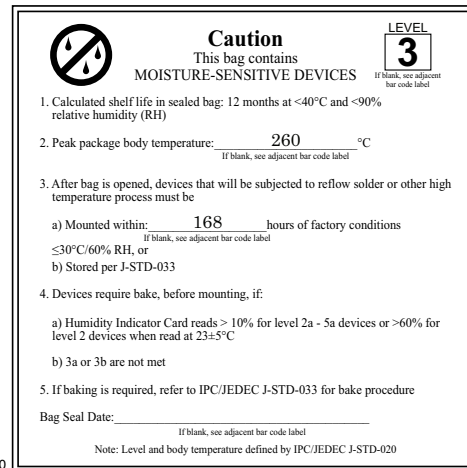

22650

EIA JEDEC standard J-STD-020 level 3 label is included on all dry bags

ESD PRECAUTION

Proper storage and handling procedures should be followed to prevent ESD damage to the devices especially when they are removed from the antistatic shielding bag. Electrostatic sensitive devices warning labels are on the packaging.

VISHAY SEMICONDUCTORS STANDARD BAR CODE LABELS

The Vishay Semiconductors standard bar code labels are printed at final packing areas. The labels are on each packing unit and contain Vishay Semiconductors specific data.

BAR CODE PRODUCT LABEL (example)

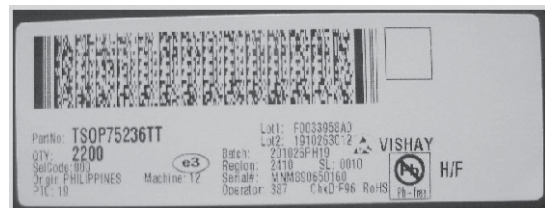

22178



Disclaimer

ALL PRODUCT, PRODUCT SPECIFICATIONS AND DATA ARE SUBJECT TO CHANGE WITHOUT NOTICE TO IMPROVE RELIABILITY, FUNCTION OR DESIGN OR OTHERWISE.

Vishay Intertechnology, Inc., its affiliates, agents, and employees, and all persons acting on its or their behalf (collectively, "Vishay"), disclaim any and all liability for any errors, inaccuracies or incompleteness contained in any datasheet or in any other disclosure relating to any product.

Vishay makes no warranty, representation or guarantee regarding the suitability of the products for any particular purpose or the continuing production of any product. To the maximum extent permitted by applicable law, Vishay disclaims (i) any and all liability arising out of the application or use of any product, (ii) any and all liability, including without limitation special, consequential or incidental damages, and (iii) any and all implied warranties, including warranties of fitness for particular purpose, non-infringement and merchantability.

Statements regarding the suitability of products for certain types of applications are based on Vishay's knowledge of typical requirements that are often placed on Vishay products in generic applications. Such statements are not binding statements about the suitability of products for a particular application. It is the customer's responsibility to validate that a particular product with the properties described in the product specification is suitable for use in a particular application. Parameters provided in datasheets and / or specifications may vary in different applications and performance may vary over time. All operating parameters, including typical parameters, must be validated for each customer application by the customer's technical experts. Product specifications do not expand or otherwise modify Vishay's terms and conditions of purchase, including but not limited to the warranty expressed therein.

Hyperlinks included in this datasheet may direct users to third-party websites. These links are provided as a convenience and for informational purposes only. Inclusion of these hyperlinks does not constitute an endorsement or an approval by Vishay of any of the products, services or opinions of the corporation, organization or individual associated with the third-party website. Vishay disclaims any and all liability and bears no responsibility for the accuracy, legality or content of the third-party website or for that of subsequent links.

Except as expressly indicated in writing, Vishay products are not designed for use in medical, life-saving, or life-sustaining applications or for any other application in which the failure of the Vishay product could result in personal injury or death. Customers using or selling Vishay products not expressly indicated for use in such applications do so at their own risk. Please contact authorized Vishay personnel to obtain written terms and conditions regarding products designed for such applications.

No license, express or implied, by estoppel or otherwise, to any intellectual property rights is granted by this document or by any conduct of Vishay. Product names and markings noted herein may be trademarks of their respective owners.