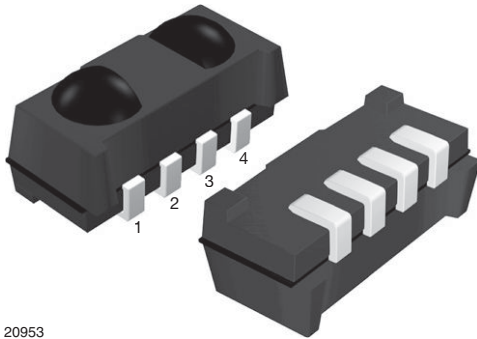


## IR Receiver Modules for Remote Control Systems



20953

### DESIGN SUPPORT TOOLS

[click logo to get started](#)


### MECHANICAL DATA

#### Pinning:

 1, 4 = GND, 2 =  $V_S$ , 3 = OUT

### ORDERING CODE

#### Taping:

TSOP75...TT - top view taped

TSOP75...TR - side view taped

### FEATURES

- Very low supply current
- Photo detector and preamplifier in one package
- Compatible also with short burst dataformats
- Supply voltage: 2.5 V to 5.5 V
- Improved immunity against ambient light
- Capable of side or top view
- Two lenses for high sensitivity and wide receiving angle
- Insensitive to supply voltage ripple and noise
- Material categorization: for definitions of compliance please see [www.vishay.com/doc?99912](http://www.vishay.com/doc?99912)


**RoHS**  
 COMPLIANT  
 HALOGEN  
**FREE**  
**GREEN**  
(5-2008)

### DESCRIPTION

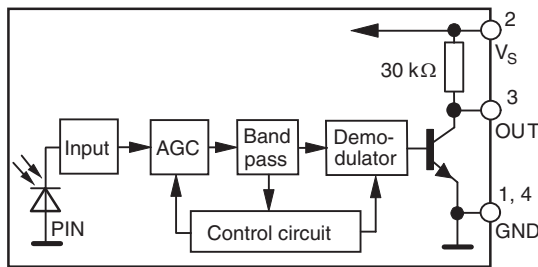
The TSOP753.., TSOP755.. series are a two lens miniaturized receiver module for infrared remote control systems. One PIN diode per lens and a preamplifier are assembled on a leadframe, the epoxy lens cap contains an IR filter.

The TSOP753..series is optimized to suppress almost all spurious pulses from energy saving lamps like CFLs. AGC3 may also suppress some data signals if continuously transmitted.

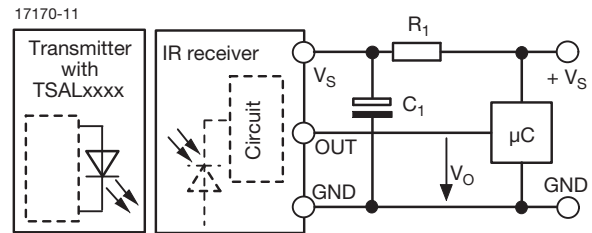
The TSOP755.. series contain a very robust AGC5. This series should only be used for critically noisy environments.

This component has not been qualified according to automotive specifications.

PARTS TABLE		
AGC	NOISY ENVIRONMENTS AND SHORT BURSTS (AGC3)	VERY NOISY ENVIRONMENTS AND SHORT BURSTS (AGC5)
Carrier frequency	30 kHz	TSOP75330
	33 kHz	TSOP75333
	36 kHz	TSOP75336 <sup>(1)</sup>
	38 kHz	TSOP75338 <sup>(2)(3)(4)(5)</sup>
	40 kHz	TSOP75340
	56 kHz	TSOP75356
Package	Heimdall	
Pinning	1, 4 = GND, 2 = $V_S$ , 3 = OUT	
Dimensions (mm)	6.8 W x 3.0 H x 3.2 D	
Mounting	SMD	
Application	Remote control	
Best choice for	<sup>(1)</sup> MCIR <sup>(2)</sup> Mitsubishi <sup>(3)</sup> RECS-80 Code <sup>(4)</sup> r-map <sup>(5)</sup> XMP-1, XMP-2	

**BLOCK DIAGRAM**


20445-1

**APPLICATION CIRCUIT**

 $R_1$  and  $C_1$  recommended to reduce supply ripple for  $V_S < 2.8$  V

**ABSOLUTE MAXIMUM RATINGS**

PARAMETER	TEST CONDITION	SYMBOL	VALUE	UNIT
Supply voltage		$V_S$	-0.3 to +6	V
Supply current		$I_S$	3	mA
Output voltage		$V_O$	-0.3 to ( $V_S + 0.3$ )	V
Output current		$I_O$	5	mA
Junction temperature		$T_j$	100	°C
Storage temperature range		$T_{stg}$	-25 to +85	°C
Operating temperature range		$T_{amb}$	-25 to +85	°C
Power consumption	$T_{amb} \leq 85$ °C	$P_{tot}$	10	mW

**Note**

- Stresses beyond those listed under "Absolute Maximum Ratings" may cause permanent damage to the device. This is a stress rating only and functional operation of the device at these or any other conditions beyond those indicated in the operational sections of this specification is not implied. Exposure to absolute maximum rating conditions for extended periods may affect the device reliability

**ELECTRICAL AND OPTICAL CHARACTERISTICS** ( $T_{amb} = 25$  °C, unless otherwise specified)

PARAMETER	TEST CONDITION	SYMBOL	MIN.	TYP.	MAX.	UNIT
Supply voltage		$V_S$	2.5	-	5.5	V
Supply current	$E_v = 0, V_S = 3.3$ V	$I_{SD}$	0.27	0.35	0.45	mA
	$E_v = 40$ klx, sunlight	$I_{SH}$	-	0.45	-	mA
Transmission distance	$E_v = 0$ , test signal see Fig. 1, IR diode TSAL6200, $I_F = 50$ mA	$d$	-	24	-	m
Output voltage low	$I_{OSL} = 0.5$ mA, $E_e = 0.7$ mW/m <sup>2</sup> , test signal see Fig. 1	$V_{OSL}$	-	-	100	mV
Minimum irradiance	Pulse width tolerance: $t_{pi} - 5/f_0 < t_{po} < t_{pi} + 6/f_0$ , test signal see Fig. 1	$E_e$ min.	-	0.12	0.25	mW/m <sup>2</sup>
Maximum irradiance	$t_{pi} - 5/f_0 < t_{po} < t_{pi} + 6/f_0$ , test signal see Fig. 1	$E_e$ max.	30	-	-	W/m <sup>2</sup>
Directivity	Angle of half transmission distance	$\phi_{1/2}$	-	$\pm 50$	-	deg

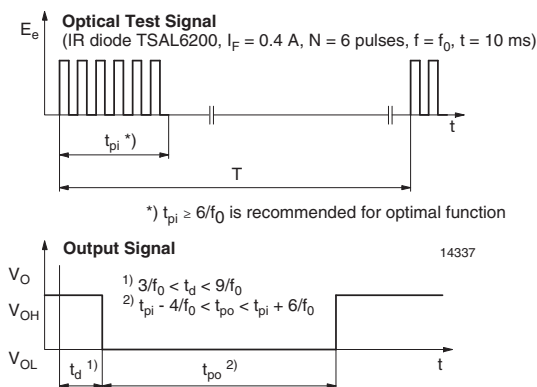
**TYPICAL CHARACTERISTICS** ( $T_{amb} = 25$  °C, unless otherwise specified)


Fig. 1 - Output Active Low

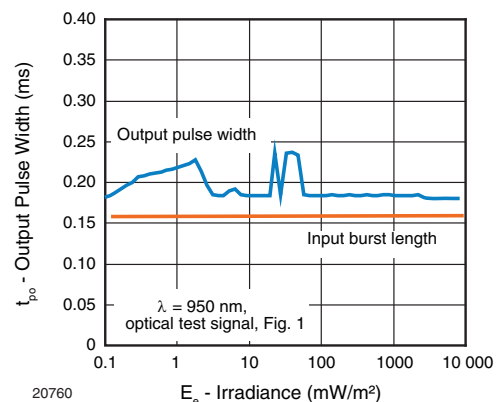


Fig. 2 - Pulse Length and Sensitivity in Dark Ambient

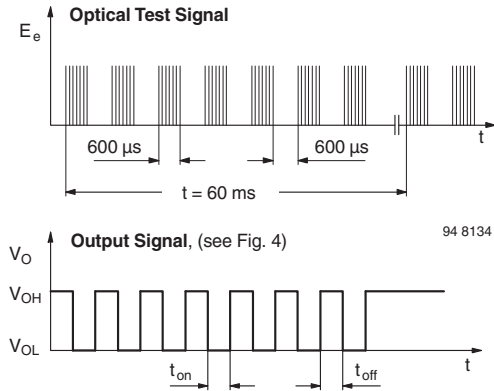


Fig. 3 - Output Function

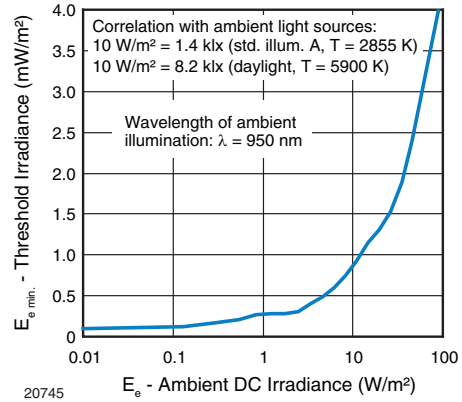


Fig. 6 - Sensitivity in Bright Ambient

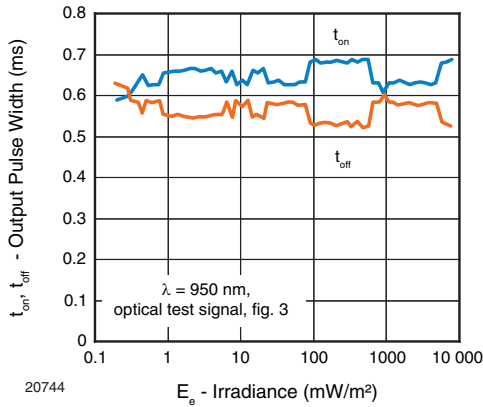


Fig. 4 - Output Pulse Diagram

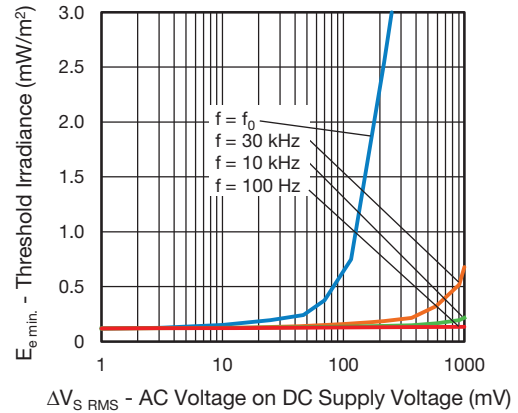


Fig. 7 - Sensitivity vs. Supply Voltage Disturbances

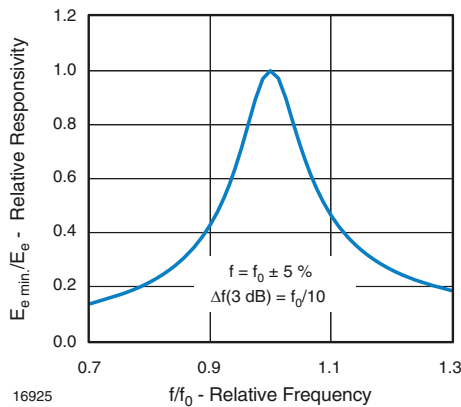


Fig. 5 - Frequency Dependence of Responsivity

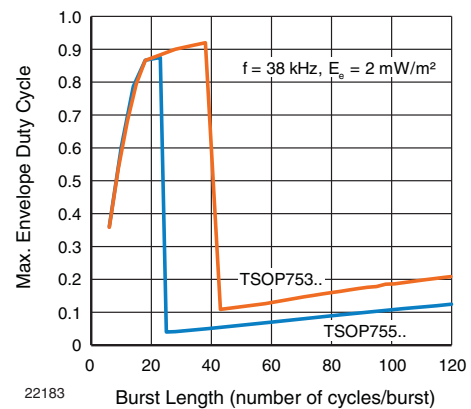


Fig. 8 - Max. Envelope Duty Cycle vs. Burst Length

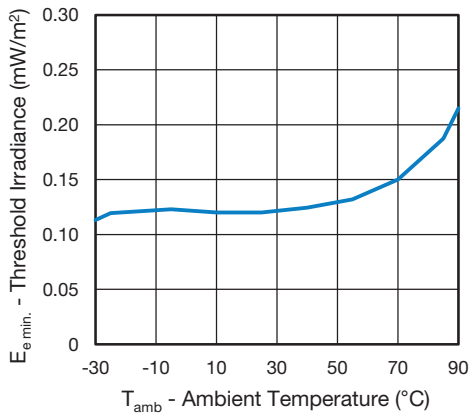


Fig. 9 - Sensitivity vs. Ambient Temperature

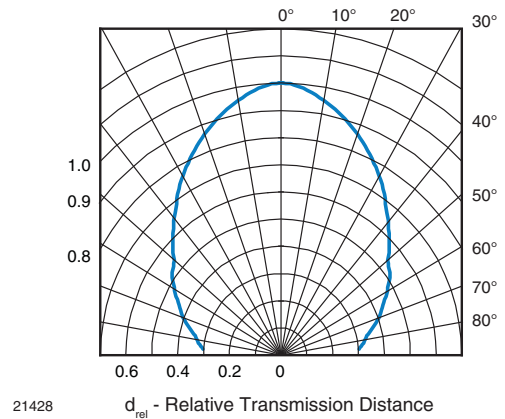


Fig. 12 - Vertical Directivity

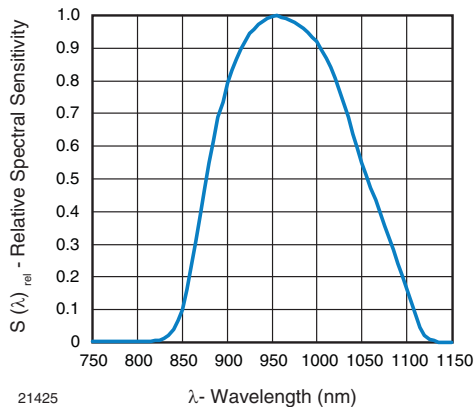


Fig. 10 - Relative Spectral Sensitivity vs. Wavelength

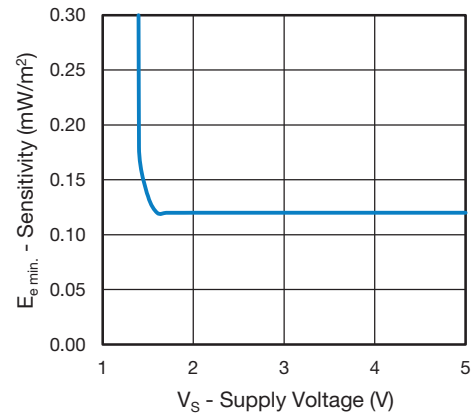


Fig. 13 - Sensitivity vs. Supply Voltage

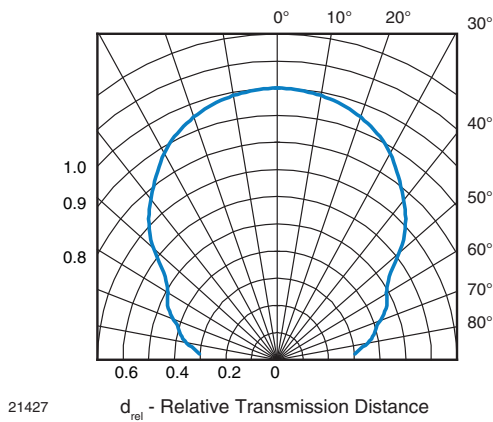


Fig. 11 - Horizontal Directivity

**SUITABLE DATA FORMAT**

The TSOP753.., TSOP755.. series are designed to suppress spurious output pulses due to noise or disturbance signals. Data and disturbance signals can be distinguished by the devices according to carrier frequency, burst length and envelope duty cycle. The data signal should be close to the band-pass center frequency (e.g. 38 kHz) and fulfill the conditions in the table below.

When a data signal is applied to the TSOP753.. and TSOP755.. in the presence of a disturbance signal, the sensitivity of the receiver is reduced to insure that no spurious pulses are present at the output. Some examples of disturbance signals which are suppressed are:

- DC light (e.g. from tungsten bulb or sunlight)
- Continuous signals at any frequency
- Strongly or weakly modulated pattern from fluorescent lamps with electronic ballasts (see Fig. 14 or Fig. 15)



Fig. 14 - IR Disturbance from Fluorescent Lamp With Low Modulation



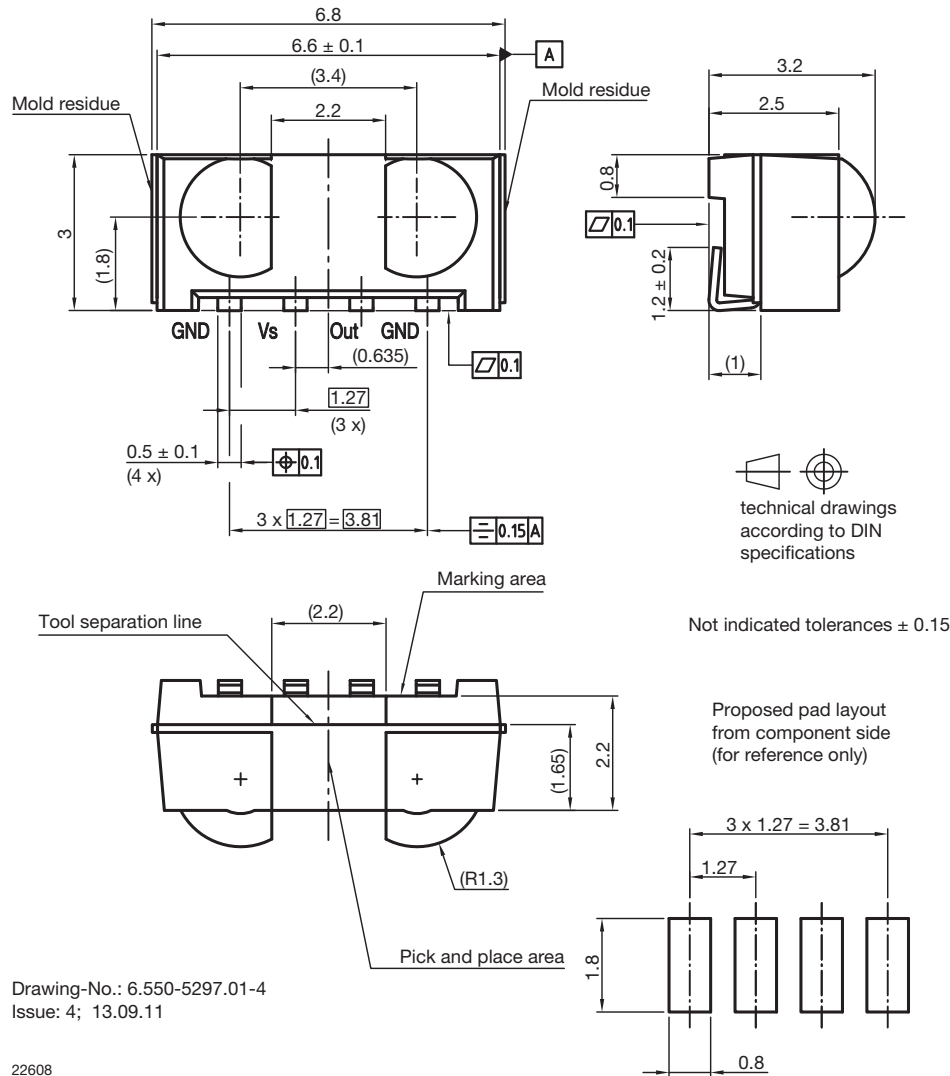
Fig. 15 - IR Disturbance from Fluorescent Lamp With High Modulation

	<b>TSOP753..</b>	<b>TSOP755..</b>
Minimum burst length	6 cycles/burst	6 cycles/burst
After each burst of length a minimum gap time is required of	6 to 35 cycles ≥ 10 cycles	6 to 24 cycles ≥ 10 cycles
For bursts greater than a minimum gap time in the data stream is needed of	35 cycles > 4 x burst length	24 cycles > 25 ms
Maximum number of continuous short bursts/second	2000	2000
MCIR code	Preferred	Yes
RCMM code	Preferred	Yes
XMP-1, XMP-2 code	Preferred	Yes
Suppression of interference from fluorescent lamps	Mild and complex disturbance patterns are suppressed (example: signal pattern of Fig. 14 and Fig. 15)	Critical disturbance patterns are suppressed, e.g. highly dimmed LCDs

**Note**

- For data formats with long bursts please see the datasheet for TSOP752.., TSOP754..

**PACKAGE DIMENSIONS** in millimeters



**ASSEMBLY INSTRUCTIONS**

**Reflow Soldering**

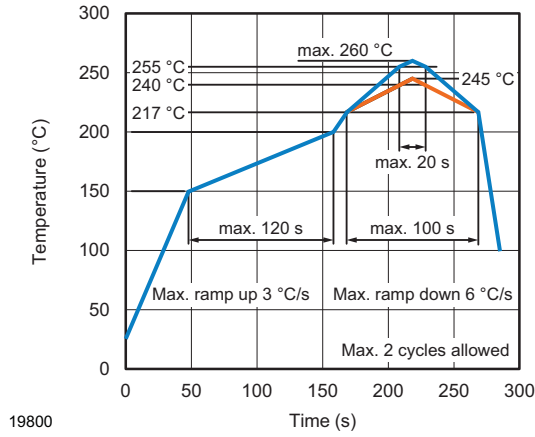
- Reflow soldering must be done within 72 h while stored under a max. temperature of 30 °C, 60 % RH after opening the dry pack envelope
- Set the furnace temperatures for pre-heating and heating in accordance with the reflow temperature profile as shown in the diagram. Exercise extreme care to keep the maximum temperature below 260 °C. The temperature shown in the profile means the temperature at the device surface. Since there is a temperature difference between the component and the circuit board, it should be verified that the temperature of the device is accurately being measured
- Handling after reflow should be done only after the work surface has been cooled off

**Manual Soldering**

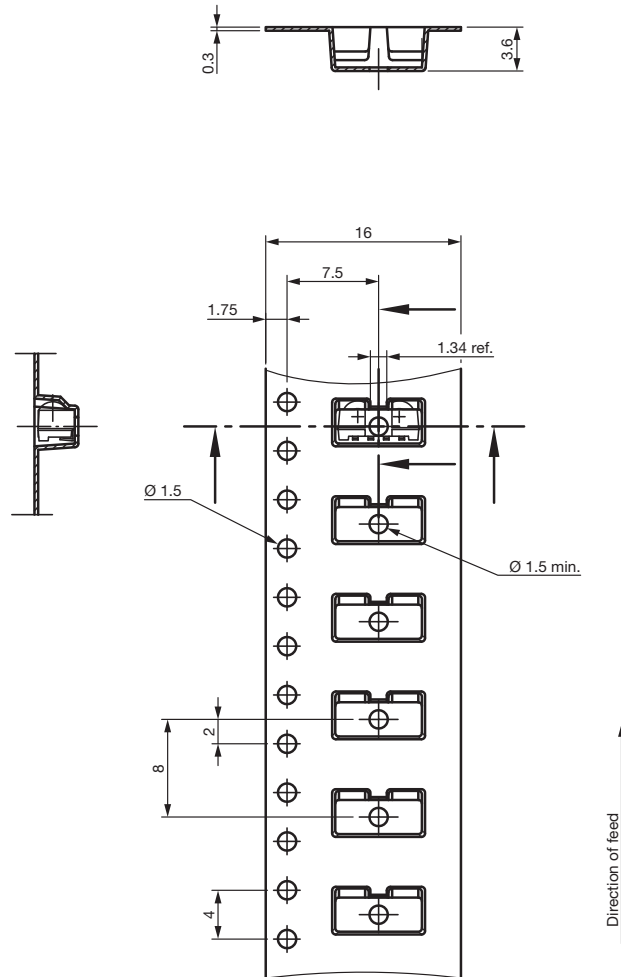
- Use a soldering iron of 25 W or less. Adjust the temperature of the soldering iron below 300 °C
- Finish soldering within 3 s
- Handle products only after the temperature has cooled off



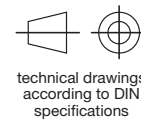
VISHAY LEAD (Pb)-FREE REFLOW SOLDER PROFILE



TAPING VERSION TSOP..TR DIMENSIONS in millimeters

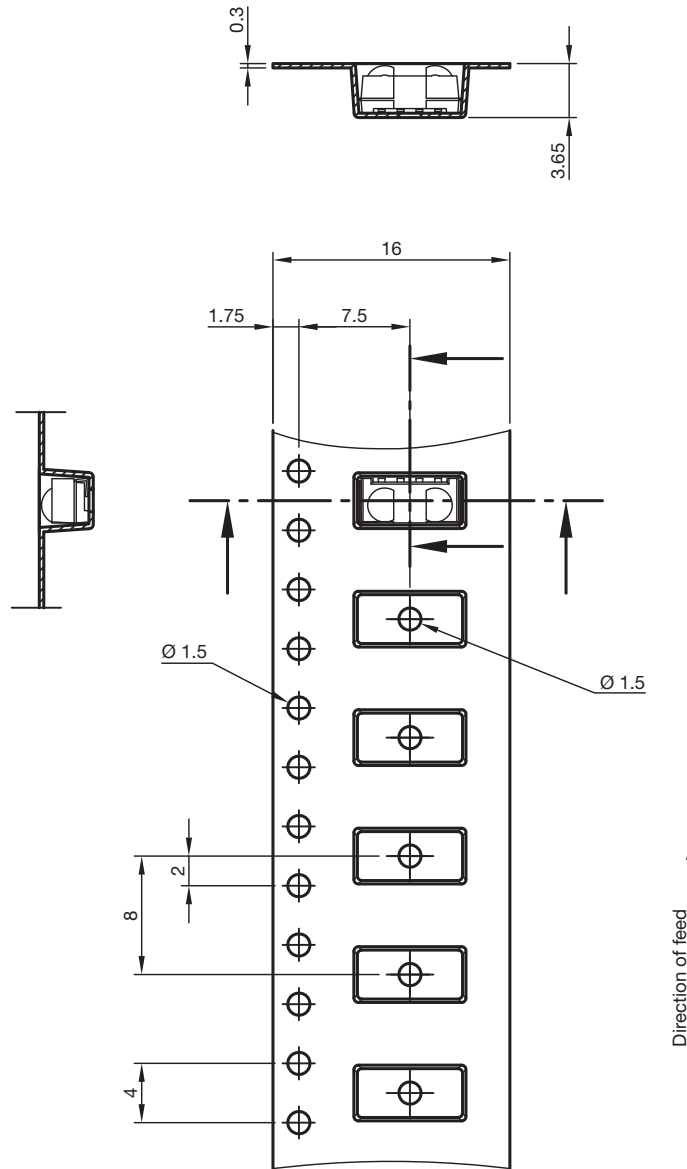


Drawing-No.: 9.700-5337.01-4  
Issue: 2; 06.10.15

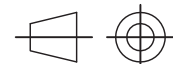




## TAPING VERSION TSOP..TT DIMENSIONS in millimeters



Drawing-No.: 9.700-5338.01-4  
Issue: 4; 12.06.13

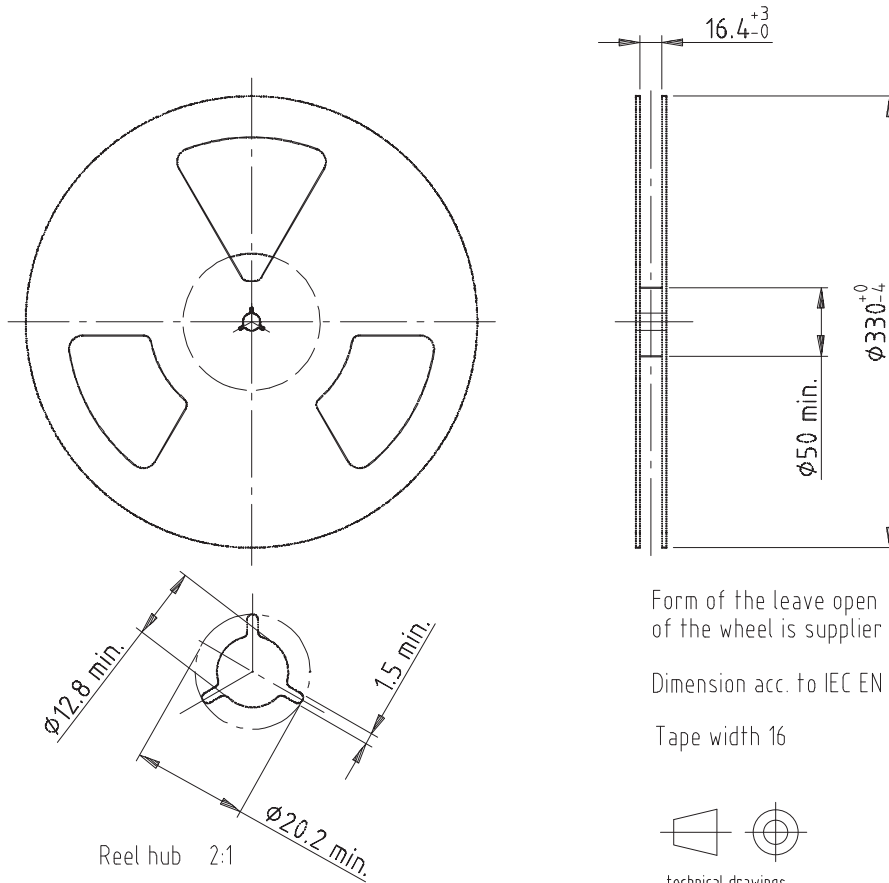


technical drawings  
according to DIN  
specifications





REEL DIMENSIONS in millimeters



Reel hub 2:1

Drawing-No.: 9.800-5052.V2-4

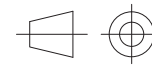
Issue: 1; 07.05.02

16734

Form of the leave open of the wheel is supplier specific.

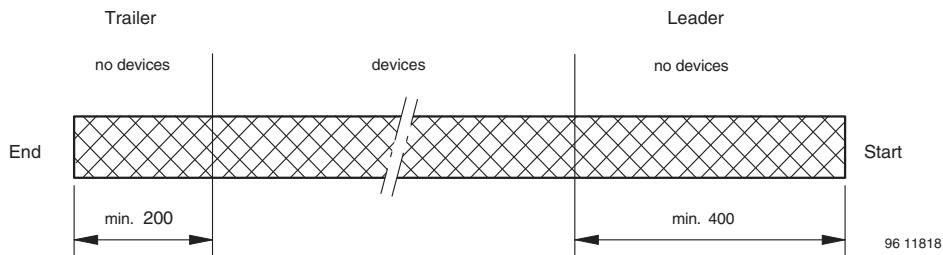
Dimension acc. to IEC EN 60 286-3

Tape width 16



technical drawings according to DIN specifications

LEADER AND TRAILER DIMENSIONS in millimeters



COVER TAPE PEEL STRENGTH

According to DIN EN 60286-3

0.1 N to 1.3 N

300 ± 10 mm/min.

165° to 180° peel angle

LABEL

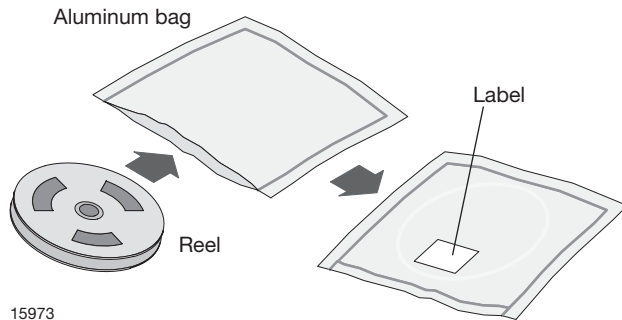
Standard bar code labels for finished goods

The standard bar code labels are product labels and used for identification of goods. The finished goods are packed in final packing area. The standard packing units are labeled with standard bar code labels before transported as finished goods to warehouses. The labels are on each packing unit and contain Vishay Semiconductor GmbH specific data.

<b>VISHAY SEMICONDUCTOR GmbH STANDARD BAR CODE PRODUCT LABEL (finished goods)</b>		
<b>PLAIN WRITING</b>	<b>ABBREVIATION</b>	<b>LENGTH</b>
Item-description	-	18
Item-number	INO	8
Selection-code	SEL	3
LOT-/serial-number	BATCH	10
Data-code	COD	3 (YWW)
Plant-code	PTC	2
Quantity	QTY	8
Accepted by	ACC	-
Packed by	PCK	-
Mixed code indicator	MIXED CODE	-
Origin	xxxxxxx+	Company logo
<b>LONG BAR CODE TOP</b>	<b>TYPE</b>	<b>LENGTH</b>
Item-number	N	8
Plant-code	N	2
Sequence-number	X	3
Quantity	N	8
Total length	-	21
<b>SHORT BAR CODE BOTTOM</b>	<b>TYPE</b>	<b>LENGTH</b>
Selection-code	X	3
Data-code	N	3
Batch-number	X	10
Filter	-	1
Total length	-	17

### DRY PACKING

The reel is packed in an anti-humidity bag to protect the devices from absorbing moisture during transportation and storage.



### FINAL PACKING

The sealed reel is packed into a cardboard box.

### RECOMMENDED METHOD OF STORAGE

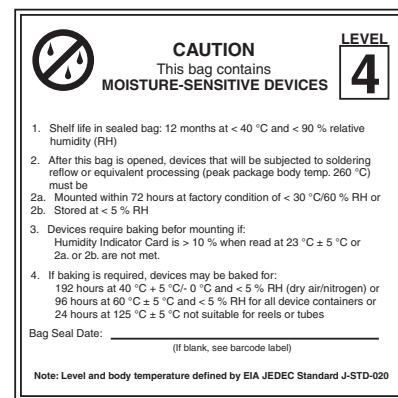
Dry box storage is recommended as soon as the aluminum bag has been opened to prevent moisture absorption. The following conditions should be observed, if dry boxes are not available:

- Storage temperature 10 °C to 30 °C
- Storage humidity ≤ 60 % RH max.

After more than 72 h under these conditions moisture content will be too high for reflow soldering.

In case of moisture absorption, the devices will recover to the former condition by drying under the following condition:  
 192 h at 40 °C + 5 °C / - 0 °C and < 5 % RH (dry air / nitrogen) or  
 96 h at 60 °C + 5 °C and < 5 % RH for all device containers or  
 24 h at 125 °C + 5 °C not suitable for reel or tubes.

An EIA JEDEC® standard J-STD-020 level 4 label is included on all dry bags.



EIA JEDEC standard J-STD-020 level 4 label is included on all dry bags



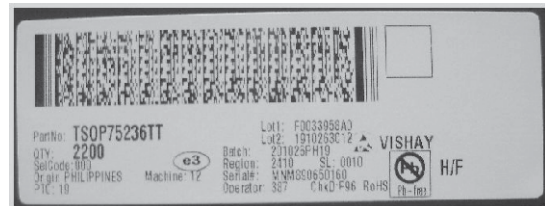
### ESD PRECAUTION

Proper storage and handling procedures should be followed to prevent ESD damage to the devices especially when they are removed from the antistatic shielding bag. Electrostatic sensitive devices warning labels are on the packaging.

### VISHAY SEMICONDUCTORS STANDARD BAR CODE LABELS

The Vishay Semiconductors standard bar code labels are printed at final packing areas. The labels are on each packing unit and contain Vishay Semiconductors specific data.

### BAR CODE PRODUCT LABEL (example)



22178



## **Disclaimer**

ALL PRODUCT, PRODUCT SPECIFICATIONS AND DATA ARE SUBJECT TO CHANGE WITHOUT NOTICE TO IMPROVE RELIABILITY, FUNCTION OR DESIGN OR OTHERWISE.

Vishay Intertechnology, Inc., its affiliates, agents, and employees, and all persons acting on its or their behalf (collectively, "Vishay"), disclaim any and all liability for any errors, inaccuracies or incompleteness contained in any datasheet or in any other disclosure relating to any product.

Vishay makes no warranty, representation or guarantee regarding the suitability of the products for any particular purpose or the continuing production of any product. To the maximum extent permitted by applicable law, Vishay disclaims (i) any and all liability arising out of the application or use of any product, (ii) any and all liability, including without limitation special, consequential or incidental damages, and (iii) any and all implied warranties, including warranties of fitness for particular purpose, non-infringement and merchantability.

Statements regarding the suitability of products for certain types of applications are based on Vishay's knowledge of typical requirements that are often placed on Vishay products in generic applications. Such statements are not binding statements about the suitability of products for a particular application. It is the customer's responsibility to validate that a particular product with the properties described in the product specification is suitable for use in a particular application. Parameters provided in datasheets and / or specifications may vary in different applications and performance may vary over time. All operating parameters, including typical parameters, must be validated for each customer application by the customer's technical experts. Product specifications do not expand or otherwise modify Vishay's terms and conditions of purchase, including but not limited to the warranty expressed therein.

Except as expressly indicated in writing, Vishay products are not designed for use in medical, life-saving, or life-sustaining applications or for any other application in which the failure of the Vishay product could result in personal injury or death. Customers using or selling Vishay products not expressly indicated for use in such applications do so at their own risk. Please contact authorized Vishay personnel to obtain written terms and conditions regarding products designed for such applications.

No license, express or implied, by estoppel or otherwise, to any intellectual property rights is granted by this document or by any conduct of Vishay. Product names and markings noted herein may be trademarks of their respective owners.