

## IR Receiver Modules for Remote Control Systems



### FEATURES

- Improved dark sensitivity
- Improved immunity against optical noise
- Very low supply current
- Photo detector and preamplifier in one package
- Internal filter for PCM frequency
- Supply voltage: 2.0 V to 3.6 V
- Insensitive to supply voltage ripple and noise
- Material categorization:  
for definitions of compliance please see [www.vishay.com/doc?99912](http://www.vishay.com/doc?99912)



### ADDITIONAL RESOURCES



### MECHANICAL DATA

1 = OUT, 2 = GND, 3 = V<sub>S</sub>

### DESCRIPTION

The TSOP93...P10TR series devices are the latest generation miniaturized IR receiver modules for infrared remote control systems. These series provide improvements in sensitivity to remote control signals in dark ambient as well as in sensitivity in the presence of optical disturbances e.g. from CFLs.

The devices contain a PIN diode and a preamplifier assembled on a lead frame. The epoxy package contains an IR filter. The demodulated output signal can be directly connected to a microprocessor for decoding.

The TSOP936...,P10TR series devices are designed to receive long burst codes (10 or more carrier cycles per burst). The third digit designates the AGC level (AGC6) and the last two digits designate the band-pass frequency (see table below). The higher the AGC, the better noise is suppressed, but the lower the code compatibility. AGC6 provides maximized noise suppression. Generally, we advise to select the highest AGC that satisfactorily receives the desired remote code.

These components have not been qualified to automotive specifications.

PARTS TABLE		
AGC	MAXIMIZED NOISE SUPPRESSION (AGC6)	
Carrier frequency	30 kHz	TSOP93630P10TR
	33 kHz	TSOP93633P10TR
	36 kHz	TSOP93636P10TR <sup>(5)(6)</sup>
	38 kHz	TSOP93638P10TR <sup>(3)(4)(11)</sup>
	40 kHz	TSOP93640P10TR
	56 kHz	TSOP93656P10TR
Package	Minimold	
Pinning	1 = OUT, 2 = GND, 3 = V <sub>S</sub>	
Dimensions (mm)	5.4 W x 6.35 H x 4.9 D	
Mounting	Leaded	
Application	Remote control	
Best choice for	<sup>(1)</sup> Cisco <sup>(2)</sup> MCIR <sup>(3)</sup> Mitsubishi <sup>(4)</sup> NEC <sup>(5)</sup> Panasonic <sup>(6)</sup> RC-5 <sup>(7)</sup> RC-6 <sup>(8)</sup> RCA <sup>(9)</sup> r-step <sup>(10)</sup> Sejin 4PPM <sup>(11)</sup> Sharp <sup>(12)</sup> Sony	

### Notes

- 30 kHz and 33 kHz only available on written request
- See datasheet for TSOP932..P10TR, TSOP934..P10TR for preferred devices for <sup>(1)(2)(7)(8)(9)(10)(12)</sup>

## BLOCK DIAGRAM

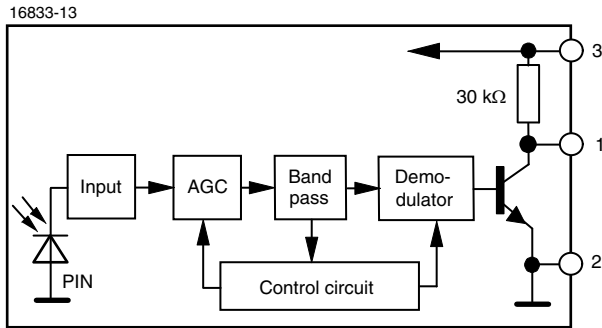

## APPLICATION CIRCUIT

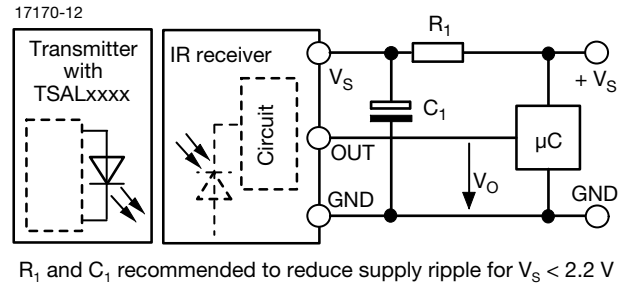

## ABSOLUTE MAXIMUM RATINGS

PARAMETER	TEST CONDITION	SYMBOL	VALUE	UNIT
Supply voltage		$V_S$	-0.3 to +3.6	V
Supply current		$I_S$	3	mA
Output voltage		$V_O$	-0.3 to $(V_S + 0.3)$	V
Output current		$I_O$	5	mA
Junction temperature		$T_j$	100	°C
Storage temperature range		$T_{stg}$	-25 to +85	°C
Operating temperature range		$T_{amb}$	-25 to +85	°C
Power consumption	$T_{amb} \leq 85\text{ °C}$	$P_{tot}$	10	mW
Soldering temperature	$t \leq 10\text{ s}$ , 1 mm from case	$T_{sd}$	260	°C

### Note

- Stresses beyond those listed under “Absolute Maximum Ratings” may cause permanent damage to the device. This is a stress rating only and functional operation of the device at these or any other conditions beyond those indicated in the operational sections of this specification is not implied. Exposure to absolute maximum rating conditions for extended periods may affect the device reliability

## ELECTRICAL AND OPTICAL CHARACTERISTICS ( $T_{amb} = 25\text{ °C}$ , unless otherwise specified)

PARAMETER	TEST CONDITION	SYMBOL	MIN.	TYP.	MAX.	UNIT
Supply current	$E_v = 0$ , $V_S = 3.3\text{ V}$	$I_{SD}$	0.25	0.37	0.45	mA
	$E_v = 40\text{ klx}$ , sunlight	$I_{SH}$	-	0.50	-	mA
Supply voltage		$V_S$	2.0	-	3.6	V
Transmission distance	$E_v = 0$ , test signal see Fig. 1, IR diode TSAL6200, $I_F = 50\text{ mA}$	$d$	-	32	-	m
Output voltage low	$I_{OSL} = 0.5\text{ mA}$ , $E_e = 0.7\text{ mW/m}^2$ , test signal see Fig. 1	$V_{OSL}$	-	-	100	mV
Minimum irradiance	Test signal: NEC code	$E_e\text{ min.}$	-	0.07	0.15	$\text{mW/m}^2$
Maximum irradiance	$t_{pi} - 5/f_0 < t_{po} < t_{pi} + 6/f_0$ , test signal see Fig. 1	$E_e\text{ max.}$	30	-	-	$\text{W/m}^2$
Directivity	Angle of half transmission distance	$\phi_{1/2}$	-	$\pm 45$	-	°

**TYPICAL CHARACTERISTICS** ( $T_{amb} = 25\text{ }^{\circ}\text{C}$ , unless otherwise specified)

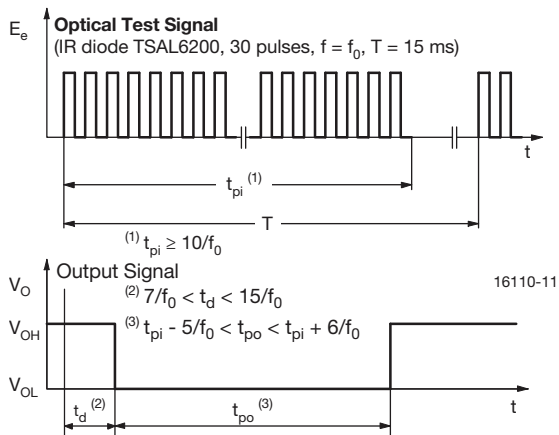

Fig. 1 - Output Delay and Pulse-Width

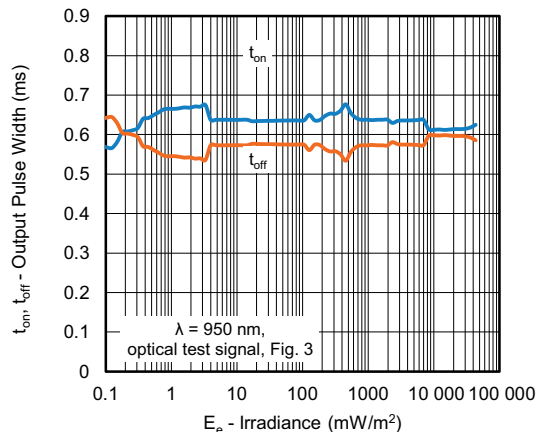

Fig. 4 - Pulse-Width vs. Irradiance in Dark Ambient

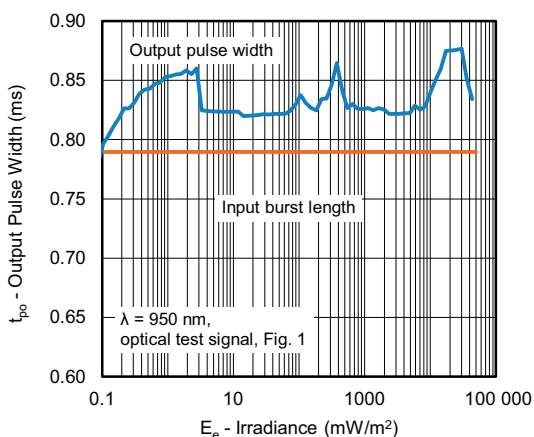

Fig. 2 - Pulse-Width vs. Irradiance in Dark Ambient

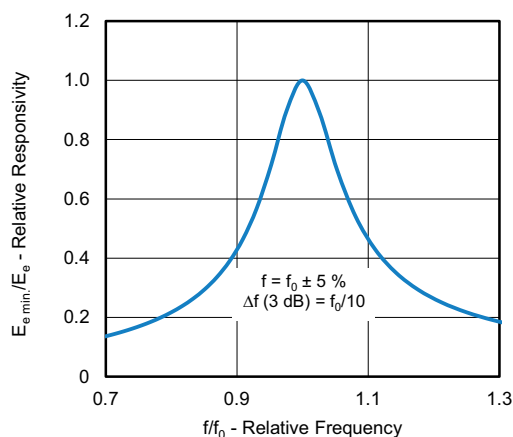

Fig. 5 - Frequency Dependence of Responsivity

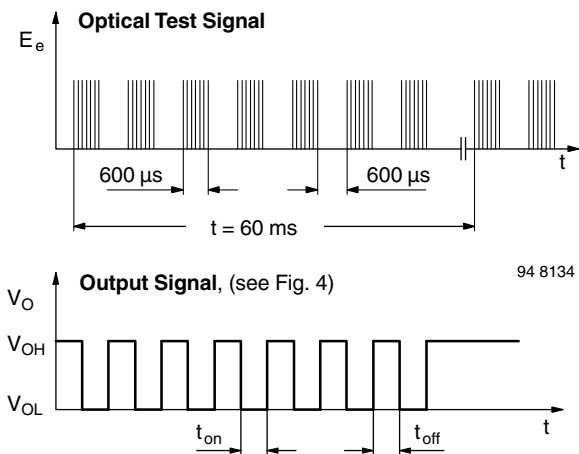

Fig. 3 - Test Signal

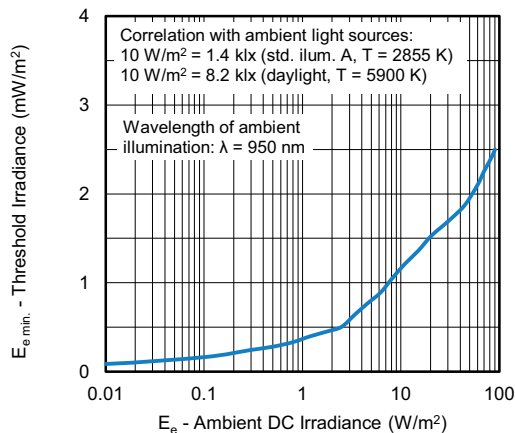

Fig. 6 - Sensitivity in Bright Ambient

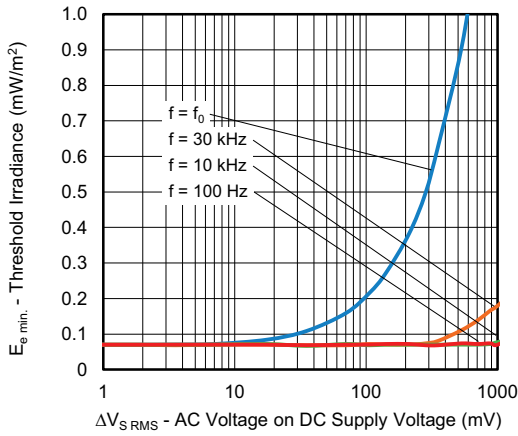

Fig. 7 - Sensitivity vs. Supply Voltage Disturbances

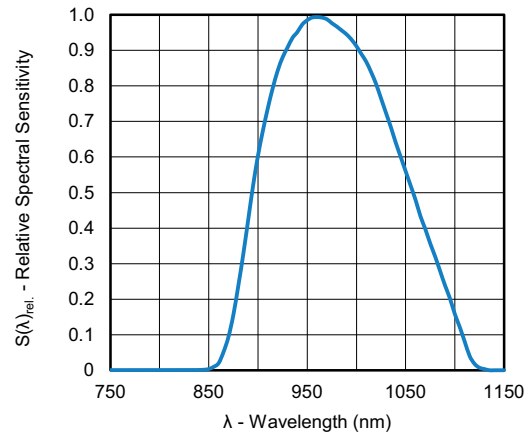

Fig. 10 - Relative Spectral Sensitivity vs. Wavelength

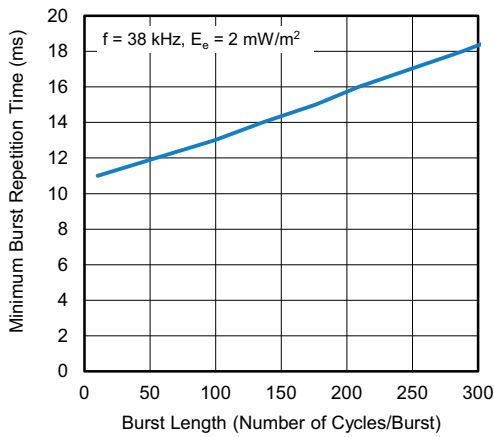

Fig. 8 - Minimum Burst Repetition Time vs. Burst Length

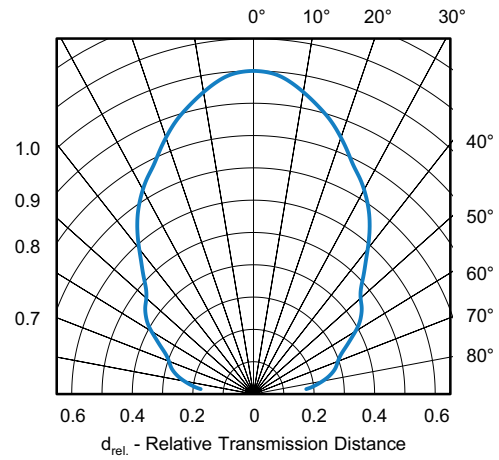

Fig. 11 - Directivity

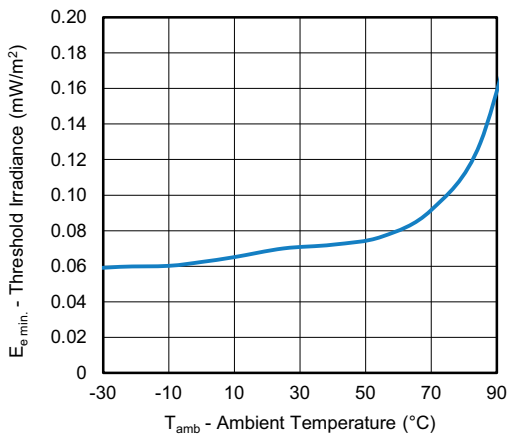

Fig. 9 - Sensitivity vs. Ambient Temperature

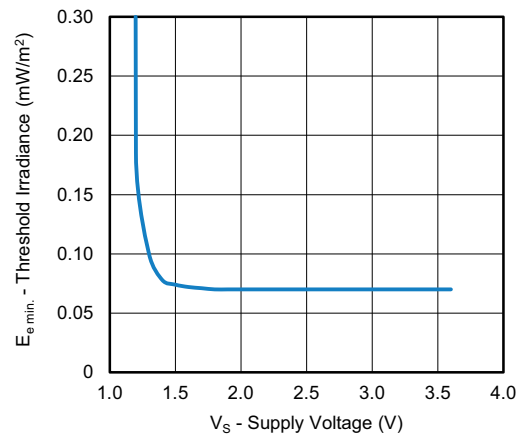

Fig. 12 - Sensitivity vs. Supply Voltage

## SUITABLE DATA FORMAT

This series is designed to suppress spurious output pulses due to noise or disturbance signals. The devices can distinguish data signals from noise due to differences in frequency, burst length, and envelope duty cycle. The data signal should be close to the device's band-pass center frequency (e.g. 38 kHz) and fulfill the conditions in the table below.

When a data signal is applied to the product in the presence of a disturbance, the sensitivity of the receiver is automatically reduced by the AGC to insure that no spurious pulses are present at the receiver's output. Some examples which are suppressed are:

- DC light (e.g. from tungsten bulbs sunlight)
- Continuous signals at any frequency
- Strongly or weakly modulated patterns from fluorescent lamps with electronic ballasts (see Fig. 13 or Fig. 14)

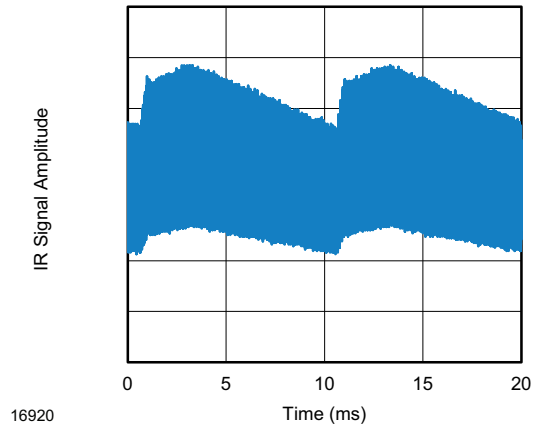

Fig. 13 - IR Emission from Fluorescent Lamp With Low Modulation

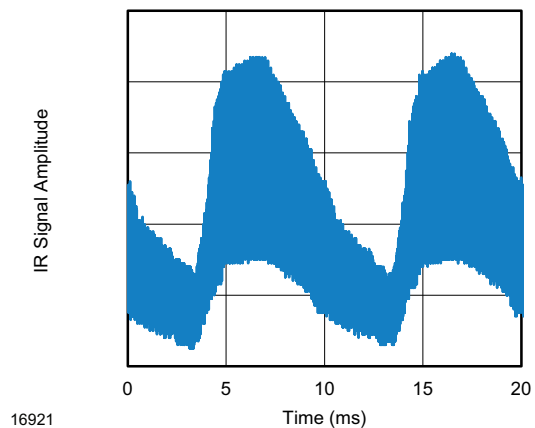

Fig. 14 - IR Emission from Fluorescent Lamp With High Modulation

	<b>TSOP936..P10TR</b>
Minimum burst length	10 cycles/burst
Minimum gap time between bursts	≥ 13 cycles
Minimum idle period between data frames	12 ms
RC-5 code	Preferred
RC-6 code	Yes
NEC code	Preferred
r-step code 56 kHz	Yes
Sony code	No
RCA 56 kHz code	Yes
Mitsubishi code 38 kHz	Preferred
Suppression of interference from fluorescent lamps	Fig. 13 and Fig. 14

### Note

- For data formats with short bursts please see the datasheet for TSOP933..P10TR, TSOP935..P10TR



**SIDE VIEW PIN-IN-PASTE HOLDER: D = 9.0 mm, H = 8.05 mm, W = 6.2 mm, X = 5.15 mm**



22940

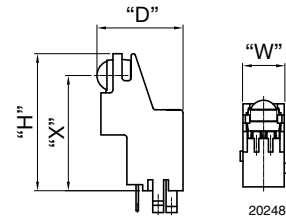

20248

NAME	LENS AXIS (X)	VIEW	TYPE	HEIGHT (H)	WIDTH (W)	DEPTH (D)
P10TR	5.15	Side	Holder	8.05	6.2	9.0

**MECHANICAL DIMENSIONS** in millimeters

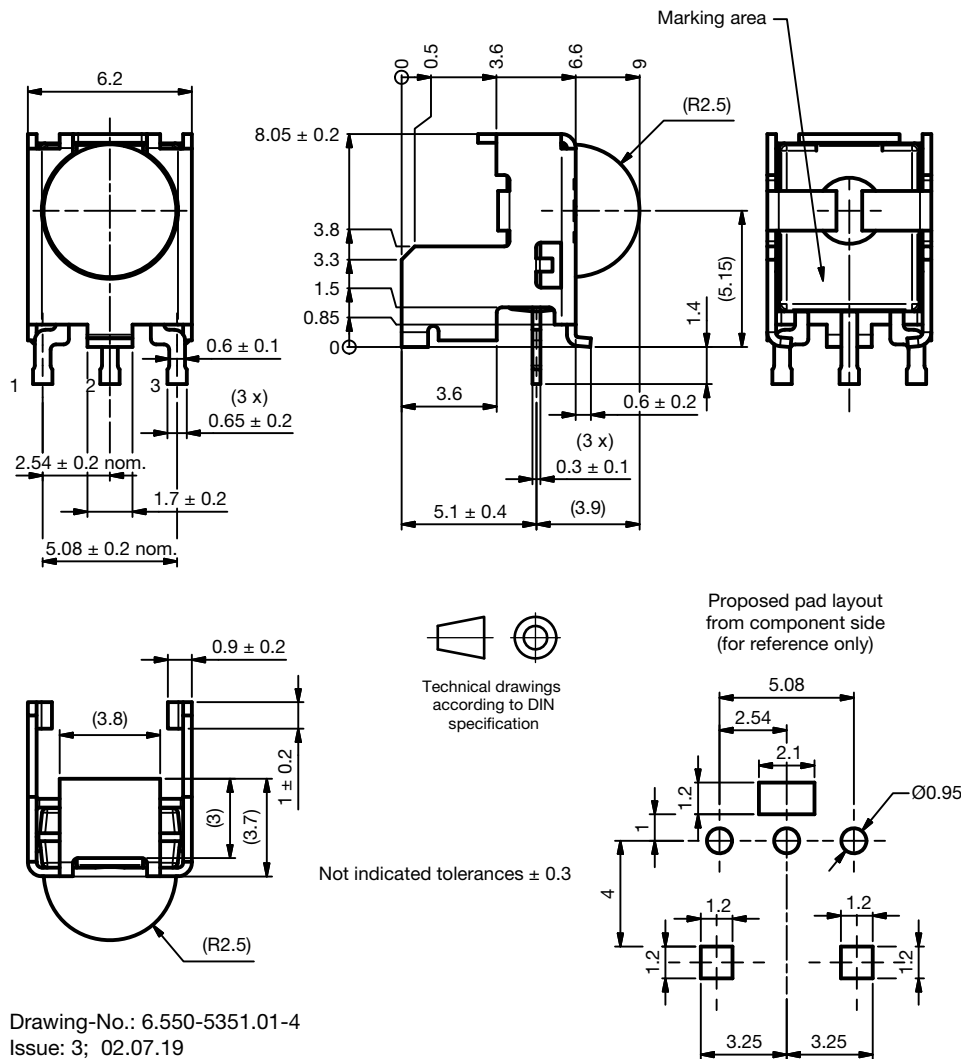



**TAPING VERSION TSOP..TR DIMENSIONS** in millimeters

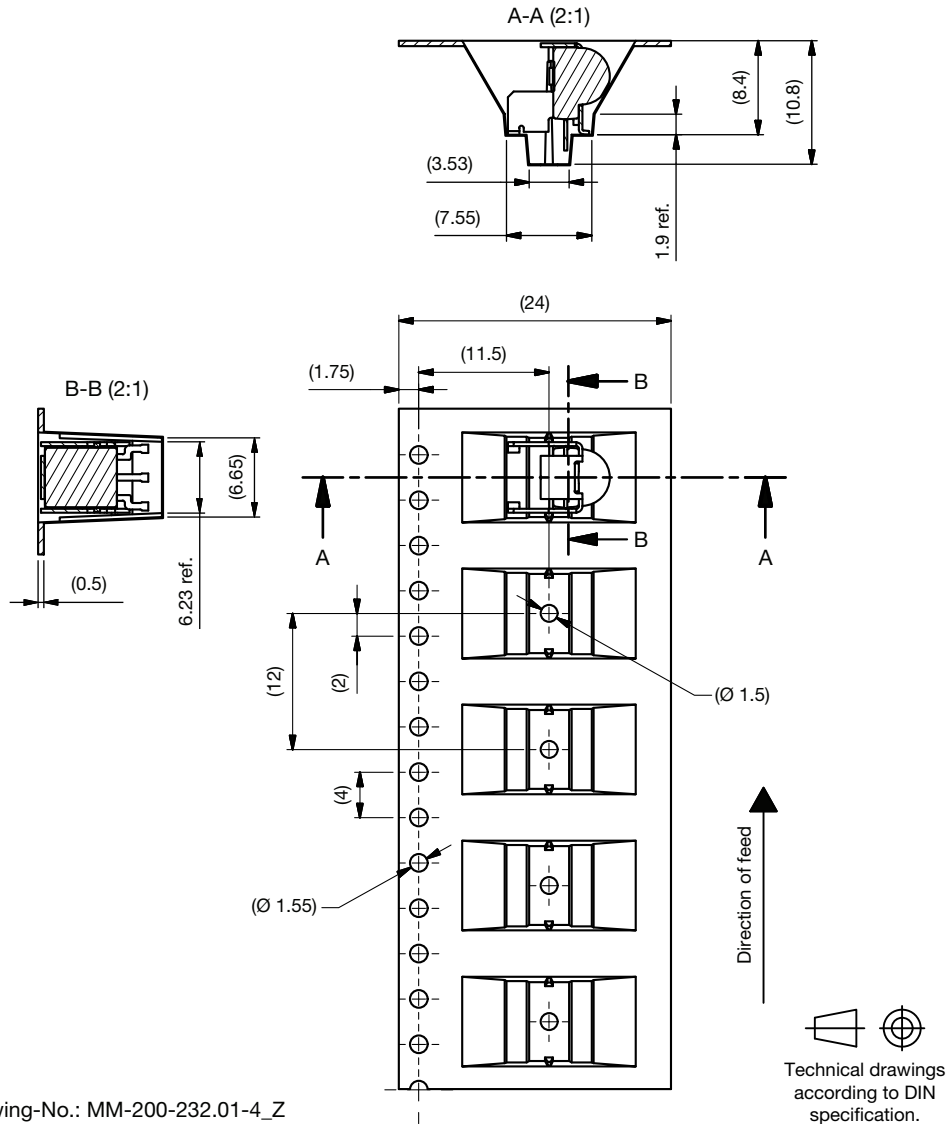

Drawing-No.: MM-200-232.01-4\_Z  
Issue A: 25.04.17

**ORDERING INFORMATION**

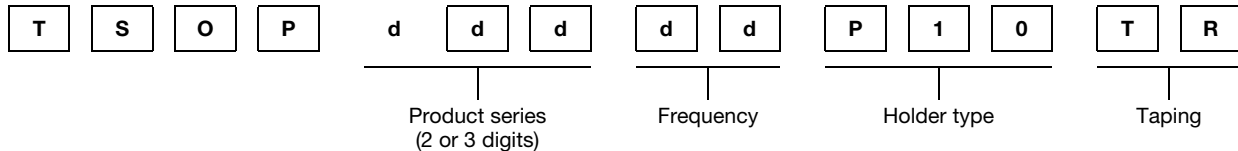

**Note**

- d = "digit", please consult the list of available series on the previous page to create a valid part number

**Example: TSOP93638P10TR**

**PACKAGING QUANTITY**

- 500 pieces per reel



**REEL DIMENSIONS** in millimeters

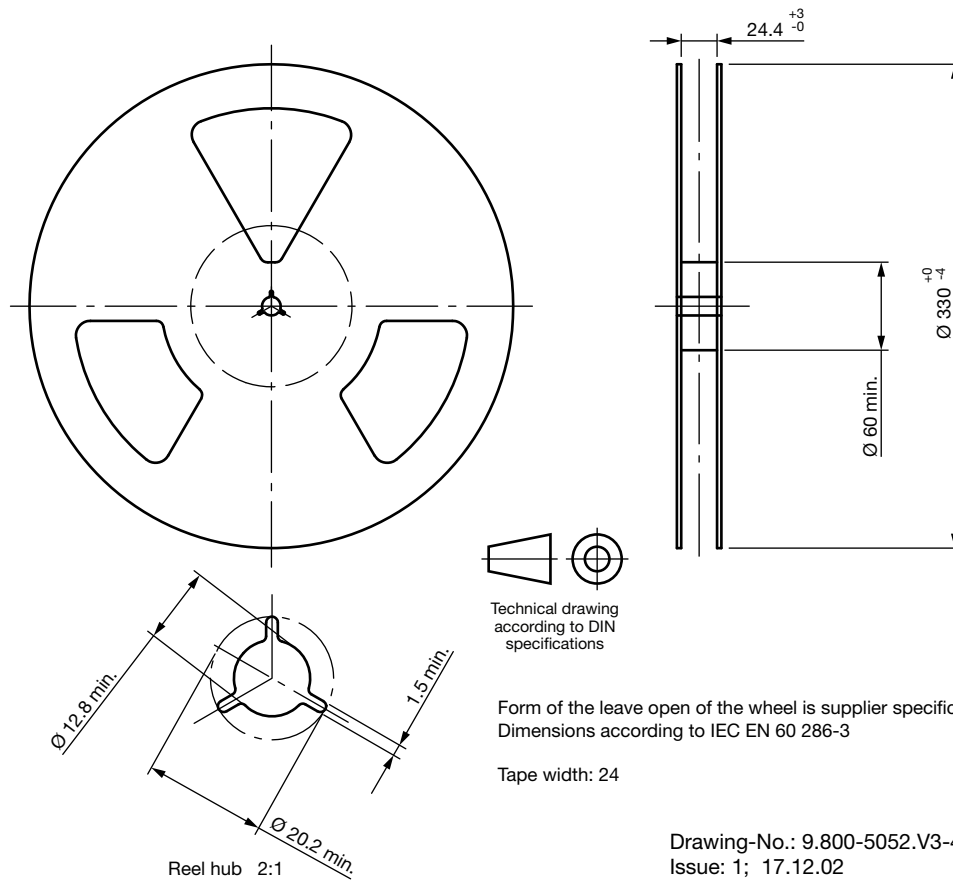

**LEADER AND TRAILER DIMENSIONS** in millimeters

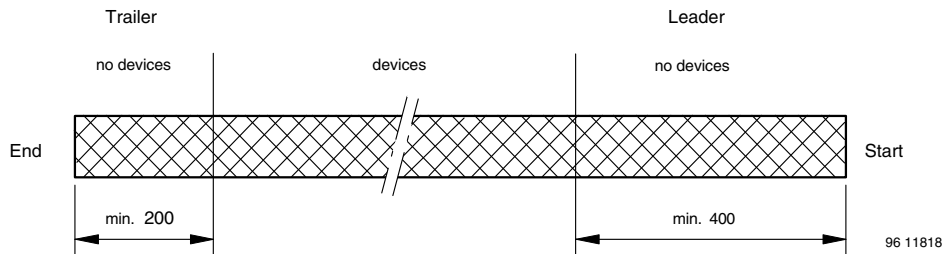

**COVER TAPE PEEL STRENGTH**

According to DIN EN 60286-3

0.1 N to 1.3 N

300 ± 10 mm/min.

165° to 180° peel angle





**ASSEMBLY INSTRUCTIONS**

**Reflow Soldering**

- Reflow soldering must be done within 72 h while stored under a max. temperature of 30 °C, 60 % RH after opening the dry pack envelope
- Set the furnace temperatures for pre-heating and heating in accordance with the reflow temperature profile as shown in the diagram. Exercise extreme care to keep the maximum temperature below 260 °C. The temperature shown in the profile means the temperature at the device surface. Since there is a temperature difference between the component and the circuit board, it should be verified that the temperature of the device is accurately being measured
- Handling after reflow should be done only after the work surface has been cooled off

**Manual Soldering**

- Use a soldering iron of 25 W or less. Adjust the temperature of the soldering iron below 300 °C
- Finish soldering within 3 s
- Handle products only after the temperature has cooled off

**VISHAY LEAD (Pb)-FREE REFLOW SOLDER PROFILE**

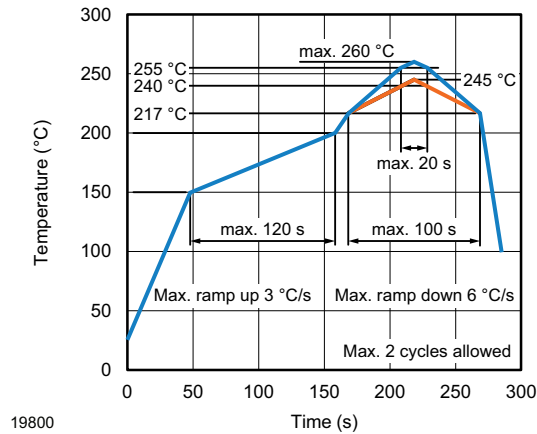

**LABEL**

**Standard bar code labels for finished goods**

The standard bar code labels are product labels and used for identification of goods. The finished goods are packed in final packing area. The standard packing units are labeled with standard bar code labels before transported as finished goods to warehouses. The labels are on each packing unit and contain Vishay Semiconductor GmbH specific data.



<b>VISHAY SEMICONDUCTOR GmbH STANDARD BAR CODE PRODUCT LABEL (finished goods)</b>		
<b>PLAIN WRITING</b>	<b>ABBREVIATION</b>	<b>LENGTH</b>
Item-description	-	18
Item-number	INO	8
Selection-code	SEL	3
LOT-/serial-number	BATCH	10
Data-code	COD	3 (YWW)
Plant-code	PTC	2
Quantity	QTY	8
Accepted by	ACC	-
Packed by	PCK	-
Mixed code indicator	MIXED CODE	-
Origin	xxxxxxx+	Company logo
<b>LONG BAR CODE TOP</b>	<b>TYPE</b>	<b>LENGTH</b>
Item-number	N	8
Plant-code	N	2
Sequence-number	X	3
Quantity	N	8
Total length	-	21
<b>SHORT BAR CODE BOTTOM</b>	<b>TYPE</b>	<b>LENGTH</b>
Selection-code	X	3
Data-code	N	3
Batch-number	X	10
Filter	-	1
Total length	-	17

**DRY PACKING**

The reel is packed in an anti-humidity bag to protect the devices from absorbing moisture during transportation and storage.

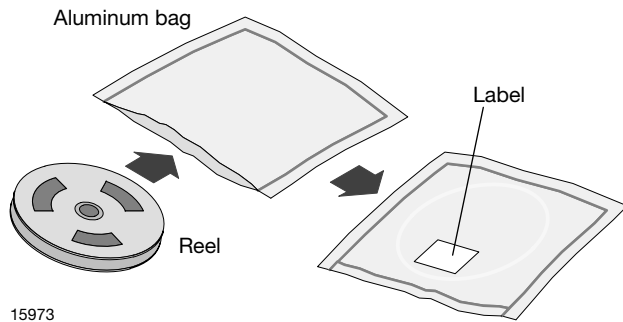

**FINAL PACKING**

The sealed reel is packed into a cardboard box. A secondary cardboard box is used for shipping purposes.



**RECOMMENDED METHOD OF STORAGE**

Dry box storage is recommended as soon as the aluminum bag has been opened to prevent moisture absorption. The following conditions should be observed, if dry boxes are not available:

- Storage temperature 10 °C to 30 °C
- Storage humidity ≤ 60 % RH max.

After more than 72 h under these conditions moisture content will be too high for reflow soldering.

In case of moisture absorption, the devices will recover to the former condition by drying under the following condition:

- 192 h at 40 °C + 5 °C / - 0 °C and < 5 % RH (dry air / nitrogen) or
- 96 h at 60 °C + 5 °C and < 5 % RH for all device containers or
- 24 h at 125 °C + 5 °C not suitable for reel or tubes.

An EIA JEDEC® standard J-STD-020 level 4 label is included on all dry bags.

**ESD PRECAUTION**

Proper storage and handling procedures should be followed to prevent ESD damage to the devices especially when they are removed from the antistatic shielding bag. Electrostatic sensitive devices warning labels are on the packaging.

**VISHAY SEMICONDUCTORS STANDARD BAR CODE LABELS**

The Vishay Semiconductors standard bar code labels are printed at final packing areas. The labels are on each packing unit and contain Vishay Semiconductors specific data.



22645

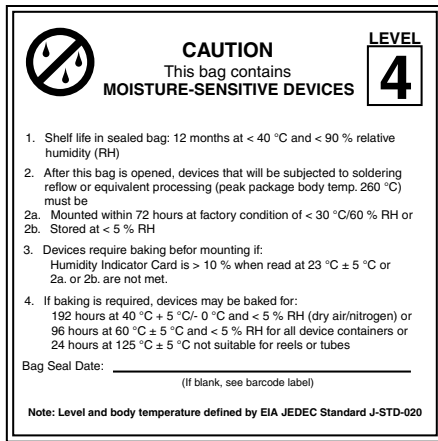

22522

EIA JEDEC standard J-STD-020 level 4 label is included on all dry bags



## **Disclaimer**

ALL PRODUCT, PRODUCT SPECIFICATIONS AND DATA ARE SUBJECT TO CHANGE WITHOUT NOTICE TO IMPROVE RELIABILITY, FUNCTION OR DESIGN OR OTHERWISE.

Vishay Intertechnology, Inc., its affiliates, agents, and employees, and all persons acting on its or their behalf (collectively, "Vishay"), disclaim any and all liability for any errors, inaccuracies or incompleteness contained in any datasheet or in any other disclosure relating to any product.

Vishay makes no warranty, representation or guarantee regarding the suitability of the products for any particular purpose or the continuing production of any product. To the maximum extent permitted by applicable law, Vishay disclaims (i) any and all liability arising out of the application or use of any product, (ii) any and all liability, including without limitation special, consequential or incidental damages, and (iii) any and all implied warranties, including warranties of fitness for particular purpose, non-infringement and merchantability.

Statements regarding the suitability of products for certain types of applications are based on Vishay's knowledge of typical requirements that are often placed on Vishay products in generic applications. Such statements are not binding statements about the suitability of products for a particular application. It is the customer's responsibility to validate that a particular product with the properties described in the product specification is suitable for use in a particular application. Parameters provided in datasheets and / or specifications may vary in different applications and performance may vary over time. All operating parameters, including typical parameters, must be validated for each customer application by the customer's technical experts. Product specifications do not expand or otherwise modify Vishay's terms and conditions of purchase, including but not limited to the warranty expressed therein.

Except as expressly indicated in writing, Vishay products are not designed for use in medical, life-saving, or life-sustaining applications or for any other application in which the failure of the Vishay product could result in personal injury or death. Customers using or selling Vishay products not expressly indicated for use in such applications do so at their own risk. Please contact authorized Vishay personnel to obtain written terms and conditions regarding products designed for such applications.

No license, express or implied, by estoppel or otherwise, to any intellectual property rights is granted by this document or by any conduct of Vishay. Product names and markings noted herein may be trademarks of their respective owners.