

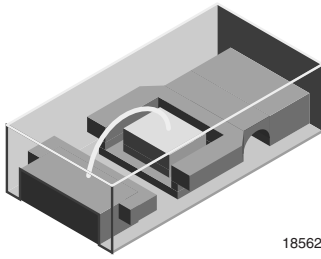

Standard 0603 SMD LED



18562

DESCRIPTION

The new 0603 LED series have been designed in the smallest SMD package. This innovative 0603 LED technology opens the way to

- smaller products of higher performance
- more design in flexibility
- enhanced applications

The 0603 LED is an obvious solution for small-scale, high power products that are expected to work reliability in an arduous environment.

PRODUCT GROUP AND PACKAGE DATA

- Product group: LED
- Package: SMD 0603
- Product series: standard
- Angle of half intensity: $\pm 80^\circ$

FEATURES

- Smallest SMD package 0603 with exceptional brightness
1.6 mm x 0.8 mm x 0.6 mm (L x W x H)
- High reliability lead frame based
- Temperature range -40 °C to +100 °C
- Footprint compatible to 0603 chipled
- Wavelength 570 nm (green), 561 nm (pure green), 589 nm (yellow), 606 nm (orange), 633 nm (red)
- AllnGaP and GaN technology
- Viewing angle: extremely wide 160°
- Grouping parameter: luminous intensity, wavelength
- Available in 8 mm tape
- Compatible to IR reflow soldering
- Preconditioning according to JEDEC® level 2
- AEC-Q101 qualified
- Material categorization: for definitions of compliance please see www.vishay.com/doc?99912

AUTOMOTIVE GRADE



RoHS COMPLIANT
HALOGEN FREE
GREEN (5-2008)

APPLICATIONS

- Backlight keypads
- Navigation systems
- Cellular phone displays
- Displays for industrial control systems
- Automotive features
- Miniaturized color effects
- Traffic displays

| PARTS TABLE | | | | | | | | | | | | | | |
|---------------|------------|--------------------------|------|------|------------------------|-----------------|------|------|------------------------|---------------------|------|------|------------------------|------------|
| PART | COLOR | LUMINOUS INTENSITY (mcd) | | | at I _F (mA) | WAVELENGTH (nm) | | | at I _F (mA) | FORWARD VOLTAGE (V) | | | at I _F (mA) | TECHNOLOGY |
| | | MIN. | TYP. | MAX. | | MIN. | TYP. | MAX. | | MIN. | TYP. | MAX. | | |
| TLMS1100-GS08 | Red | 32 | 63 | - | 20 | 627 | 633 | 639 | 20 | - | 2.1 | 2.4 | 20 | AllnGaP |
| TLMO1100-GS08 | Orange | 50 | 80 | - | 20 | 600 | 606 | 9 | 20 | - | 2.1 | 2.4 | 20 | AllnGaP |
| TLMY1100-GS08 | Yellow | 50 | 80 | - | 20 | 580 | 589 | 595 | 20 | - | 2.1 | 2.4 | 20 | AllnGaP |
| TLMG1100-GS08 | Green | 12.5 | 35 | - | 20 | 564 | 570 | 575 | 20 | - | 2.1 | 2.4 | 20 | AllnGaP |
| TLMP1100-GS08 | Pure green | 6.3 | 15 | - | 20 | 551 | 561 | 566 | 20 | - | 2.1 | 2.4 | 20 | AllnGaP |



| ABSOLUTE MAXIMUM RATINGS ($T_{amb} = 25\text{ }^{\circ}\text{C}$, unless otherwise specified) TLMS1100, TLMO1100, TLMY1100, TLMG1100, TLMP1100 | | | | |
|---|---|------------|-------------|--------------------|
| PARAMETER | TEST CONDITION | SYMBOL | VALUE | UNIT |
| Reverse voltage ⁽¹⁾ | | V_R | 12 | V |
| DC forward current | $T_{amb} \leq 75\text{ }^{\circ}\text{C}$ | I_F | 30 | mA |
| Surge forward current | $t_p \leq 10\text{ }\mu\text{s}$ | I_{FSM} | 0.5 | A |
| Power dissipation | | P_V | 90 | mW |
| Junction temperature | | T_j | +120 | $^{\circ}\text{C}$ |
| Operating temperature range | | T_{amb} | -40 to +100 | $^{\circ}\text{C}$ |
| Storage temperature range | | T_{stg} | -40 to +100 | $^{\circ}\text{C}$ |
| Soldering temperature | According to Vishay specification | T_{sd} | +260 | $^{\circ}\text{C}$ |
| Thermal resistance junction-to-ambient | Mounted on PC board (pad size > 5 mm ²) | R_{thJA} | 480 | K/W |

Note

⁽¹⁾ Driving the LED in reverse direction is suitable for short term application

| OPTICAL AND ELECTRICAL CHARACTERISTICS ($T_{amb} = 25\text{ }^{\circ}\text{C}$, unless otherwise specified) TLMS1100, RED | | | | | | |
|--|---|-------------|------|----------|------|------------|
| PARAMETER | TEST CONDITION | SYMBOL | MIN. | TYP. | MAX. | UNIT |
| Luminous intensity | $I_F = 20\text{ mA}$ | I_V | 32 | 63 | - | mcd |
| Dominant wavelength | $I_F = 20\text{ mA}$ | λ_d | 627 | 633 | 639 | nm |
| Peak wavelength | $I_F = 20\text{ mA}$ | λ_p | - | 645 | - | nm |
| Angle of half intensity | $I_F = 20\text{ mA}$ | ϕ | - | ± 80 | - | $^{\circ}$ |
| Forward voltage | $I_F = 20\text{ mA}$ | V_F | - | 2.1 | 2.4 | V |
| Reverse voltage | $I_R = 10\text{ }\mu\text{A}$ | V_R | 6 | - | - | V |
| Junction capacitance | $V_R = 0\text{ V}$, $f = 1\text{ MHz}$ | C_j | - | 15 | - | pF |

| OPTICAL AND ELECTRICAL CHARACTERISTICS ($T_{amb} = 25\text{ }^{\circ}\text{C}$, unless otherwise specified) TLMO1100, ORANGE | | | | | | |
|---|---|-------------|------|----------|------|------------|
| PARAMETER | TEST CONDITION | SYMBOL | MIN. | TYP. | MAX. | UNIT |
| Luminous intensity | $I_F = 20\text{ mA}$ | I_V | 50 | 80 | - | mcd |
| Dominant wavelength | $I_F = 20\text{ mA}$ | λ_d | 600 | 606 | 609 | nm |
| Peak wavelength | $I_F = 20\text{ mA}$ | λ_p | - | 610 | - | nm |
| Angle of half intensity | $I_F = 20\text{ mA}$ | ϕ | - | ± 80 | - | $^{\circ}$ |
| Forward voltage | $I_F = 20\text{ mA}$ | V_F | - | 2.1 | 2.4 | V |
| Reverse voltage | $I_R = 10\text{ }\mu\text{A}$ | V_R | 6 | - | - | V |
| Junction capacitance | $V_R = 0\text{ V}$, $f = 1\text{ MHz}$ | C_j | - | 15 | - | pF |

| OPTICAL AND ELECTRICAL CHARACTERISTICS ($T_{amb} = 25\text{ }^{\circ}\text{C}$, unless otherwise specified) TLMY1100, YELLOW | | | | | | |
|---|---|-------------|------|----------|------|------------|
| PARAMETER | TEST CONDITION | SYMBOL | MIN. | TYP. | MAX. | UNIT |
| Luminous intensity | $I_F = 20\text{ mA}$ | I_V | 50 | 80 | - | mcd |
| Dominant wavelength | $I_F = 20\text{ mA}$ | λ_d | 580 | 589 | 595 | nm |
| Peak wavelength | $I_F = 20\text{ mA}$ | λ_p | - | 591 | - | nm |
| Angle of half intensity | $I_F = 20\text{ mA}$ | ϕ | - | ± 80 | - | $^{\circ}$ |
| Forward voltage | $I_F = 20\text{ mA}$ | V_F | - | 2.1 | 2.4 | V |
| Reverse voltage | $I_R = 10\text{ }\mu\text{A}$ | V_R | 6 | - | - | V |
| Junction capacitance | $V_R = 0\text{ V}$, $f = 1\text{ MHz}$ | C_j | - | 15 | - | pF |



| OPTICAL AND ELECTRICAL CHARACTERISTICS ($T_{amb} = 25\text{ }^{\circ}\text{C}$, unless otherwise specified) | | | | | | |
|--|---|-------------|------|----------|------|------------|
| TLMG1100, GREEN | | | | | | |
| PARAMETER | TEST CONDITION | SYMBOL | MIN. | TYP. | MAX. | UNIT |
| Luminous intensity | $I_F = 20\text{ mA}$ | I_V | 12.5 | 35 | - | mcd |
| Dominant wavelength | $I_F = 20\text{ mA}$ | λ_d | 564 | 570 | 575 | nm |
| Peak wavelength | $I_F = 20\text{ mA}$ | λ_p | - | 572 | - | nm |
| Angle of half intensity | $I_F = 20\text{ mA}$ | ϕ | - | ± 80 | - | $^{\circ}$ |
| Forward voltage | $I_F = 20\text{ mA}$ | V_F | - | 2.1 | 2.4 | V |
| Reverse voltage | $I_R = 10\text{ }\mu\text{A}$ | V_R | 6 | - | - | V |
| Junction capacitance | $V_R = 0\text{ V}$, $f = 1\text{ MHz}$ | C_j | - | 15 | - | pF |

| OPTICAL AND ELECTRICAL CHARACTERISTICS ($T_{amb} = 25\text{ }^{\circ}\text{C}$, unless otherwise specified) | | | | | | |
|--|---|-------------|------|----------|------|------------|
| TLMP1100, PURE GREEN | | | | | | |
| PARAMETER | TEST CONDITION | SYMBOL | MIN. | TYP. | MAX. | UNIT |
| Luminous intensity | $I_F = 20\text{ mA}$ | I_V | 6.3 | 15 | - | mcd |
| Dominant wavelength | $I_F = 20\text{ mA}$ | λ_d | 551 | 561 | 566 | nm |
| Peak wavelength | $I_F = 20\text{ mA}$ | λ_p | - | 562 | - | nm |
| Angle of half intensity | $I_F = 20\text{ mA}$ | ϕ | - | ± 80 | - | $^{\circ}$ |
| Forward voltage | $I_F = 20\text{ mA}$ | V_F | - | 2.1 | 2.4 | V |
| Reverse voltage | $I_R = 10\text{ }\mu\text{A}$ | V_R | 6 | - | - | V |
| Junction capacitance | $V_R = 0\text{ V}$, $f = 1\text{ MHz}$ | C_j | - | 15 | - | pF |

| LUMINOUS INTENSITY/FLUX CLASSIFICATION | | |
|---|--------------------------------|------|
| GROUP | LUMINOUS INTENSITY I_V (mcd) | |
| | MIN. | MAX. |
| Pa | 4 | 6.3 |
| Pb | 5 | 8 |
| Qa | 6.3 | 10 |
| Qb | 8 | 12.5 |
| Ra | 10 | 16 |
| Rb | 12.5 | 20 |
| Sa | 16 | 25 |
| Sb | 20 | 32 |
| Ta | 25 | 40 |
| Tb | 32 | 50 |
| Ua | 40 | 63 |
| Ub | 50 | 80 |
| Va | 63 | 100 |
| Vb | 80 | 125 |
| Wa | 100 | 160 |
| Wb | 125 | 200 |

Note

- Luminous intensity is tested at a current pulse duration of 25 ms.
The above type numbers represent the order groups which include only a few brightness groups. Only one group will be shipped on each reel (there will be no mixing of two groups on each reel).
In order to ensure availability, single brightness groups will not be orderable.
In a similar manner for colors where wavelength groups are measured and binned, single wavelength groups will be shipped in any one reel.
In order to ensure availability, single wavelength groups will not be orderable



| COLOR CLASSIFICATION | | | | | | | | |
|----------------------|----------------------|------|-------|------|--------|------|--------|------|
| GROUP | DOM. WAVELENGTH (nm) | | | | | | | |
| | PURE GREEN | | GREEN | | YELLOW | | ORANGE | |
| | MIN. | MAX. | MIN. | MAX. | MIN. | MAX. | MIN. | MAX. |
| 1 | 551 | 554 | 564 | 566 | - | - | - | - |
| 2 | 554 | 557 | 566 | 569 | 580 | 583 | 600 | 603 |
| 3 | 557 | 560 | 569 | 572 | 583 | 586 | 603 | 606 |
| 4 | 560 | 563 | 572 | 575 | 586 | 589 | 606 | 609 |
| 5 | 563 | 566 | - | - | 589 | 592 | 609 | 612 |
| 6 | - | - | - | - | 592 | 595 | - | - |

Note

- Wavelengths are tested at a current pulse duration of 25 ms and an accuracy of ± 1 nm

| GROUP NAME ON LABEL | | |
|--------------------------|-----------|------------|
| LUMINOUS INTENSITY GROUP | HALFGROUP | WAVELENGTH |
| Q | b | 4 |

Note

- One packing unit/tape contains only one classification group of luminous intensity, color and forward voltage. Only one single classification groups is not available. The given groups are not order codes, customer specific group combinations require marketing agreement. No color subgrouping for super red

TYPICAL CHARACTERISTICS ($T_{amb} = 25\text{ }^\circ\text{C}$, unless otherwise specified)

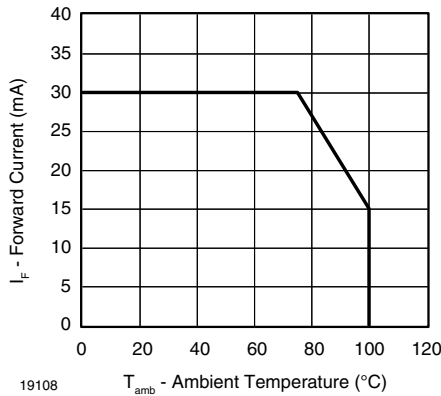

Fig. 1 - Forward Current vs. Ambient Temperature

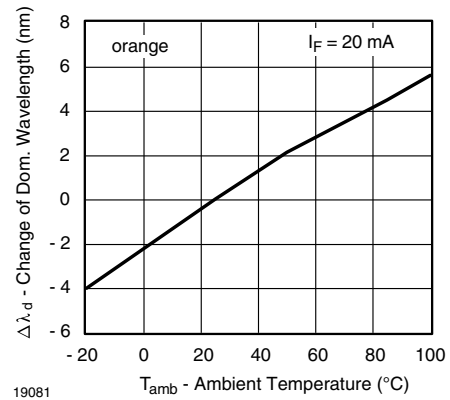

Fig. 2 - Change of Dominant Wavelength vs. Ambient Temperature

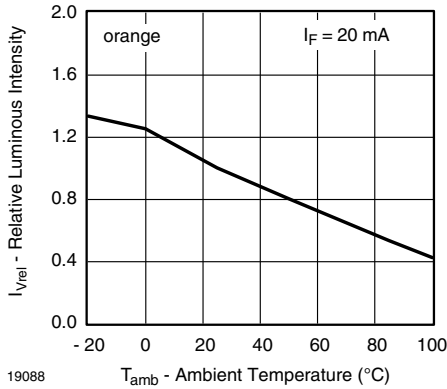

Fig. 3 - Relative Luminous Intensity vs. Ambient Temperature

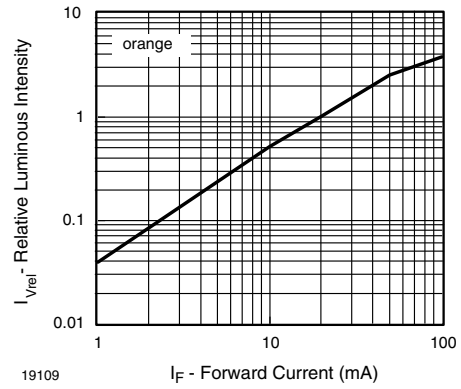

Fig. 6 - Relative Luminous Intensity vs. Forward Current

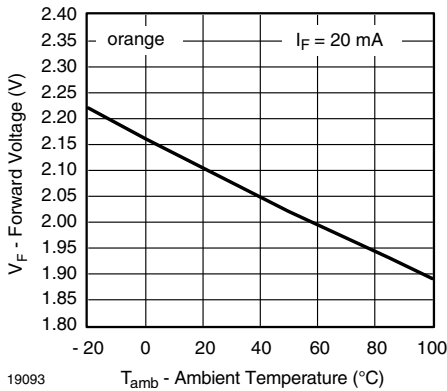

Fig. 4 - Forward Voltage vs. Ambient Temperature

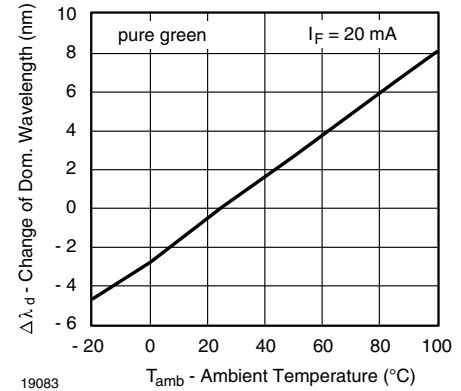

Fig. 7 - Change of Dominant Wavelength vs. Ambient Temperature

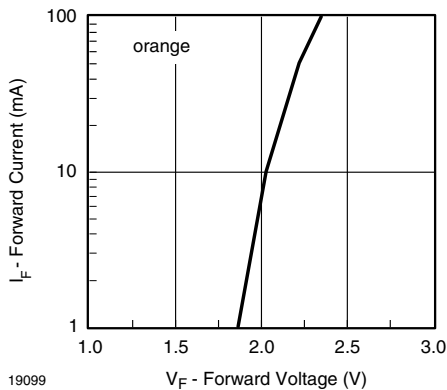

Fig. 5 - Forward Current vs. Forward Voltage

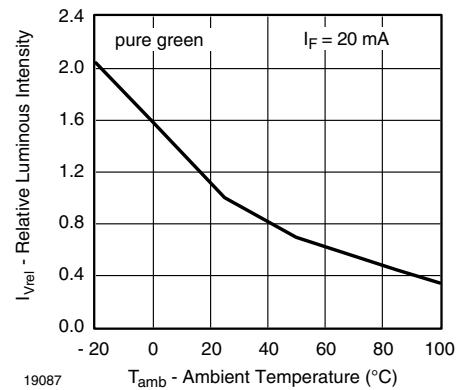

Fig. 8 - Relative Luminous Intensity vs. Ambient Temperature

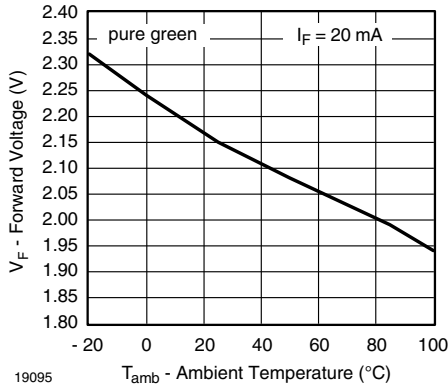

Fig. 9 - Forward Voltage vs. Ambient Temperature

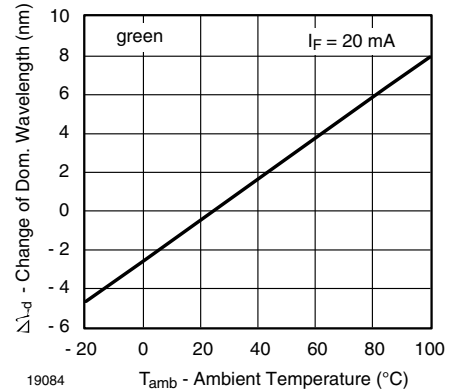

Fig. 12 - Change of Dominant Wavelength vs. Ambient Temperature

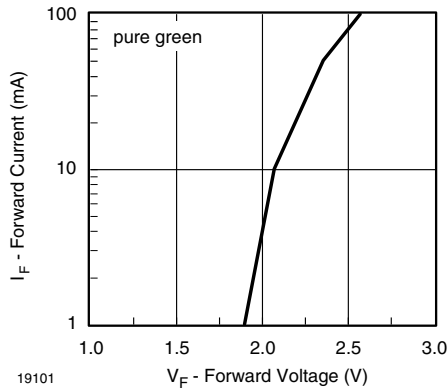

Fig. 10 - Forward Current vs. Forward Voltage

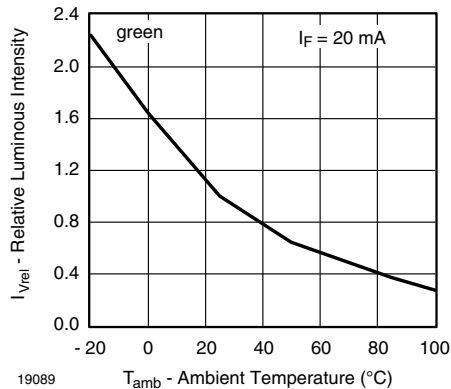

Fig. 13 - Relative Luminous Intensity vs. Ambient Temperature

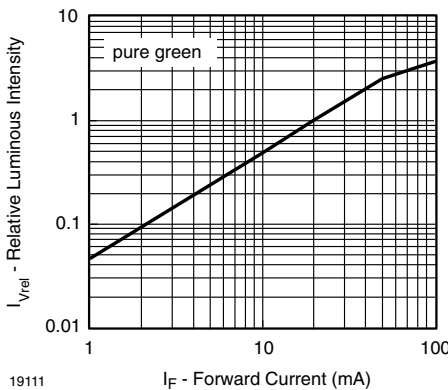

Fig. 11 - Relative Luminous Intensity vs. Forward Current

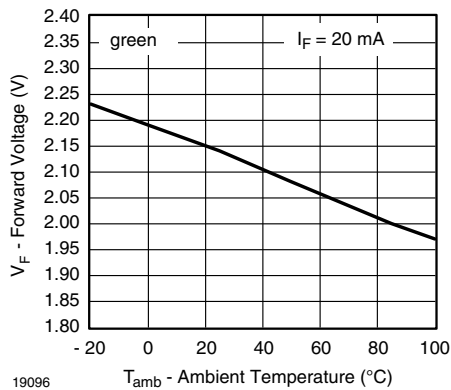

Fig. 14 - Forward Voltage vs. Ambient Temperature

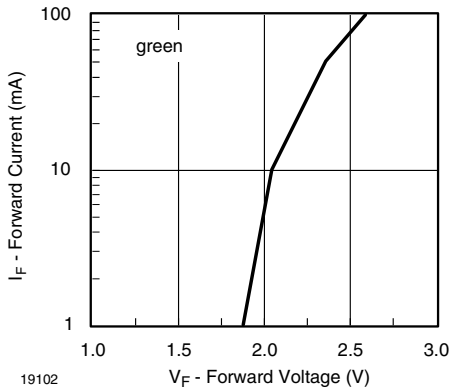

Fig. 15 - Forward Current vs. Forward Voltage

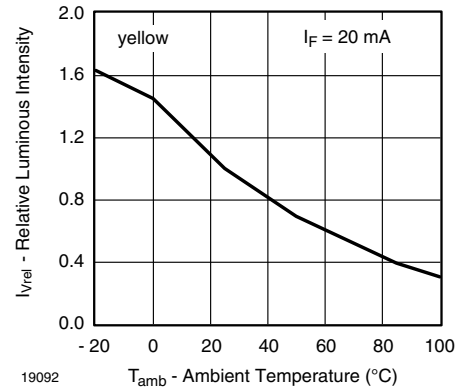

Fig. 18 - Relative Luminous Intensity vs. Ambient Temperature

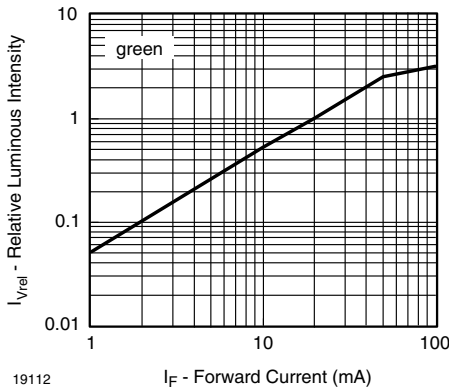

Fig. 16 - Relative Luminous Intensity vs. Forward Current

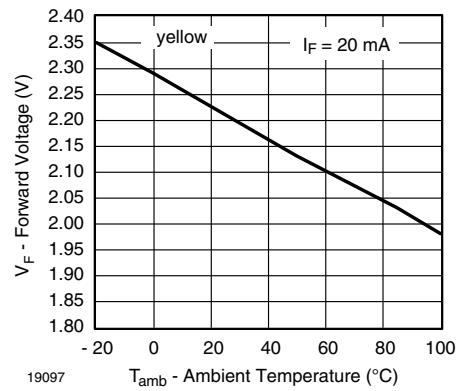

Fig. 19 - Forward Voltage vs. Ambient Temperature

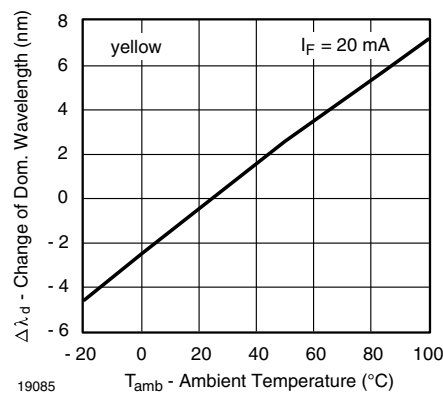

Fig. 17 - Change of Dominant Wavelength vs. Ambient Temperature

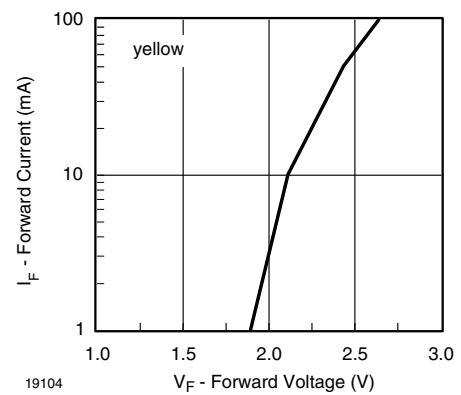

Fig. 20 - Forward Current vs. Forward Voltage

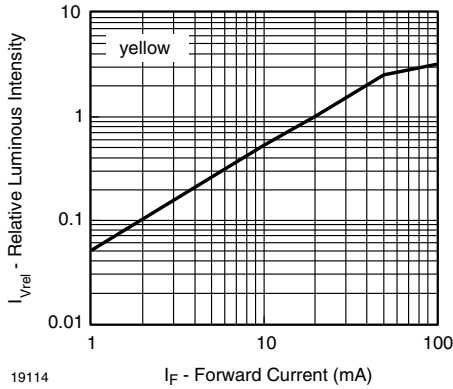

Fig. 21 - Relative Luminous Intensity vs. Forward Current

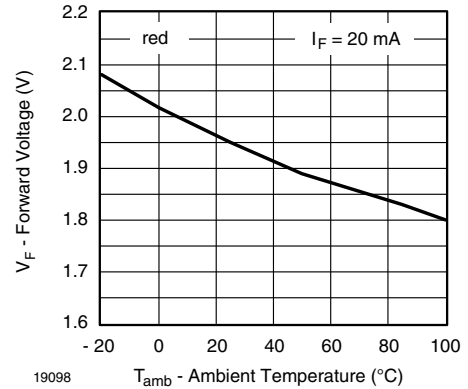

Fig. 24 - Forward Voltage vs. Ambient Temperature

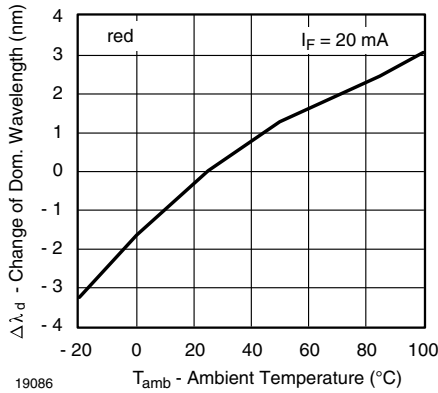

Fig. 22 - Change of Dominant Wavelength vs. Ambient Temperature

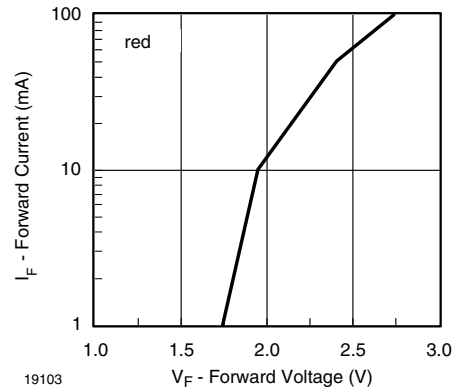

Fig. 25 - Forward Current vs. Forward Voltage

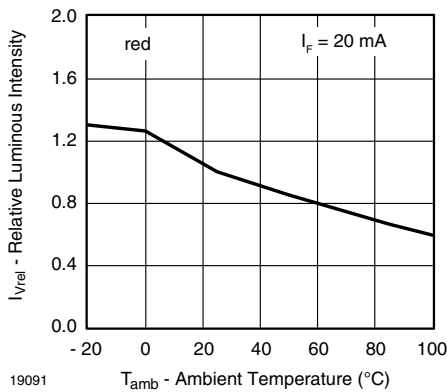

Fig. 23 - Relative Luminous Intensity vs. Ambient Temperature

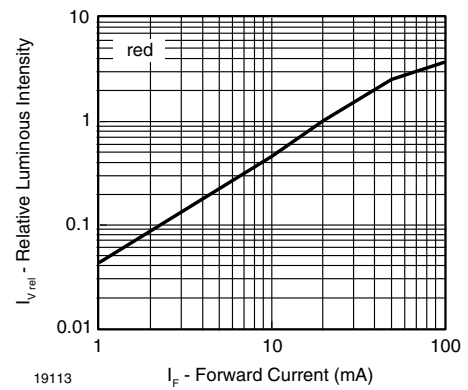
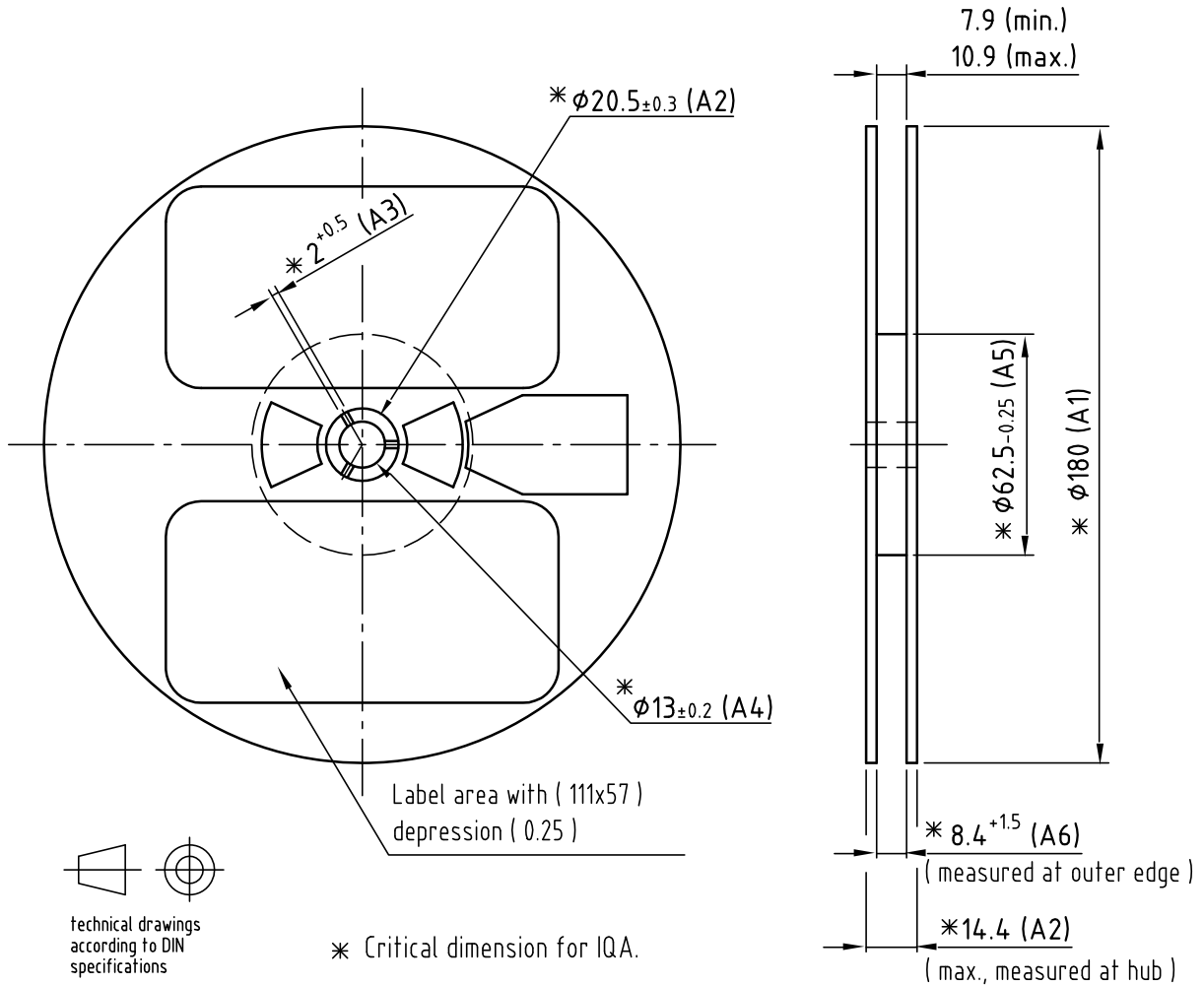

Fig. 26 - Relative Luminous Intensity vs. Forward Current



REEL DIMENSIONS in millimeters



Drawing-No.: 9.800-5086.01-4
Issue: 1; 29.04.04

19043

Not indicated tolerances ± 0.05
Material: black static dissipative
MOQ: 3000 pcs on one reel
(MOQ = minimum order quantity)



TAPE DIMENSIONS in millimeters

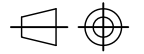
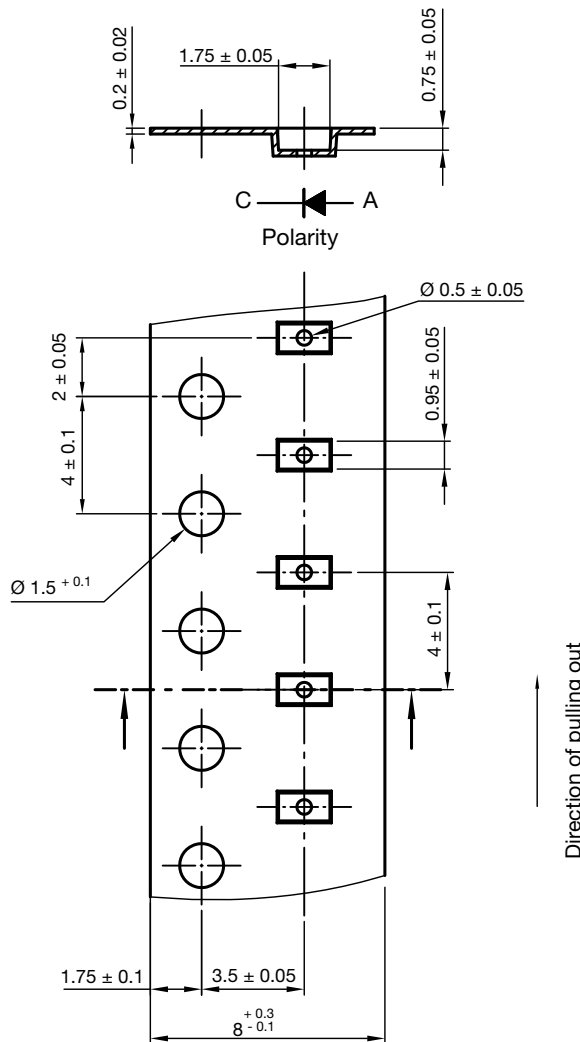

Technical drawings according to DIN specifications

Not indicated tolerances ± 0.05
Material: Conductive black PC

Drawing-No.: 9.700-5290.01-4
Issue: 3; 24.09.13



PACKAGE DIMENSIONS in millimeters

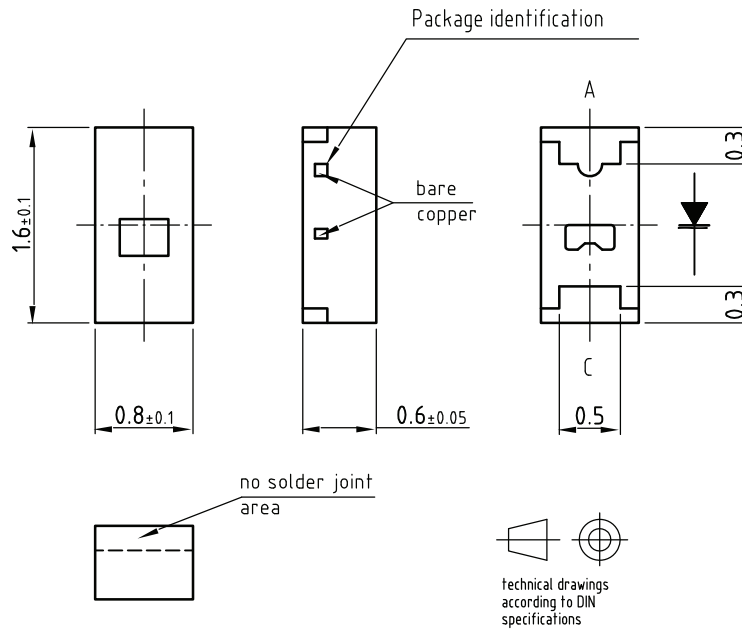

Not indicated tolerances ± 0.1

Recommended solder pad

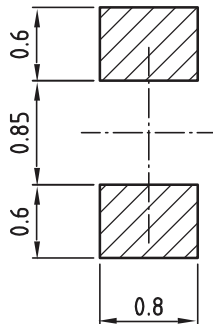

Drawing-No.: 6.541-5056.01-4

Issue: 2; 04.05.05

19426



SOLDERING PROFILE

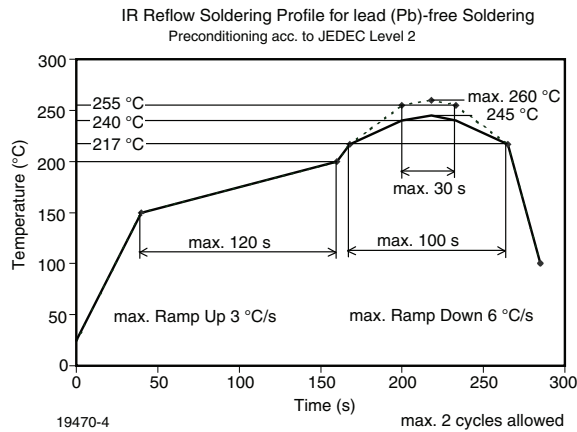
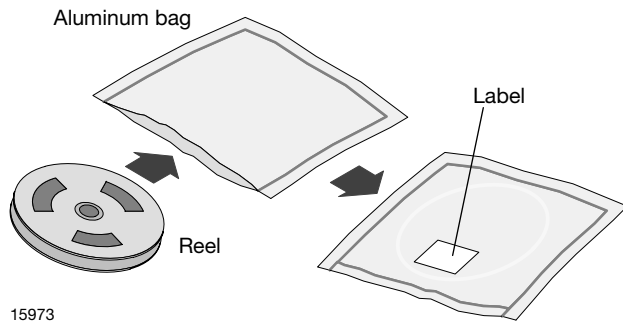

Fig. 27 - Vishay Lead (Pb)-free Reflow Soldering Profile (acc. to J-STD-020C)

DRY PACKING

The reel is packed in an anti-humidity bag to protect the devices from absorbing moisture during transportation and storage.



FINAL PACKING

The sealed reel is packed into a cardboard box. A secondary cardboard box is used for shipping purposes.

HANDLING REMARK

Since a ChipLED is very tiny and light, it can become more vulnerable to sticking on the cover tape during the assembly process. Therefore it is highly recommended to consider precautionary actions addressing the triboelectric effect as described in the application note: "How to Avoid ChipLEDs Sticking to Cover Tape During Automated Tape-and-Reel Assembly" (www.vishay.com/doc?84998).

RECOMMENDED METHOD OF STORAGE

Dry box storage is recommended as soon as the aluminum bag has been opened to prevent moisture absorption. The following conditions should be observed, if dry boxes are not available:

- Storage temperature 10 °C to 30 °C
- Storage humidity ≤ 60 % RH max.

After more than 1 year under these conditions moisture content will be too high for reflow soldering.

In case of moisture absorption, the devices will recover to the former condition by drying under the following condition: 192 h at 40 °C + 5 °C / - 0 °C and < 5 % RH (dry air / nitrogen) or

96 h at 60 °C + 5 °C and < 5 % RH for all device containers or

24 h at 100 °C + 5 °C not suitable for reel or tubes.

An EIA JEDEC standard JESD22-A112 level 2 label is included on all dry bags.

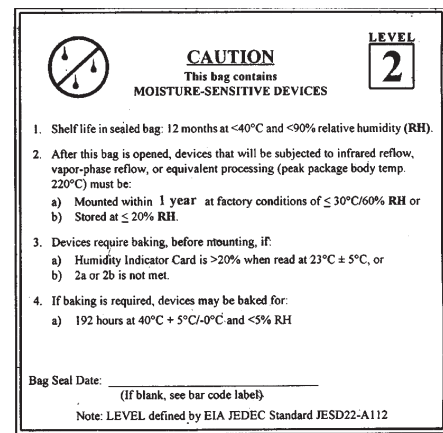

Example of JESD22-A112 level 2 label

ESD PRECAUTION

Proper storage and handling procedures should be followed to prevent ESD damage to the devices especially when they are removed from the antistatic shielding bag. Electrostatic sensitive devices warning labels are on the packaging.

VISHAY SEMICONDUCTORS STANDARD BAR CODE LABELS

The Vishay Semiconductors standard bar code labels are printed at final packing areas. The labels are on each packing unit and contain Vishay Semiconductors specific data.



Disclaimer

ALL PRODUCT, PRODUCT SPECIFICATIONS AND DATA ARE SUBJECT TO CHANGE WITHOUT NOTICE TO IMPROVE RELIABILITY, FUNCTION OR DESIGN OR OTHERWISE.

Vishay Intertechnology, Inc., its affiliates, agents, and employees, and all persons acting on its or their behalf (collectively, "Vishay"), disclaim any and all liability for any errors, inaccuracies or incompleteness contained in any datasheet or in any other disclosure relating to any product.

Vishay makes no warranty, representation or guarantee regarding the suitability of the products for any particular purpose or the continuing production of any product. To the maximum extent permitted by applicable law, Vishay disclaims (i) any and all liability arising out of the application or use of any product, (ii) any and all liability, including without limitation special, consequential or incidental damages, and (iii) any and all implied warranties, including warranties of fitness for particular purpose, non-infringement and merchantability.

Statements regarding the suitability of products for certain types of applications are based on Vishay's knowledge of typical requirements that are often placed on Vishay products in generic applications. Such statements are not binding statements about the suitability of products for a particular application. It is the customer's responsibility to validate that a particular product with the properties described in the product specification is suitable for use in a particular application. Parameters provided in datasheets and / or specifications may vary in different applications and performance may vary over time. All operating parameters, including typical parameters, must be validated for each customer application by the customer's technical experts. Product specifications do not expand or otherwise modify Vishay's terms and conditions of purchase, including but not limited to the warranty expressed therein.

Hyperlinks included in this datasheet may direct users to third-party websites. These links are provided as a convenience and for informational purposes only. Inclusion of these hyperlinks does not constitute an endorsement or an approval by Vishay of any of the products, services or opinions of the corporation, organization or individual associated with the third-party website. Vishay disclaims any and all liability and bears no responsibility for the accuracy, legality or content of the third-party website or for that of subsequent links.

Except as expressly indicated in writing, Vishay products are not designed for use in medical, life-saving, or life-sustaining applications or for any other application in which the failure of the Vishay product could result in personal injury or death. Customers using or selling Vishay products not expressly indicated for use in such applications do so at their own risk. Please contact authorized Vishay personnel to obtain written terms and conditions regarding products designed for such applications.

No license, express or implied, by estoppel or otherwise, to any intellectual property rights is granted by this document or by any conduct of Vishay. Product names and markings noted herein may be trademarks of their respective owners.