

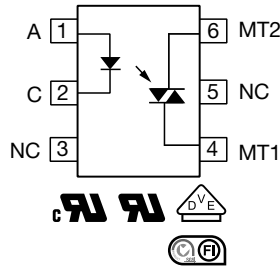

Optocoupler, Phototriac Output, High dV/dt, Low Input Current



23128



FEATURES

- Low trigger current $I_{FT} = 0.7 \text{ mA}$ (typ.)
- $I_{TRMS} = 300 \text{ mA}$
- High static $dV/dt \geq 10\,000 \text{ V}/\mu\text{s}$
- Load voltage up to 800 V
- Material categorization: for definitions of compliance please see www.vishay.com/doc?99912



RoHS COMPLIANT

LINKS TO ADDITIONAL RESOURCES



3D Models



Design Tools



Related Documents



SPICE Models



Footprints



Schematics

DESCRIPTION

The IL4216, IL4217, and IL4218 product family consists of an optically coupled GaAs IRLED to a photosensitive thyristor system with integrated noise suppression circuit.

The thyristor system enables low trigger currents of 0.7 mA and features a dV/dt ratio of greater than 10 kV/ μs and load voltages up to 800 V.

The IL4216, IL4217, and IL4218 product family is a perfect microcontroller friendly solution to isolate low voltage logic from high voltage 120 V_{AC}, 240 V_{AC}, and 380 V_{AC} lines and to control resistive, inductive, or capacitive AC loads like motors, solenoids, high power thyristors or TRIACs, and solid-state relays.

APPLICATIONS

- Solid-state relay
- Lighting controls
- Temperature controls
- Solenoid / valve controls
- AC motor drives / starters

AGENCY APPROVALS

- [UL](#)
- [cUL](#)
- [DIN EN 60747-5-5 \(VDE 0884-5\)](#) available with option 1
- [FIMKO](#)

ORDERING INFORMATION																											
<table border="1" style="margin: auto;"> <tr> <td style="padding: 2px 5px;">I</td> <td style="padding: 2px 5px;">L</td> <td style="padding: 2px 5px;">4</td> <td style="padding: 2px 5px;">2</td> <td style="padding: 2px 5px;">1</td> <td style="padding: 2px 5px;">#</td> <td style="padding: 2px 5px;">-</td> <td style="padding: 2px 5px;">X</td> <td style="padding: 2px 5px;">0</td> <td style="padding: 2px 5px;">#</td> <td style="padding: 2px 5px;">#</td> <td style="padding: 2px 5px;">T</td> </tr> <tr> <td colspan="6" style="text-align: center;">PART NUMBER</td> <td></td> <td colspan="3" style="text-align: center;">PACKAGE OPTION</td> <td colspan="2" style="text-align: center;">TAPE AND REEL</td> </tr> </table>	I	L	4	2	1	#	-	X	0	#	#	T	PART NUMBER							PACKAGE OPTION			TAPE AND REEL				
I	L	4	2	1	#	-	X	0	#	#	T																
PART NUMBER							PACKAGE OPTION			TAPE AND REEL																	
AGENCY CERTIFIED / PACKAGE	BLOCKING VOLTAGE V_{DRM} (V)																										
UL, cUL, FIMKO	600	700	800																								
DIP-6	IL4216	IL4217	IL4218																								
DIP-6, 400 mil, option 6	-	-	IL4218-X006																								
SMD-6, option 7	IL4216-X007T	-	-																								
UL, cUL, FIMKO, VDE (Option 1)	600	700	800																								
DIP-6	IL4216-X001	-	IL4218-X001																								
DIP-6, 400 mil, option 6	IL4216-X016	-	-																								
SMD-6, option 7	-	-	IL4218-X017T ⁽¹⁾																								
SMD-6, option 9	-	-	IL4218-X019T ⁽¹⁾																								

Note

⁽¹⁾ Also available in tubes, do not put T on the end



ABSOLUTE MAXIMUM RATINGS (T _{amb} = 25 °C, unless otherwise specified)					
PARAMETER	TEST CONDITION	PART	SYMBOL	VALUE	UNIT
INPUT					
Reverse voltage			V _R	6	V
Forward current			I _F	60	mA
Surge current			I _{FSM}	2.5	A
Power dissipation			P _{diss}	100	mW
Derate linearly from 25 °C				1.33	mW/°C
Thermal resistance			R _{th}	750	°C/W
OUTPUT					
Peak off-state voltage		IL4216	V _{DRM}	600	V
		IL4217	V _{DRM}	700	V
		IL4218	V _{DRM}	800	V
RMS on-state current			I _{DRM}	300	mA
Single cycle surge			I _{TSM}	3	A
Power dissipation			P _{diss}	300	mW
Derate linearly from 25 °C				6.6	mW/°C
Thermal resistance			R _{th}	150	°C/W
COUPLER					
Storage temperature			T _{stg}	-55 to +150	°C
Ambient temperature			T _{amb}	-55 to +100	°C
Lead soldering temperature ⁽¹⁾	5 s		T _{slid}	260	°C

Notes

- Stresses in excess of the absolute maximum ratings can cause permanent damage to the device. Functional operation of the device is not implied at these or any other conditions in excess of those given in the operational sections of this document. Exposure to absolute maximum ratings for extended periods of the time can adversely affect reliability
- ⁽¹⁾ Refer to reflow profile for soldering conditions for surface mounted devices (SMD). Refer to wave profile for soldering conditions for through hole devices (DIP)

ELECTRICAL CHARACTERISTICS (T _{amb} = 25 °C, unless otherwise specified)							
PARAMETER	TEST CONDITION	PART	SYMBOL	MIN.	TYP.	MAX.	UNIT
INPUT							
Forward voltage	I _F = 20 mA		V _F	-	1.3	1.5	V
Breakdown voltage	I _R = 10 μA		V _{BR}	6	30	-	V
Reverse current	V _R = 6 V		I _R	-	0.1	10	μA
Input capacitance	V _F = 0 V, f = 1 MHz		C _{IN}	-	40	-	pF
Thermal resistance, junction to lead			R _{thjl}	-	750	-	°C/W
OUTPUT							
Repetitive peak off-state voltage	I _{DRM} = 100 μA	IL4216	V _{DRM}	600	650	-	V
		IL4217	V _{DRM}	700	750	-	V
		IL4218	V _{DRM}	800	850	-	V
Off-state voltage	I _{D(RMS)} = 70 μA	IL4216	V _{D(RMS)}	424	460	-	V
		IL4217	V _{D(RMS)}	484	536	-	V
		IL4218	V _{D(RMS)}	565	613	-	V
Off-state current	V _D = 600 V, T _{amb} = 100 °C		I _{D(RMS)}	-	10	100	μA
Reverse current	V _R = 600 V, T _{amb} = 25 °C		I _{RMS}	-	10	100	μA
On-state voltage	I _T = 300 mA		V _{TM}	-	1.7	3	V
On-state current	PF = 1, V _{T(RMS)} = 1.7 V		I _{TM}	-	-	300	mA
Surge (non-repetitive, on-state current)	f = 50 Hz		I _{TSM}	-	-	3	A
Holding current	V _T = 3 V		I _H	-	65	200	μA
Latching current	V _T = 2.2 V		I _L	-	-	500	μA
LED trigger current	V _{AK} = 5 V		I _{FT}	-	0.7	-	mA



ELECTRICAL CHARACTERISTICS (T _{amb} = 25 °C, unless otherwise specified)							
PARAMETER	TEST CONDITION	PART	SYMBOL	MIN.	TYP.	MAX.	UNIT
OUTPUT							
Critical rate of rise of off-state voltage	V _D = 0.67 V _{DRM} , T _{amb} = 25 °C		dV/dt _{cr}	10 000	-	-	V/μs
	V _D = 0.67 V _{DRM} , T _{amb} = 80 °C		dV/dt _{cr}	5000	-	-	V/μs
Critical rate of rise of voltage at current commutation	V _D = 230 V _{RMS} , I _D = 300 mA _{RMS} , T _J = 25 °C		dV/dt _{crq}	-	8	-	V/μs
	V _D = 230 V _{RMS} , I _D = 300 mA _{RMS} , T _J = 85 °C		dV/dt _{crq}	-	7	-	V/μs
Critical rate of rise of on-state current commutation	V _D = 230 V _{RMS} , I _D = 300 mA _{RMS} , T _J = 25 °C		dI/dt _{crq}	-	12	-	A/ms
Thermal resistance, junction to lead			R _{thjl}	-	150	-	°C/W
COUPLER							
Capacitance (input to output)	f = 1 MHz, V _{IO} = 0 V		C _{IO}	-	0.8	-	pF
Critical rate of rise of coupled input to output voltage	I _T = 0, V _{RM} = V _{DM} = 300 V _{AC}		dV _(IO) /dt	5000	1	-	mA

Note

- Minimum and maximum values are testing requirements. Typical values are characteristics of the device and are the result of engineering evaluation. Typical values are for information only and are not part of the testing requirements

POWER FACTOR CONSIDERATIONS

A snubber is not needed to eliminate false operation of the TRIAC driver because of the IL4216, IL4217, IL4218 high static and commutating dV/dt with loads between 1 and 0.8 power factors. When inductive loads with power factors less than 0.8 are being driven, include a RC snubber or a single capacitor directly across the device to damp the peak commutating dV/dt spike. Normally a commutating dV/dt causes a turning-off device to stay on due to the stored energy remaining in the turning-off device.

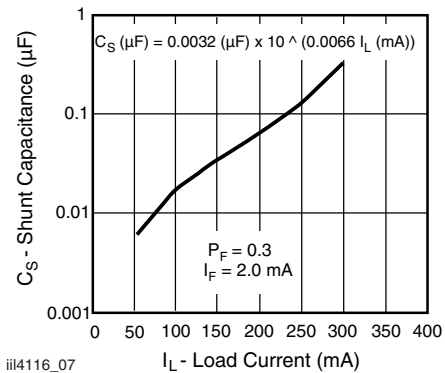

Fig. 1 - Shunt Capacitance vs. Load Current vs. Power Factor

SAFETY AND INSULATION RATINGS				
PARAMETER	TEST CONDITION	SYMBOL	VALUE	UNIT
Climatic classification	According to IEC 68 part 1		55 / 100 / 21	
Comparative tracking index		CTI	175	
Maximum rated withstanding isolation voltage	t = 1 min	V _{ISO}	4420	V _{RMS}
Maximum transient isolation voltage		V _{IOTM}	8000	V _{peak}
Maximum repetitive peak isolation voltage		V _{IORM}	890	V _{peak}
Isolation resistance	V _{IO} = 500 V, T _{amb} = 25 °C	R _{IO}	≥ 10 ¹²	Ω
	V _{IO} = 500 V, T _{amb} = 100 °C	R _{IO}	≥ 10 ¹¹	Ω
Output safety power		P _{SO}	500	mW
Input safety current		I _{SI}	250	mA
Safety temperature		T _S	175	°C
Creepage distance	DIP-6; SMD-6, option 7; SMD-6, option 9		≥ 7	mm
	DIP-6, 400 mil, option 6		≥ 8	mm
Clearance distance	DIP-6; SMD-6, option 7; SMD-6, option 9		≥ 7	mm
	DIP-6, 400 mil, option 6		≥ 8	mm
Insulation thickness		DTI	≥ 0.4	mm

Note

- As per IEC 60747-5-5, § 7.4.3.8.2, this optocoupler is suitable for “safe electrical insulation” only within the safety ratings. Compliance with the safety ratings shall be ensured by means of protective circuits

TYPICAL CHARACTERISTICS ($T_{amb} = 25\text{ }^{\circ}\text{C}$, unless otherwise specified)

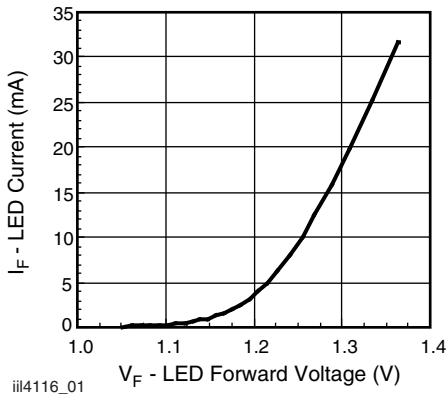

Fig. 2 - LED Forward Current vs. Forward Voltage

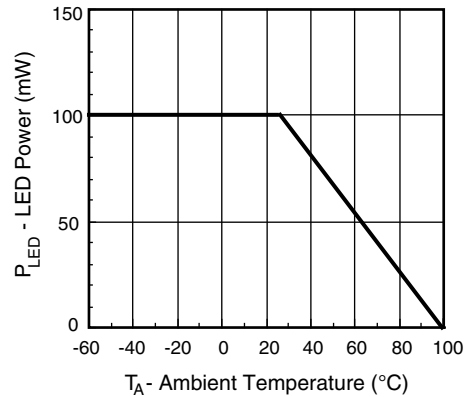

Fig. 5 - Maximum LED Power Dissipation

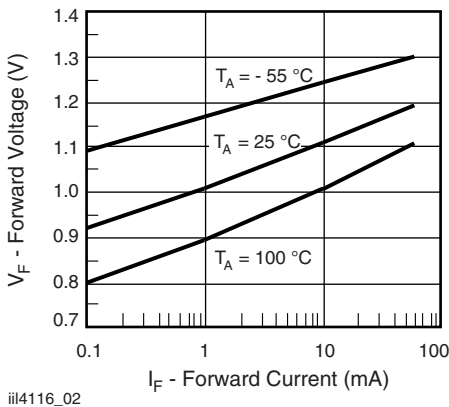

Fig. 3 - Forward Voltage vs. Forward Current

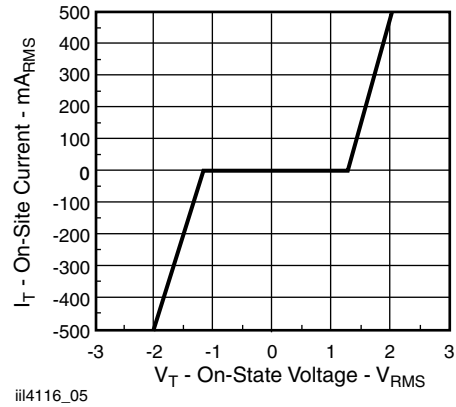

Fig. 6 - On-State Terminal Voltage vs. Terminal Current

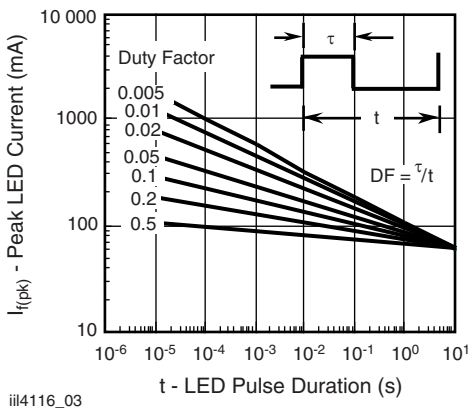

Fig. 4 - Peak LED Current vs. Duty Factor, τ

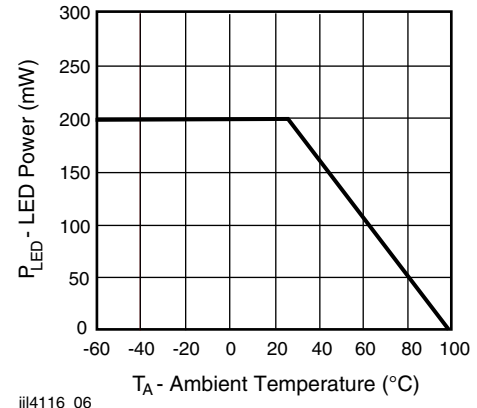
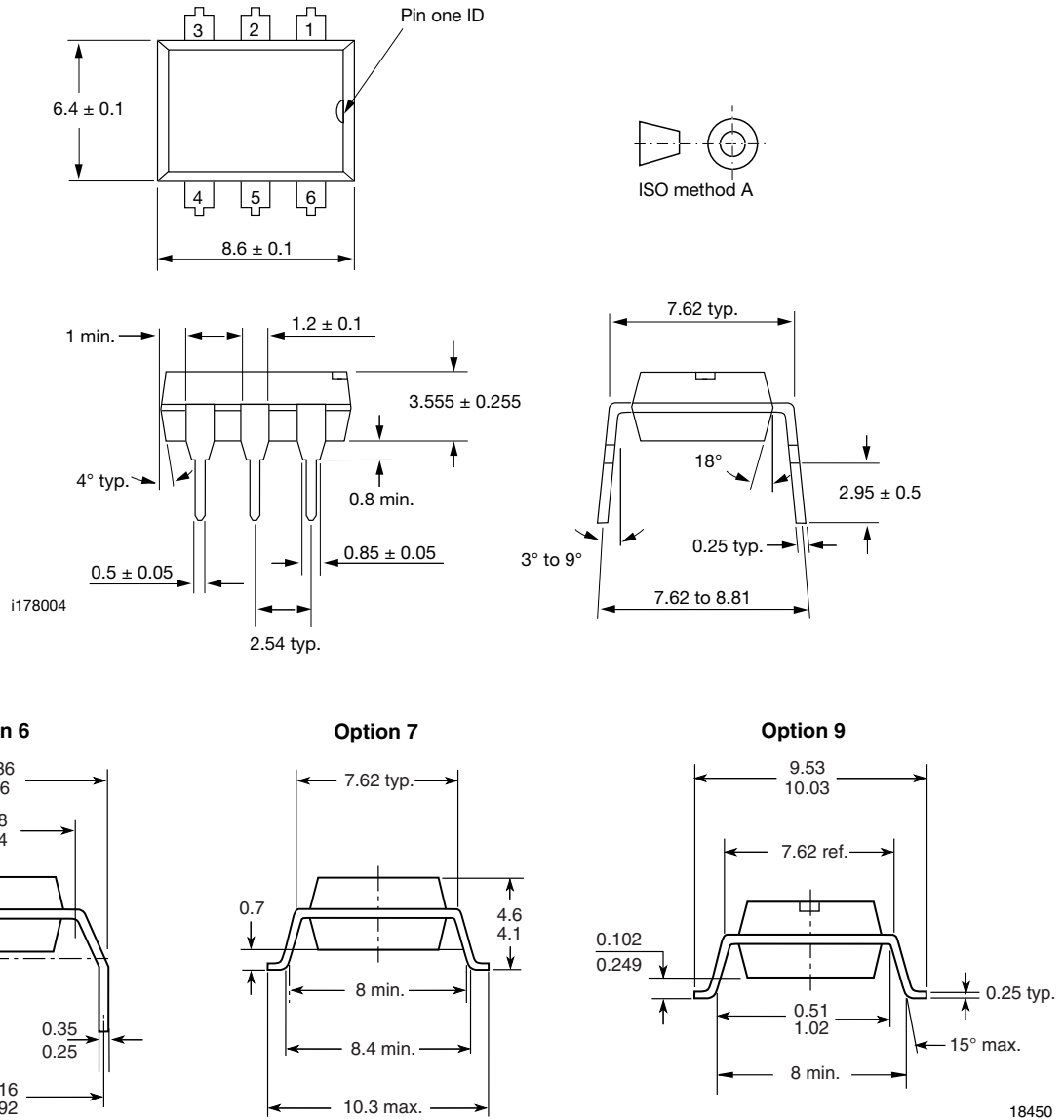

Fig. 7 - Maximum Output Power Dissipation



PACKAGE DIMENSIONS in millimeters



PACKAGE MARKING (example)

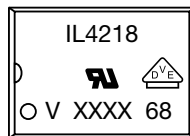
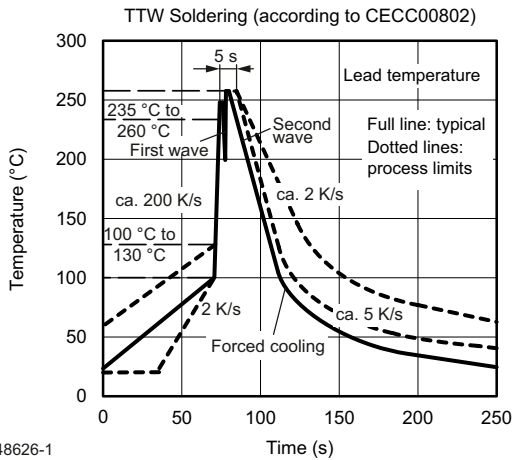

Fig. 8 - Example of IL4218-X017T

Notes

- XXXX = LMC (lot marking code)
- VDE logo is only marked on option 1 parts
- Tape and reel suffix (T) is not part of the package marking

SOLDER PROFILES



948626-1

Fig. 9 - Wave Soldering Double Wave Profile According to J-STD-020 for DIP Devices

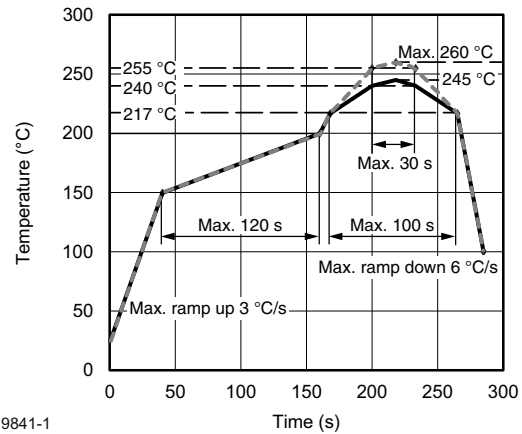

19841-1

Fig. 10 - Lead (Pb)-free Reflow Solder Profile According to J-STD-020 for SMD Devices

HANDLING AND STORAGE CONDITIONS

ESD level: HBM class 2

Floor life: unlimited

Conditions: $T_{amb} < 30\text{ °C}$, $RH < 85\%$

Moisture sensitivity level 1, according to J-STD-020



Disclaimer

ALL PRODUCT, PRODUCT SPECIFICATIONS AND DATA ARE SUBJECT TO CHANGE WITHOUT NOTICE TO IMPROVE RELIABILITY, FUNCTION OR DESIGN OR OTHERWISE.

Vishay Intertechnology, Inc., its affiliates, agents, and employees, and all persons acting on its or their behalf (collectively, "Vishay"), disclaim any and all liability for any errors, inaccuracies or incompleteness contained in any datasheet or in any other disclosure relating to any product.

Vishay makes no warranty, representation or guarantee regarding the suitability of the products for any particular purpose or the continuing production of any product. To the maximum extent permitted by applicable law, Vishay disclaims (i) any and all liability arising out of the application or use of any product, (ii) any and all liability, including without limitation special, consequential or incidental damages, and (iii) any and all implied warranties, including warranties of fitness for particular purpose, non-infringement and merchantability.

Statements regarding the suitability of products for certain types of applications are based on Vishay's knowledge of typical requirements that are often placed on Vishay products in generic applications. Such statements are not binding statements about the suitability of products for a particular application. It is the customer's responsibility to validate that a particular product with the properties described in the product specification is suitable for use in a particular application. Parameters provided in datasheets and / or specifications may vary in different applications and performance may vary over time. All operating parameters, including typical parameters, must be validated for each customer application by the customer's technical experts. Product specifications do not expand or otherwise modify Vishay's terms and conditions of purchase, including but not limited to the warranty expressed therein.

Hyperlinks included in this datasheet may direct users to third-party websites. These links are provided as a convenience and for informational purposes only. Inclusion of these hyperlinks does not constitute an endorsement or an approval by Vishay of any of the products, services or opinions of the corporation, organization or individual associated with the third-party website. Vishay disclaims any and all liability and bears no responsibility for the accuracy, legality or content of the third-party website or for that of subsequent links.

Except as expressly indicated in writing, Vishay products are not designed for use in medical, life-saving, or life-sustaining applications or for any other application in which the failure of the Vishay product could result in personal injury or death. Customers using or selling Vishay products not expressly indicated for use in such applications do so at their own risk. Please contact authorized Vishay personnel to obtain written terms and conditions regarding products designed for such applications.

No license, express or implied, by estoppel or otherwise, to any intellectual property rights is granted by this document or by any conduct of Vishay. Product names and markings noted herein may be trademarks of their respective owners.