



Designing the VEML6070 UV Light Sensor Into Applications

By Reinhard Schaar

UV LIGHT SENSOR WITH I²C INTERFACE

The VEML6070 is an advanced ultraviolet (UVA) light sensor designed with a CMOS process and featuring an I²C protocol interface.

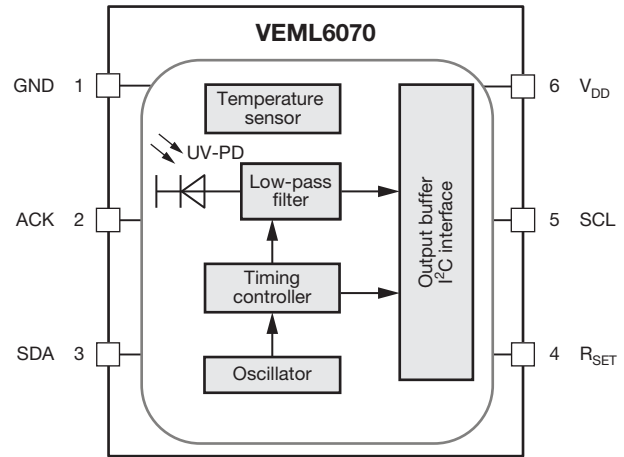
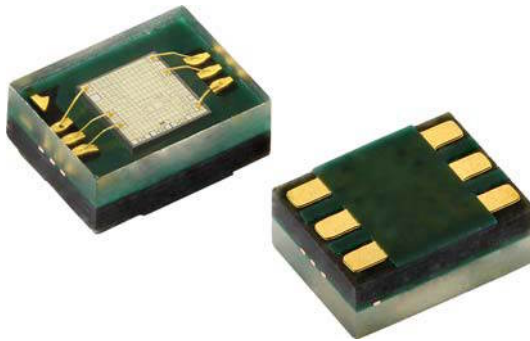

Fig. 1 - Block Diagram of the VEML6070

The VEML6070 is easily operated via a simple I²C command. The active acknowledge (ACK) feature with threshold window settings allows the UV sensor to send out a UVI alert message. Under a strong solar UVI condition, the smart ACK signal can be easily implemented by the software programming. The VEML6070 incorporates a photodiode, amplifiers, and analog / digital circuits into a single chip. The VEML6070's adoption of Filtron™ UV technology provides the best spectral sensitivity to cover UV spectrum sensing. It has an excellent temperature compensation and a robust refresh rate setting that does not use an external RC low-pass filter. The VEML6070 shows linear sensitivity to solar UV light, which can easily be adjusted by selecting the proper external resistor.

The device can be used as a solar UV indicator for handheld cosmetic / outdoor sports products or any kind of consumer products.

The VEML6070 comes within a very small surface-mount package with dimensions of just 2.35 x 1.8 x 1.0 (L x W x H in mm). The VEML6070 operates within a supply voltage range of 2.7 V to 5.5 V. The necessary pull-up resistors at the I²C and ACK lines can be connected to the same supply as the microcontroller, between 1.7 V and 5.5 V.

APPLICATION NOTE

Designing the VEML6070 UV Light Sensor Into Applications

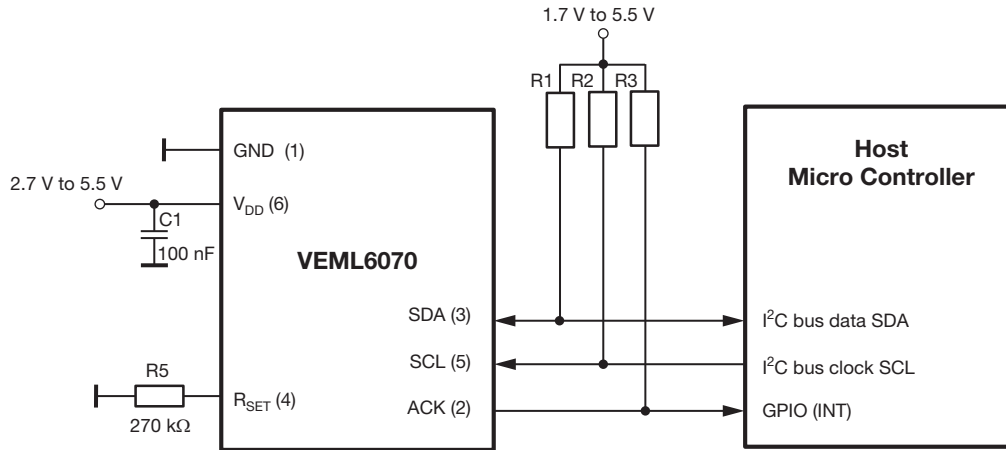

Fig. 2 - Application Circuit

The value for the pull-up resistors should be 2.2 kΩ.

The supply current of this device is also dependent on the R_{SET} value. When activated for measuring it is typically 100 μ A; in shut-down mode ($SD = 1$) it is typically just 1 μ A.

The resistor R_{SET} value at pin 4 of the VEML6070 needs to be selected depending on the application and required sensitivity. The table below shows how this value also affects the integration time that is programmed within the command register with bits 2 and 3 (IT_0 and IT_1).

EXAMPLE OF RELATION BETWEEN INTEGRATION TIME AND R_{SET} VALUE				
REGISTER	SETTING	REFRESH TIME		
		$R_{SET} = 300 \text{ k}\Omega$	$R_{SET} = 600 \text{ k}\Omega$	$R_{SET} = 1.2 \text{ M}\Omega$
(IT1 : IT0)	(0 : 0) = 1/2T	62.5 ms	125 ms	250 ms
	(0 : 1) = 1T	125 ms	250 ms	500 ms
	(1 : 0) = 2T	250 ms	500 ms	1000 ms
	(1 : 1) = 4T	500 ms	1000 ms	2000 ms

The VEML6070 shows its peak sensitivity at 355 nm. Bandwidth ($\lambda_{0.5}$) is achieved for a range of about 335 nm to 375 nm.

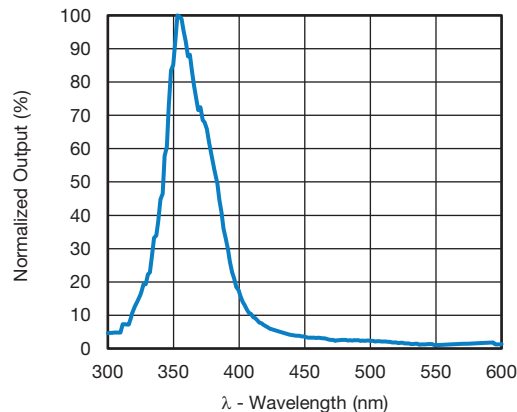

Fig. 3 - Relative Responsivity vs. Wavelength

Designing the VEML6070 UV Light Sensor Into Applications

What does this wavelength mean? To understand this, the diagram below shows that it is in the middle of the so-called UVA region.

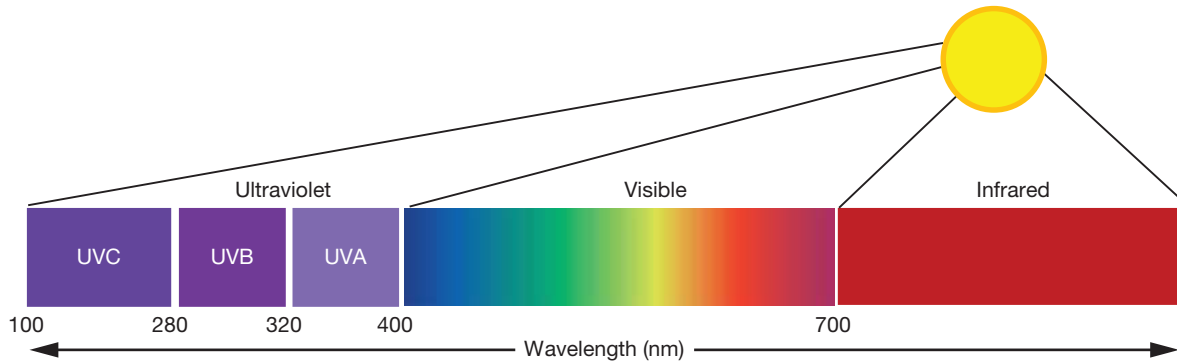

Fig. 4 - Light Spectrum

Visible light has wavelengths between 400 nm and 750 nm.
 UV light has shorter wavelengths, from 200 nm to 400 nm.
 UV type A has light with wavelengths between 320 nm and 400 nm.
 UV type B has wavelengths between 280 and 320 nm.
 UV type C is between 200 nm and 280 nm.

While UVA and UVB reach earth, UVC is blocked by our atmosphere, so it does not cause harm.

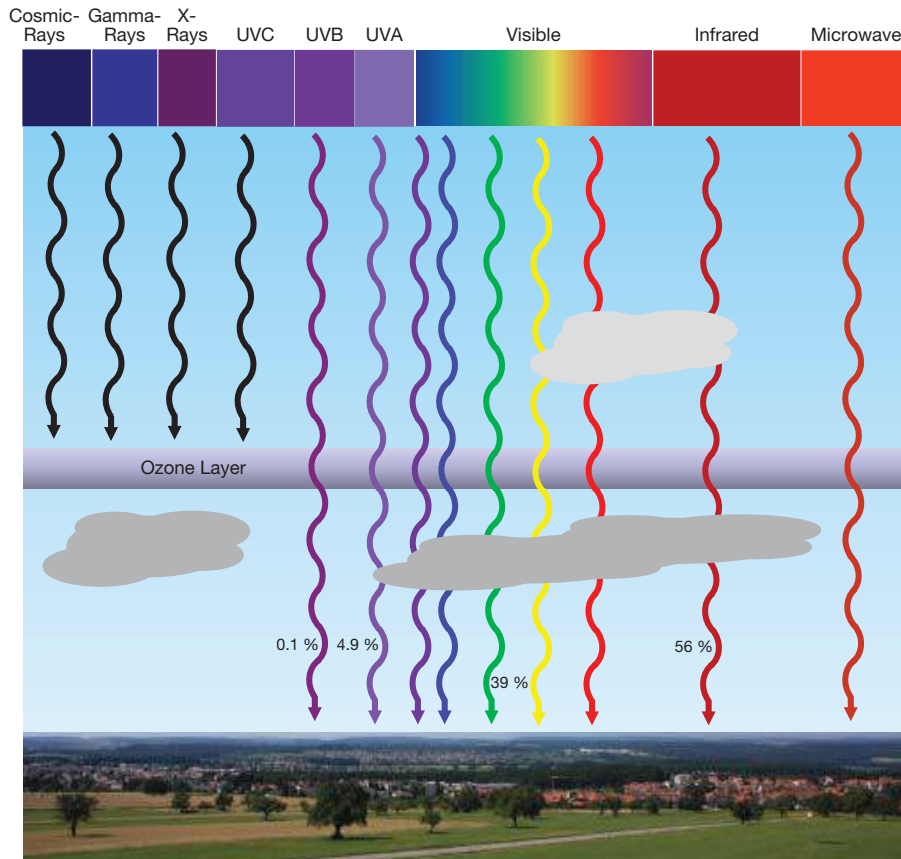

Fig. 5 - Radiation that Reaches the Earth's Surface

Designing the VEML6070 UV Light Sensor Into Applications

UVB rays - wavelengths ranging from 280 nm to 320 nm - are extremely energetic and harmful to the skin; they are responsible for 65 % of skin tumors. Thankfully, only 0.1 % of the solar energy that arrives on the earth's surface is in the form of UVB radiation.

UVA rays - wavelengths ranging from 320 nm to 400 nm - are less powerful than UVB rays, but are highly penetrating. They are capable of reaching the skin and are responsible for photoaging and the onset of different forms of skin cancer. 4.9 % of solar energy is made up of UVA rays.

In order to estimate the energy behind UV radiation and the risk level associated with it, the UV-index was established.

It is a quite complex calculation, weighted according to a curve and integrated over the whole spectrum. So, it cannot simply be related to the irradiance (measured in W/m^2).

The calculated index value appears on a scale of 0 to ≥ 11 . This index scale is linear and its relation to irradiance strength is shown below.

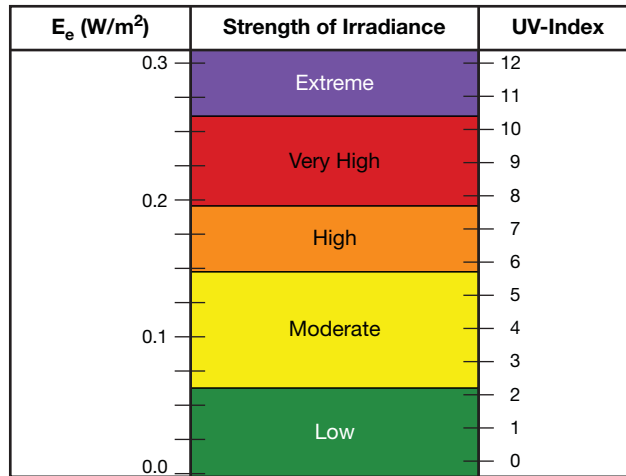

Fig. 6 - Strength of Irradiance and the UV-Index

In order to estimate the energy behind UV radiation and the risk level associated with it, the VEML6070 simply reads out the irradiance value and compares it with pre-defined values.

These given values are estimated, taking care to weigh the irradiance strength according to the wavelength and response performance of the VEML6070 (fig. 3).

Setting up and programming the VEML6070 is easily handled with just three I²C-bus addresses: 0x70, 0x71, and 0x73.

TABLE 1 - VEML6070 SLAVE ADDRESS AND FUNCTION DESCRIPTION	
SLAVE ADDRESS	OPERATION
0x70	Write command to VEML6070
0x72	Reserved
0x71	Read LSB 8 bits of VEML6070 ultraviolet light data
0x73	Read MSB 8 bits of VEML6070 ultraviolet light data



Designing the VEML6070 UV Light Sensor Into Applications

0x70 is the only command register where shut-down, integration time, and acknowledge activity settings are handled.

TABLE 2 - COMMAND REGISTER BITS DESCRIPTION							
COMMAND FORMAT							
Reserved		ACK	ACK_THD	IT		Reserved	SD
Bit 7	Bit 6	Bit 5	Bit 4	Bit 3	Bit 2	Bit 1	Bit 0
0	0	ACK	THD	IT1	IT0	1	SD
DESCRIPTION							
Reserved		Reserved					
ACK		Acknowledge activity setting					
ACK_THD		Acknowledge threshold window setting for byte mode usage					
IT		Integration time setting					
SD		Shutdown mode setting					

As previously discussed, integration time also depends on the external resistor at pin 4. Together with a R_{SET} value of 270 kΩ, the table below shows UV light data values that lead to the UVI values shown on the left side.

UVI	R _{SET} = 270 kΩ; IT = 1T	R _{SET} = 270 kΩ; IT = 2T	R _{SET} = 270 kΩ; IT = 4T	UV-INDEX
≥ 11	≥ 2055	≥ 4109	≥ 8217	Extreme
8 to 10	1494 to 2054	2989 to 4108	5977 to 8216	Very High
6, 7	1121 to 1494	2242 to 2988	4483 to 5976	High
3 to 5	561 to 1120	1121 to 2241	2241 to 4482	Moderate
0 to 2	0 to 560	0 to 1120	0 to 2240	Low

As previously mentioned, other resistor values lead to other integration times with different output data. At 540 kΩ, the 270 kΩ output data values are doubled, and the 540 kΩ values are doubled at 1 MΩ, which means that the sensitivity is also doubled.

UVI	R _{SET} = 540 kΩ; IT = 1T	R _{SET} = 540 kΩ; IT = 2T	R _{SET} = 540 kΩ; IT = 4T	UV-INDEX
0 to 2	0 to 1120	0 to 2240	0 to 4480	Low
3 to 5	1121 to 2241	2241 to 4482	4481 to 8964	Moderate
6, 7	2242 to 2988	4483 to 5976	8965 to 11 952	High
8 to 10	2989 to 4108	5977 to 8216	11 953 to 16 432	Very High
≥ 11	≥ 4109	≥ 8217	≥ 16 433	Extreme

UVI	R _{SET} = 1 MΩ; IT = 1T	R _{SET} = 1 MΩ; IT = 2T	R _{SET} = 1 MΩ; IT = 4T	UV-INDEX
0 to 2	0 to 2241	0 to 4482	0 to 8964	Low
3 to 5	2242 to 4482	4483 to 8964	8965 to 17 928	Moderate
6, 7	4483 to 5976	8965 to 11 952	17 929 to 23 904	High
8 to 10	5977 to 8217	11 953 to 16434	23 905 to 32 868	Very High
≥ 11	≥ 8218	≥ 16 435	≥ 32 869	Extreme

VEML6070 light data is available at 0x71 (LSB) and 0x73 (MSB). Together they show the whole 16-bit value and report the present UV light conditions. This 16-bit value is transferred into decimal form and becomes the base for calculating the corresponding UVI.

As already stated, the above values are evaluated taking care to weigh the wavelength and response performance of the VEML6070. Factoring in the R_{SET} value and integration time leads to the UVI values.

Designing the VEML6070 UV Light Sensor Into Applications

WHAT VALUES MAY BE SEEN WITH THE VEML6070?

If no exact UV light source is available to check the performance of the VEML6070, and only “normal” daylight is being used to study the VEML6070’s response, please note that the UV power is dependent on the time of day, season, and location where the measurements will be performed. During the winter, the total skin-affecting irradiance may be so low that even within full sunshine no remarkable values will be seen.

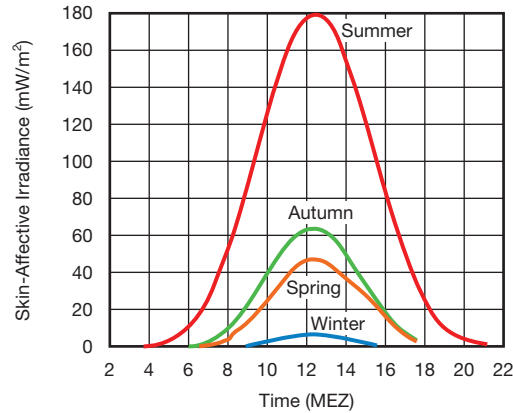

Fig. 7 - Skin Affecting Irradiance Level vs. Time Seen at the Beginning of the Four Seasons

MECHANICAL CONSIDERATIONS AND WINDOW CALCULATIONS FOR THE VEML6070

The UV sensor will be placed behind a window or cover. The window material should not only be completely transmissive to visible light (400 nm to 700 nm), but also at least to UVA wavelengths of 320 nm to 400 nm.

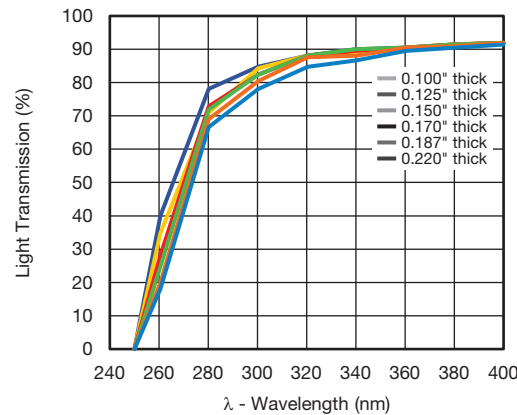

Fig. 8 - Light Transmission of ACRYLITE OP-4 Sheet
(www.aetnplastics.com/site_media/media/documents/Acrylite_OP-4_Material_Data_Sheet.pdf)

Designing the VEML6070 UV Light Sensor Into Applications

For optimal performance, the window size should be large enough to maximize the light irradiating the sensor. In calculating the window size, the only dimensions that the design engineer needs to consider are the distance from the top surface of the sensor to the outside surface of the window and the size of the window. These dimensions will determine the size of the detection zone. First, the center of the sensor and center of the window should be aligned. The VEML6070 has an angle of half sensitivity of about $\pm 55^\circ$, as shown in the figure below.

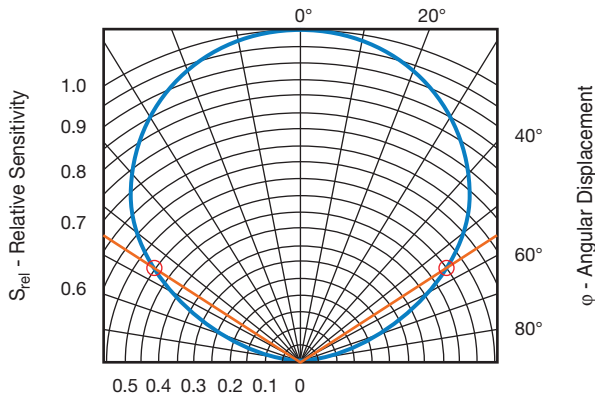

Fig. 9 - Relative Radiant Sensitivity vs. Angular Displacement

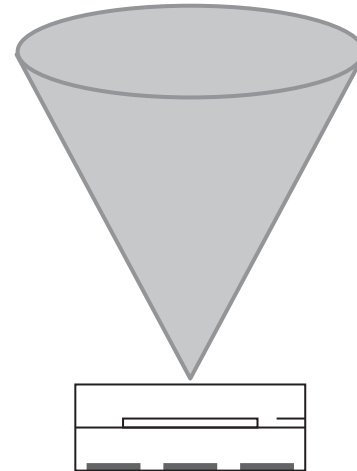

Fig. 10 - Angle of Half Sensitivity: Cone

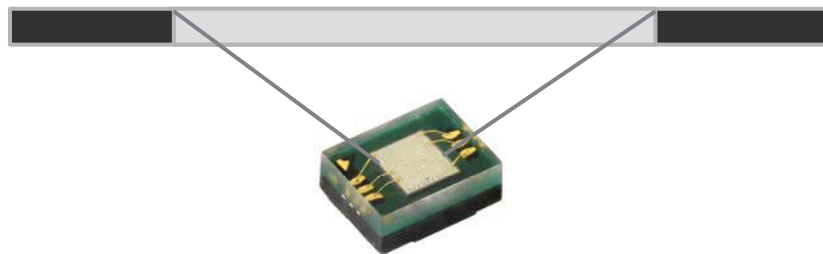

Fig. 11 - Window Above Sensitive Area

Remark:

This wide angle and the placement of the sensor as close as possible to the cover is needed to show good responsivity.

Designing the VEML6070 UV Light Sensor Into Applications

The size of the window is simply calculated according to triangular rules. The dimensions of the device, as well as the sensitive area, are shown within the datasheet. For best results, the distance below the window's upper surface and the specified angle below the given window diameter (*w*) are known.

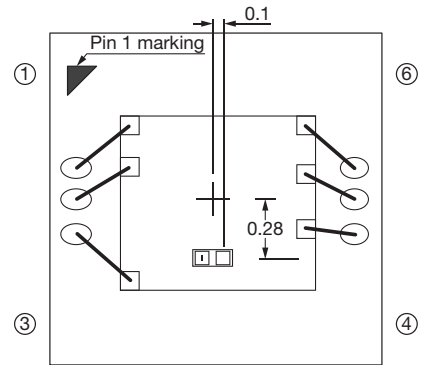
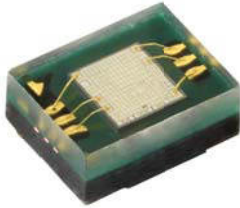

Dimensions (L x W x H in mm): 2 x 2 x 0.85

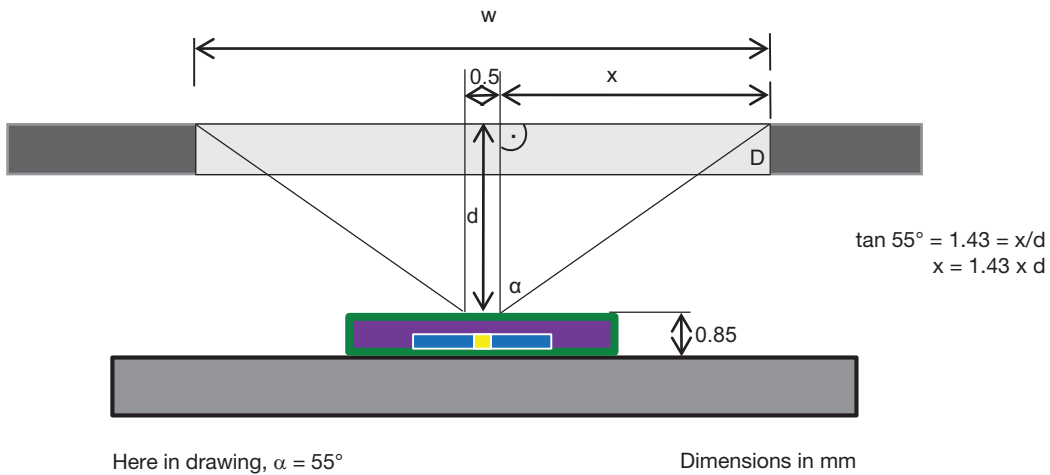

Fig. 12 - Window Area for an Opening Angle of $\pm 55^\circ$

The calculation is then: $\tan \alpha = x/d \rightarrow$ with $\alpha = 55^\circ$ and $\tan 55^\circ = 1.43 = x/d \rightarrow x = 1.43 \times d$
Then the total width is $w = 0.5 \text{ mm} + 2 \times x$.

$d = 0.5 \text{ mm}$	\rightarrow	$x = 0.72 \text{ mm}$	\rightarrow	$w = 0.5 \text{ mm} + 1.44 \text{ mm}$	$= 1.94 \text{ mm}$
$d = 1.0 \text{ mm}$	\rightarrow	$x = 1.43 \text{ mm}$	\rightarrow	$w = 0.5 \text{ mm} + 2.86 \text{ mm}$	$= 3.36 \text{ mm}$
$d = 1.5 \text{ mm}$	\rightarrow	$x = 2.15 \text{ mm}$	\rightarrow	$w = 0.5 \text{ mm} + 4.30 \text{ mm}$	$= 4.80 \text{ mm}$
$d = 2.0 \text{ mm}$	\rightarrow	$x = 2.86 \text{ mm}$	\rightarrow	$w = 0.5 \text{ mm} + 5.72 \text{ mm}$	$= 6.22 \text{ mm}$
$d = 2.5 \text{ mm}$	\rightarrow	$x = 3.58 \text{ mm}$	\rightarrow	$w = 0.5 \text{ mm} + 7.16 \text{ mm}$	$= 7.66 \text{ mm}$
$d = 3.0 \text{ mm}$	\rightarrow	$x = 4.29 \text{ mm}$	\rightarrow	$w = 0.5 \text{ mm} + 8.58 \text{ mm}$	$= 9.08 \text{ mm}$

Designing the VEML6070 UV Light Sensor Into Applications

A smaller window will also be sufficient, although it will reduce the total sensitivity of the sensor.

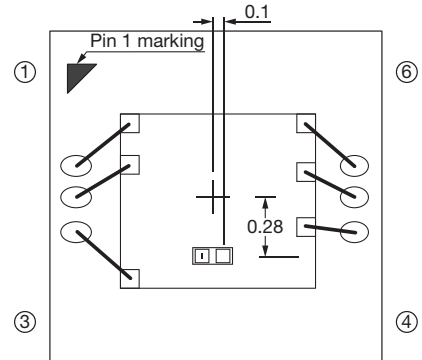
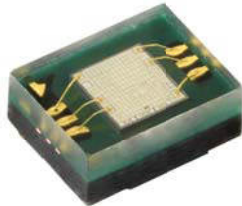

Dimensions (L x W x H in mm): 2 x 2 x 0.85

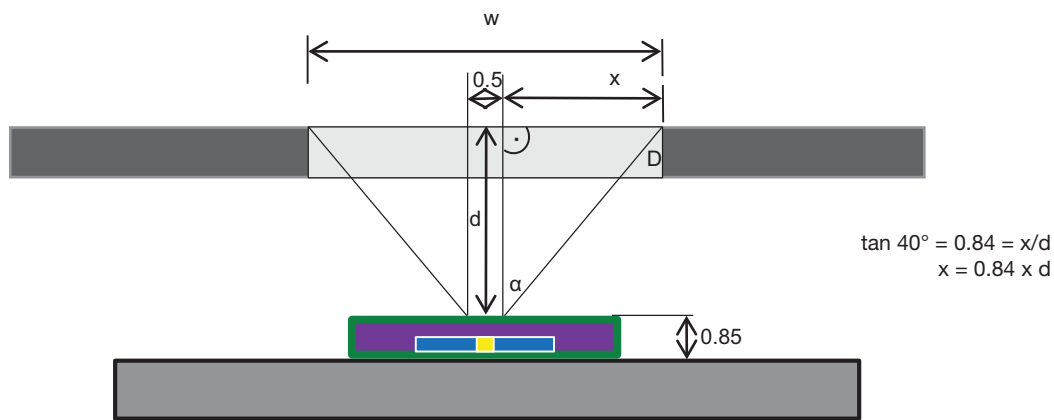

Here in drawing, $\alpha = 40^\circ$

Dimensions in mm

Fig. 13 - Window Area for an Opening Angle of $\pm 40^\circ$

The calculation is then: $\tan \alpha = x/d \rightarrow$ with $\alpha = 40^\circ$ and $\tan 40^\circ = 0.84 = x/d \rightarrow x = 0.84 \times d$

Then the total width is $w = 0.5 \text{ mm} + 2 \times x$.

$d = 0.5 \text{ mm}$	\rightarrow	$x = 0.42 \text{ mm}$	\rightarrow	$w = 0.5 \text{ mm} + 0.84 \text{ mm}$	$=$	1.34 mm
$d = 1.0 \text{ mm}$	\rightarrow	$x = 0.84 \text{ mm}$	\rightarrow	$w = 0.5 \text{ mm} + 1.68 \text{ mm}$	$=$	2.18 mm
$d = 1.5 \text{ mm}$	\rightarrow	$x = 1.28 \text{ mm}$	\rightarrow	$w = 0.5 \text{ mm} + 2.56 \text{ mm}$	$=$	3.06 mm
$d = 2.0 \text{ mm}$	\rightarrow	$x = 1.68 \text{ mm}$	\rightarrow	$w = 0.5 \text{ mm} + 3.36 \text{ mm}$	$=$	3.86 mm
$d = 2.5 \text{ mm}$	\rightarrow	$x = 2.10 \text{ mm}$	\rightarrow	$w = 0.5 \text{ mm} + 4.20 \text{ mm}$	$=$	4.70 mm
$d = 3.0 \text{ mm}$	\rightarrow	$x = 2.52 \text{ mm}$	\rightarrow	$w = 0.5 \text{ mm} + 5.04 \text{ mm}$	$=$	5.54 mm

Designing the VEML6070 UV Light Sensor Into Applications

VEML6070 SENSOR BOARD AND DEMO SOFTWARE

The small blue VEML6070 sensor board fits to the SensorXplorer™ demonstration kit. Please also see: www.vishay.com/optoelectronics/SensorXplorer.

With the help of the VEML6070 sensor board and the demo software, one can easily test the UV sensor. Four possible integration times are selectable. Associated result counts are strictly linear, meaning a factor of 2 in integration time results in a factor of 2 in output data counts.

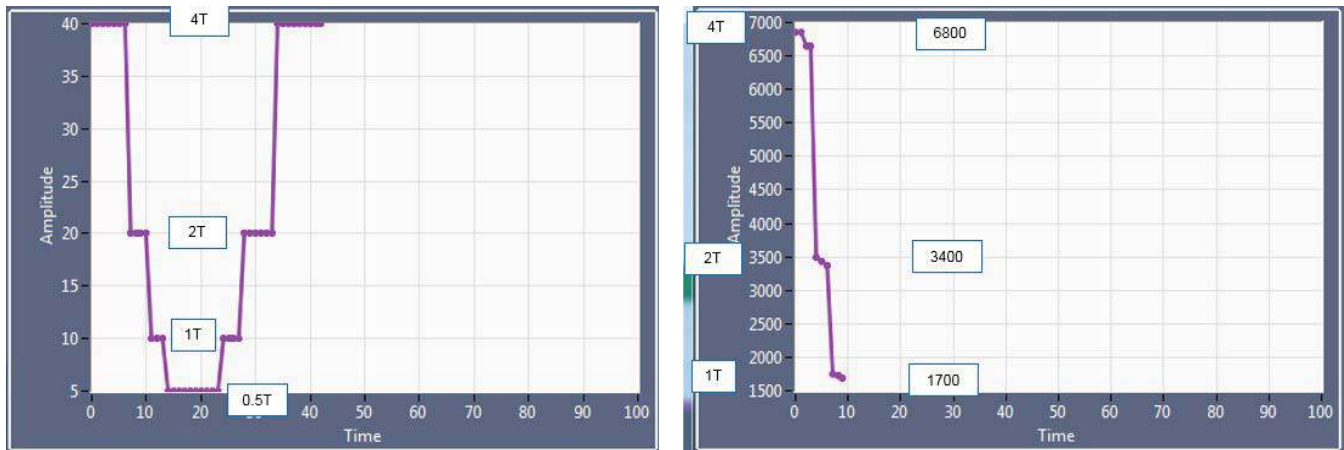

Fig. 14 - Linearity of Integration Times for Small and High Data Values

In addition to the raw data read out of registers 0x71 and 0x73, the corresponding UV-index is shown, as well as the risk level indicated with the changing color (fig. 6).

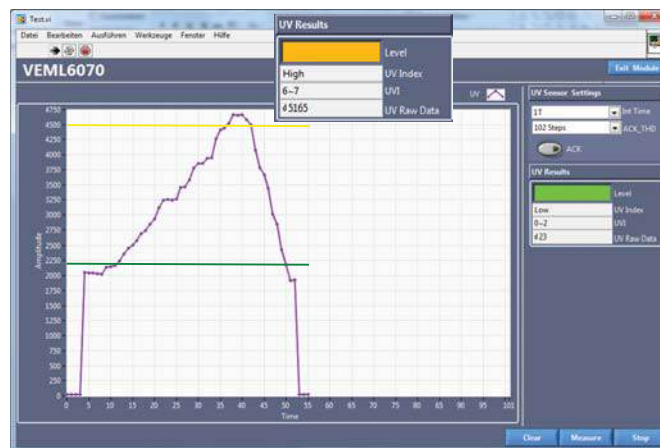

Fig. 15 - View of the VEML6070 Demo Software Showing Raw Data, UVI, and Risk Level



Designing the VEML6070 UV Light Sensor Into Applications

VEML6070 REFERENCE SOFTWARE CODE

```

#define VEML6070_ADDR_ARA          (0x18 >> 1)
#define VEML6070_ADDR_CMD         (0x70 >> 1)
#define VEML6070_ADDR_DATA_LSB    (0x71 >> 1)
#define VEML6070_ADDR_DATA_MSB    (0x73 >> 1)

// VEML6070 command register bits
#define VEML6070_CMD_SD           0x01
#define VEML6070_CMD_IT_0_5T     0x00
#define VEML6070_CMD_IT_1T       0x04
#define VEML6070_CMD_IT_2T       0x08
#define VEML6070_CMD_IT_4T       0x0C
#define VEML6070_CMD_DEFAULT      (VEML6070_CMD_WDM |
VEML6070_CMD_IT_1T)

type enum {LOW, MODERATE, HIGH, VERY_HIGH, EXTREME} RISK_LEVEL;

BYTE cmd = VEML6070_CMD_DEFAULT;
WORD uvs_step;
RISK_LEVEL risk_level;

struct i2c_msg {
    WORD addr;
    WORD flags;
#define I2C_M_TEN                0x0010
#define I2C_M_RD                 0x0001
#define I2C_M_NOSTART            0x4000
#define I2C_M_REV_DIR_ADDR      0x2000
#define I2C_M_IGNORE_NAK        0x1000
#define I2C_M_NO_RD_ACK         0x0800
#define I2C_M_RECV_LEN          0x0400
    WORD len;
    BYTE *buf;
};

extern int i2c_transfer(struct i2c_msg *msgs, int num);

//-----
// C main function
//-----
void main(void)
{
    initialize_VEML6070();

    // Loop for polling VEML6070 data
    while (1)

```

APPLICATION NOTE



Designing the VEML6070 UV Light Sensor Into Applications

```
{
    uvvs_step = read_uvvs_step();
    risk_level = convert_to_risk_level(uvvs_step);

    delay(1000);
}

void initialize_VEML6070(void)
{
    // Read ARA to clear interrupt
    BYTE address;
    VEML6070_read_byte(VEML6070_ADDR_ARA, &address);

    // Initialize command register
    VEML6070_write_byte(VEML6070_ADDR_CMD, cmd);

    delay(200);
}

void enable_sensor(void)
{
    cmd &= ~VEML6070_CMD_SD;
    VEML6070_write_byte(VEML6070_ADDR_CMD, cmd);
}

void disable_sensor(void)
{
    cmd |= VEML6070_CMD_SD;
    VEML6070_write_byte(VEML6070_ADDR_CMD, cmd);
}

WORD read_uvvs_step(void)
{
    BYTE lsb, msb;
    WORD data;

    VEML6070_read_byte(VEML6070_ADDR_DATA_MSB, &msb);
    VEML6070_read_byte(VEML6070_ADDR_DATA_LSB, &lsb);

    data = ((WORD)msb << 8) | (WORD)lsb;

    return data;
}

RISK_LEVEL convert_to_risk_level(WORD uvvs_step)
{
    WORD risk_level_mapping_table[4] = {2241, 4482, 5976, 8217};
}
```



Designing the VEML6070 UV Light Sensor Into Applications

```
WORD i;
    for (i = 0; i < 4; i++)
    {
        if (uvs_step <= risk_level_mapping_table[i])
        {
            break;
        }
    }
    return (RISK_LEVEL);
}

int VEML6070_read_byte(WORD addr, BYTE *data)
{
    int err = 0;
    int retry = 3;
    struct i2c_msg msg;

    // Read byte data
    msg.addr = addr;
    msg.flags = I2C_M_RD;
    msg.len = 1;
    msg.buf = data;

    while (retry--)
    {
        err = i2c_transfer(msg, 1);
        if (err >= 0)
            return err;
    }

    return err;
}

int VEML6070_write_byte(WORD addr, BYTE data)
{
    int err = 0;
    int retry = 3;
    struct i2c_msg msg;

    while (retry--)
    {
        // Send slave address & command
        msg.addr = addr;
        msg.flags = I2C_M_WR;
        msg.len = 1;
        msg.buf = &data;
        err = i2c_transfer(msg, 1);

        if (err >= 0)
            return 0;}

    return err;
}
```



Designing the VEML6070 UV Light Sensor Into Applications

THE VEML6070'S ACK SIGNAL

The VEML6070 features a function for sending an acknowledge signal (ACK) to the microcontroller when the UV value changes are bigger than one of two pre-programmable step sizes: ACK_THD. The purpose of the ACK signal is similar to an interrupt feature, which informs the μ C once the sensed data level goes below or beyond the interrupt threshold setting. The ACK threshold values are 102 steps and 145 steps.

0x70, bit 5	ACK	0: disabled 1: enabled
0x70, bit 4	ACK_THD	0: 102 steps 1: 145 steps

There are two methods for driving acknowledge conditions and read / write commands to the VEML6070:

If the host implements the INT function, it performs a modified received byte operation to disengage the VEML6070's acknowledge signal and acknowledge alert response address (ARA), 0x18 (hex). A command format for responses to an ARA looks like this:

S	ARA (0x18)	Rd	A	UVS Slave Address	A	P
---	------------	----	---	-------------------	---	---

Please note the following:

1. When the VEML6070 is connected to V_{DD} , the sensors may be in an undefined state. This may lead to an initially active interrupt, even though no measurements have been made i.e. no threshold has been crossed
2. When the interrupt is active, only the ARA register can be accessed, as the other registers are blocked until the interrupt is cleared and these will respond with a "NACK" when an attempt is made to access them. The interrupt is cleared by reading the ARA register
3. It is therefore mandatory to clear this interrupt after power on, so that the sensor settings can be accessed and used to make measurements
4. It is possible that after the first time one reads the ARA register the interrupt is not directly cleared and the access to the control registers are still blocked. One may need to clear it again. Therefore it is recommended that one reads the ARA register until it responds with a "NACK" to be certain that the interrupt has been cleared successfully
5. If the interrupt function of the sensor is no longer used in the application from this point onwards, no further care needs to be taken in regard of the ARA register
6. If the interrupt function is used, please be sure to follow the above instructions to clear the interrupt again before attempting to access the sensor settings

For the hardware circuit design, this pin should be connected to an INT pin or GPIO pin of the MCU. The threshold ACK_THD definition is based on the sensitivity setting of the VEML6070.

The ACK or UVI interrupt function allows the UVI sensing system to perform data polling based on the interrupt event. The system sensor manager does not need to do continual data polling and this significantly reduces the MCU loading. The ACK signal can also be used as a trigger event for popping up a warning UVI message.