



Designing the VEML6075 Into an Application

By Reinhard Schaar

UVA / UVB LIGHT SENSOR WITH I²C INTERFACE

The VEML6075 is an advanced ultraviolet (UVA / UVB) light sensor with an I²C protocol interface and designed in the CMOS process.

An accurate VEML6075 UVI sensing system requires visible and infrared noise compensation and a teflon diffusor for cosine angular response correction. The UVI formulas and related UVI formula coefficients are discussed here in detail. The coefficient extraction method and a calculated example are also presented in this application note.

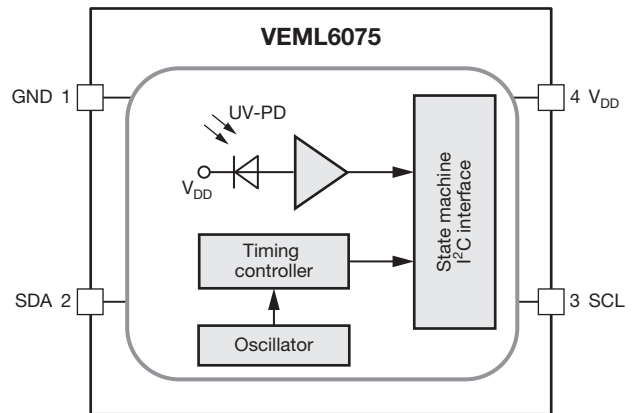
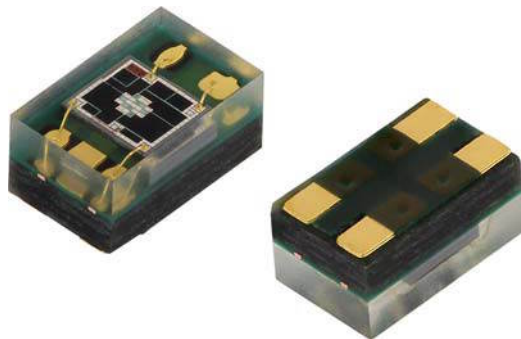

Fig. 1 - Block Diagram of the VEML6075

The VEML6075 is easily operated via a simple I²C command. It incorporates a photodiode, amplifiers, and analog / digital circuits into a single chip. The VEML6075's adoption of Filtron™ UV technology provides the best spectral sensitivity to cover UVA and UVB spectrum sensing. It has excellent temperature compensation and a robust refresh rate setting without the need for an external RC low-pass filter.

The VEML6075 shows linear sensitivity to solar UVA as well as UVB light and its sensitivity can easily be adjusted with selecting the proper integration times.

The device can be used as a solar UV indicator for cosmetic / outdoor sport handheld products or any kind of consumer products.

The VEML6075 comes within a very small surface-mount package with dimensions of just 2.0 mm x 1.25 mm x 1.0 mm (L x W x H).

The VEML6075 operates within a supply voltage range from 1.7 V to 3.6 V. The necessary pull-up resistors at the I²C line can be connected to the same supply as the micro controller is connected to, between 1.7 V and 3.6 V.

APPLICATION NOTE

Designing the VEML6075 Into an Application

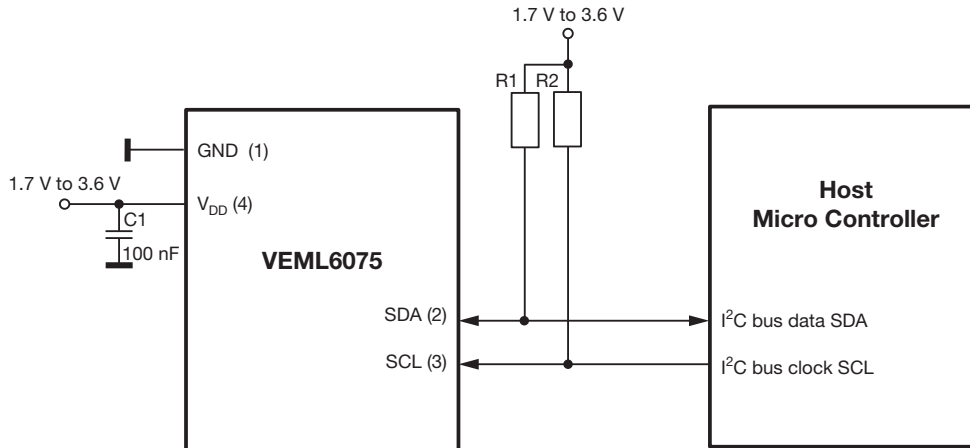

Fig. 2 - Application Circuit

The value for the pull-up resistors should be 2.2 k Ω .

The supply current of this device in activated measuring mode is 500 μ A typical, whereas in shut-down mode (SD = 1) it is typically just 800 nA. The operating temperature range is specified for -40 $^{\circ}$ C to +85 $^{\circ}$ C.

BASIC CHARACTERISTICS ($T_{amb} = 25^{\circ}\text{C}$, unless otherwise specified)						
PARAMETER	TEST CONDITION	SYMBOL	MIN.	TYP.	MAX.	UNIT
Supply operation voltage		V_{DD}	1.7	-	3.6	V
Supply current		I_{DD}	-	480	-	μ A
I ² C signal input	Logic high	$V_{DD} = 3.3\text{ V}$	V_{IH}	1.5	-	V
	Logic low		V_{IL}	-	0.8	
I ² C signal input	Logic high	$V_{DD} = 2.6\text{ V}$	V_{IH}	1.4	-	V
	Logic low		V_{IL}	-	0.6	
Operating temperature		T_{amb}	-40	-	+85	$^{\circ}$ C
Shutdown current	Light condition = dark; $V_{DD} = 1.8\text{ V}$, $T_{amb} = 25^{\circ}\text{C}$	$I_{DD} (SD)$	-	800	-	nA
UVA responsivity	$I_T = 50\text{ ms}^{(1)}$		-	0.93	-	counts/ μ W/cm ²
UVB responsivity	$I_T = 50\text{ ms}^{(2)}$		-	2.1	-	counts/ μ W/cm ²

Notes

- (1) Nichia NCSU033X (365 nm)
- (2) UVTOP310TO39HS (315 nm)

Designing the VEML6075 Into an Application

The VEML6075 shows a peak sensitivity at 365 nm for the UVA channel and 330 nm for the UVB channel.

The bandwidth ($\lambda_{0.5}$) of this UVB peak is in a range of about 315 nm to 340 nm.

The bandwidth ($\lambda_{0.5}$) of the UVA channel is within a range of about 350 nm to 375 nm. Its irradiance responsivity is about half when compared with the UVB channel.

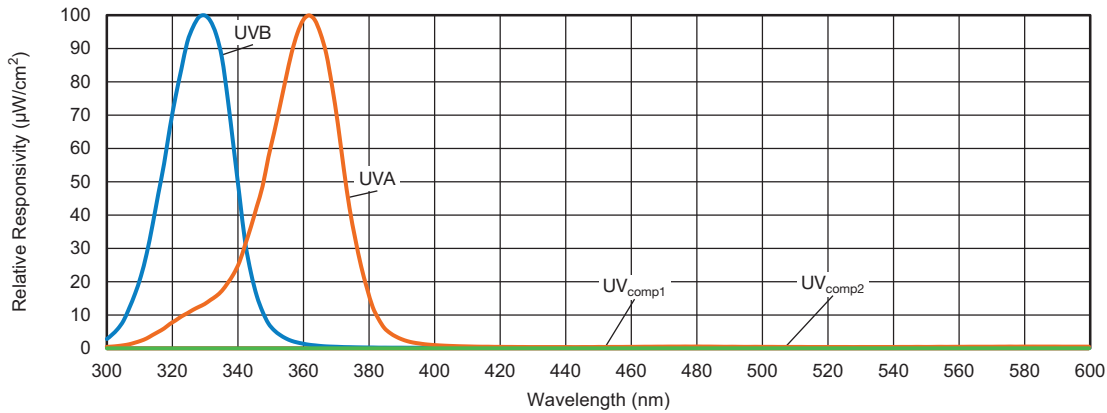

Fig. 3 - Relative Responsivity vs. Wavelength Including Response at Higher Wavelength

What does this wavelength mean? To understand this, the diagram below shows that 315 nm is within the so-called UVB region, and 365 nm well in mid of UVA region.

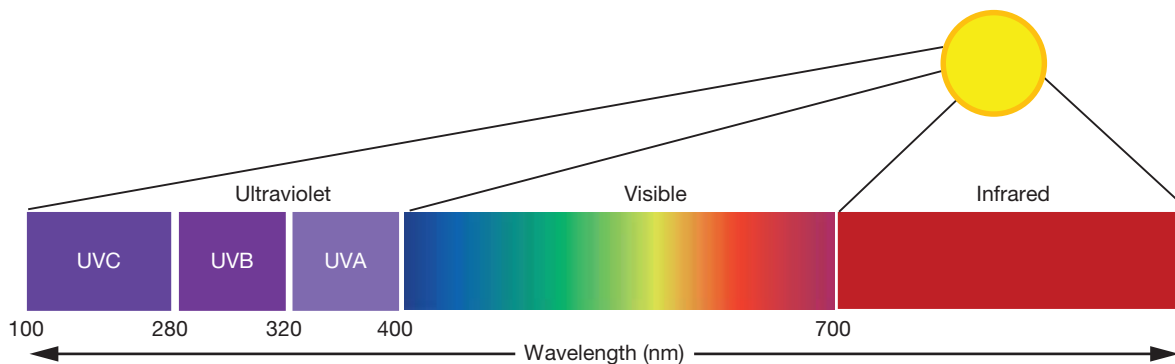

Fig. 4 - Light Spectrum

Designing the VEML6075 Into an Application

Visible light has wavelengths between 400 nm and 750 nm.
 UV light has shorter wavelengths, from 200 nm to 400 nm.
 UV type A has light with wavelengths between 320 nm and 400 nm.
 UV type B has wavelengths between 280 and 320 nm.
 UV type C is between 200 nm and 280 nm.

While UVA and UVB reach earth, UVC is blocked by our atmosphere, so it does no harm.

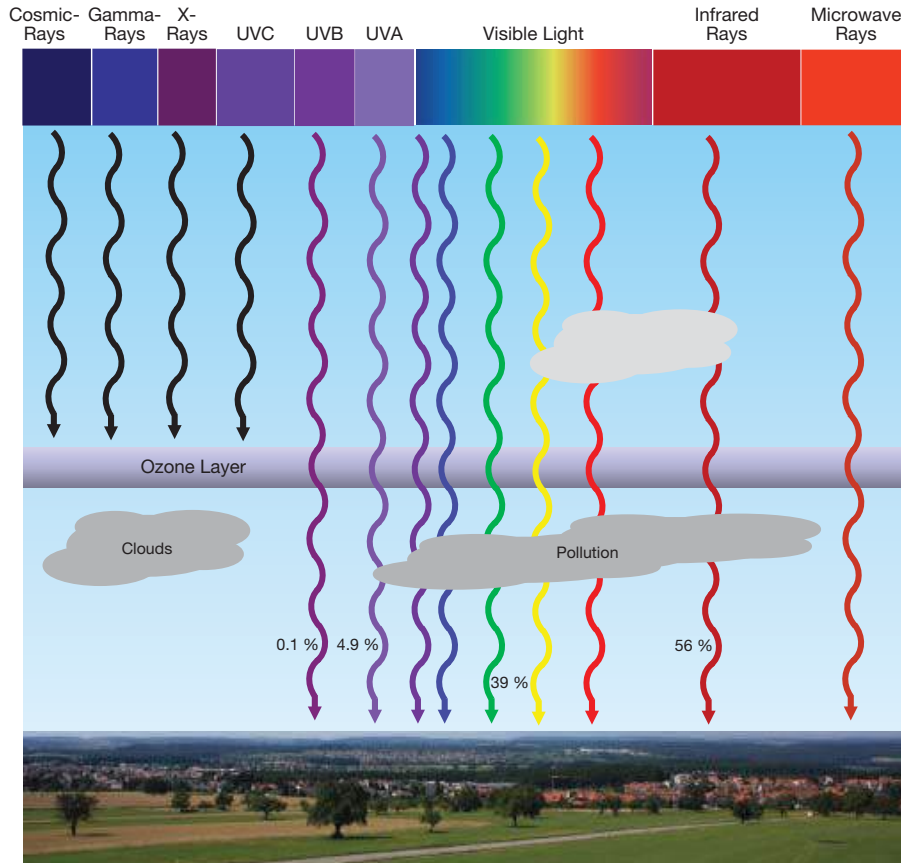

Fig. 5 - Radiation that Reaches Earth Surface

The UVB rays - wavelengths ranging from 280 nm to 320 nm - are extremely energetic and harmful for the skin to the extent that they are responsible for 65 % of skin tumors. Thankfully, only 0.1 % of the solar energy that arrives on the earth's surface is in the shape of UVB radiation.

The UVA rays - wavelengths ranging from 320 nm to 400 nm - are less powerful than the previous ones, but highly penetrating. They are capable of reaching the skin, becoming responsible for photoaging and promoting the onset of different forms of skin cancer. 4.9 % of the solar energy is made up of UVA rays.

Designing the VEML6075 Into an Application

In order to estimate the energy behind this UV radiation and the risk level seen with it, a so-called UV index has been established. It is a quite complex calculation, weighted according a curve and integrated over the whole spectrum. So, it cannot simply be related to the irradiance (measured in W/m^2). Also see Fig. 12.

The calculated index value appears on a scale of 0 to 11+. This index scale is linear and the relation to strength of the irradiance is shown below.

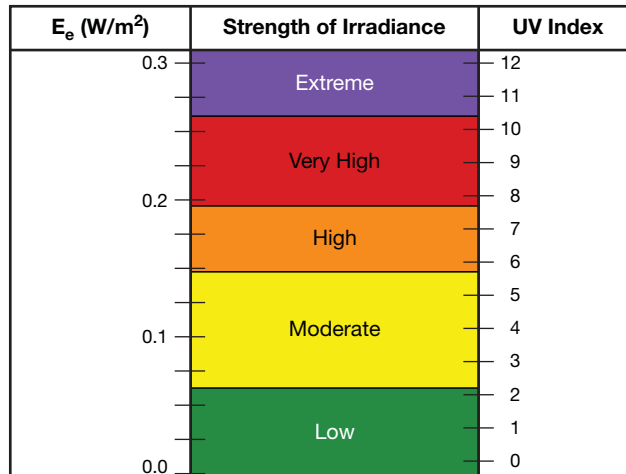

Fig. 6 - Strength of Irradiance and the UV Index

In order to define the energy behind this UV radiation and the risk level seen, the VEML6075 enables the simple reading out of the irradiance values and calculation of the exact measured UVA and UVB values. The visible and infrared noise is also measured and two compensation channels help to remove the solar visible and IR noise outside the UV region.

Setting up and programming the VEML6075 is easily handled by just one I²C-bus command register: command code “0”. All required functions that need to be set of are located there: power on (SD), integration time (IT), and measurement mode, either continuous or on-demand (UV_AF and UV_TRIG). The bit “HD” allows for increasing the dynamic. The five following 16-bit-wide command codes are the read register for the UV, as well as the so-called compensation data, and the last one shows information about the device ID.

REGISTER UV_CONF DESCRIPTION									
REGISTER NAME		COMMAND CODE: 0x00_L (0x00 DATA BYTE LOW) OR 0x00_H (0x00 DATA BYTE HIGH)							
COMMAND	BIT	7	6	5	4	3	2	1	0
REGISTER: UV_CONF		COMMAND CODE: 0x00_L (0x00 DATA BYTE LOW)							
COMMAND	BIT	Description							
Reserved	7	0							
UV_IT	6 : 4	(0 : 0 : 0) = 50 ms, (0 : 0 : 1) = 100 ms, (0 : 1 : 0) = 200 ms, (0 : 1 : 1) = 400 ms, (1 : 0 : 0) = 800 ms, (1 : 0 : 1) = reserved, (1 : 1 : 0) = reserved, (1 : 1 : 1) = reserved.							
HD	3	0 = normal dynamic setting, 1 = high dynamic setting							
UV_TRIG	2	0 = no active force mode trigger, 1 = trigger one measurement With UV_AF = 1 the VEML6075 conducts one measurement every time the host writes UV_Trig = 1. This bit returns to “0” automatically.							
UV_AF	1	0 = active force mode disable (normal mode), 1 = active force mode enable							
SD	0	0 = power on, 1 = shut down							



Designing the VEML6075 Into an Application

UVA data is available within command code 7 and UVB within command code 9.

07h	L	UVA_Data	R	0x00	UVA LSB output data
	H	UVA_Data	R	0x00	UVA MSB output data
09h	L	UVB_Data	R	0x00	UVB LSB output data
	H	UVB_Data	R	0x00	UVB MSB output data
0Ah	L	UVCOMP1_Data	R	0x00	UV _{comp1} LSB output data
	H	UVCOMP1_Data	R	0x00	UV _{comp1} MSB output data
0Bh	L	UVCOMP2_Data	R	0x00	UV _{comp2} LSB output data
	H	UVCOMP2_Data	R	0x00	UV _{comp2} MSB output data

In addition, command codes 10 (0x0A) and 11 (0x0B) contain so-called compensation values. These deliver information about the whole received light within the visible wavelength area (0x0A) and the strength of the infrared content within the received light (0x0B).

The last command code 12 (0x0C) contains information about the device ID:

ID	0x0C_L (0x0C data byte low)	07:00	Default = 0x26, device ID LSB byte
	0x0C_H (0x0C data byte high)	07:06 05:04 03:00	Company code = 00, (0 : 0) Slave address = 0x20 Version code (0 : 0 : 0 : 0) = VEML6075 CS Device ID MSB byte

Silicon photodiode detectors are known to have good optical response for visible and infrared light. Therefore, the injection of visible and infrared lights into silicon photodiodes generates undesirable noise current. In order to correct such error sources, the VEML6075 incorporates UV_{comp1} and UV_{comp2} noise compensation channels.

- The UV_{comp1} channel allows only visible noise to pass through
- The UV_{comp2} channel allows only infrared noise to pass through

After reading the raw data through the I²C bus for all four channels (UVB, UVA, UV_{comp1}, and UV_{comp2}), simple UVA_{calc} and UVB_{calc} formulas are used to calculate the UVI signal.

$$UVA_{calc} = UVA - \frac{(a \times \alpha \times UV_{comp1})}{\gamma} - \frac{(b \times \alpha \times UV_{comp2})}{\delta} \quad \text{Eq. (1)}$$

$$UVB_{calc} = UVB - \frac{(c \times \beta \times UV_{comp1})}{\gamma} - \frac{(d \times \beta \times UV_{comp2})}{\delta} \quad \text{Eq. (2)}$$

These gain calibration factors, α , β , γ , δ , correct the output ratios of each channel for the device under test (DUT) in reference to the golden sample under a solar simulator, such as the Newport LCS100. A golden sample is created by measuring a DUT in reference to a calibrated UVI meter, such as the Davis Weather Station, when exposed to real sunlight. This process should be conducted with the device in its final enclosure as this may affect the angular response and sensitivity of the device.

$$\alpha = (UVA/UVA_{golden})$$

$$\beta = (UVB/UVB_{golden})$$

$$\gamma = (UV_{comp1}/UV_{comp1golden})$$

$$\delta = (UV_{comp2}/UV_{comp2golden})$$

$$K1 = (1/\alpha) \text{ and } K2 = (1/\beta)$$

$$UVIA = UVA_{calc} \times (1/\alpha) \times UVA_{responsivity}; \quad UVIB = UVB_{calc} \times (1/\beta) \times UVB_{responsivity} \quad \text{Eq. (3, 4)}$$

$$\text{Average UVI} = \frac{(UVIA + UVIB)}{2} \quad \text{Eq. (5)}$$

Notes

- Based on the actual UVI measurement data under various sunlight conditions, the average UVI from UVB and UVA signals provides a better UVI tracking with the reference Davis 6490 UVI sensor
- (1/ α) and (1/ β) are the calibrate gain factors using LCS100 solar simulator. The UVI calibration method using the α , β , γ , δ , output ratio factors to correct and compensate the mismatch between the golden sample and all other new produced devices under test provides a significant better UVI tracking between the Golden sample and the device under test (DUT)

Designing the VEML6075 Into an Application

For accurate calibration of the sensor within the ready-made application below its defined cover with exact specified thickness, transmissivity, and distance to the sensor and the chosen opening of the window for the sensor a solar simulator as light source should be used. Vishay test set-up using Oriel 66055 lamp, housing with a 150 W xenon lamp.

Best would be a solar simulator light source as e.g. this Newport solar simulator:
www.newport.com/f/small-area-solar-simulators.

This simulator is able to replicate, as closely as possible, the spectrum of the sun as given in the AM1.5G norm for sun output. It comes with an AM1.5 air mass filter to match the solar spectrum.

Coefficients (a, b, c, d) as well as UVA and UVB responsivity values could stay as shown within given table at page 15 but correction factors are needed to align for exact responsivity.

In both Eq. (1) and Eq. (2) formulas, there are four coefficients we need to solve for. Open-air systems could show not adequate results but for this as well as systems using a quite thin teflon diffusor of just up to 0.25 mm thickness, the following default VIS and IR coefficients are used:

- a = uva_a_coef = 2.22, which is the default value for the UVA VIS coefficient
- b = uva_b_coef = 1.33, which is the default value for the UVA IR coefficient
- c = uvb_c_coef = 2.95, which is the default value for the UVB VIS coefficient
- d = uvb_d_coef = 1.74, which is the default value for the UVB IR coefficient

For diffusor thickness of 0.4 mm and 0.7 mm other / lower IR coefficients need to be used. These are: b = 1.17 and d = 1.58. The visible cancellation coefficients stay the same.

In the mass production process, each VEML6075 die will be trimmed under reference light sources to ensure a tight sensitivity distribution for UVI calculation.

To extract the visible and IR coefficients (a, b, c, and d), we need two light sources (WLED and incandescent) and set Eq. (1) and Eq. (2) to zero. α , β , γ , δ are not required in the equations for this step as they are responsible for part to part gain calibration. The a, b, c, d coefficients once found remain constant as shown in UV coefficients and responsivity table below.

$$UVA_{calc} = UVA - a \times UV_{comp1} - b \times UV_{comp2} = 0 \tag{Eq. (6)}$$

$$UVB_{calc} = UVB - c \times UV_{comp1} - d \times UV_{comp2} = 0 \tag{Eq. (7)}$$

Eq. (6) is solved for coefficients a and b using two light sources (WLED and incandescent).

Eq. (7) is solved for coefficients c and d using two light sources (WLED and incandescent).

With all calculations above eliminating the influence within the UVA and UVB response from visible and infrared content, the “clean” response of the UVA and UVB channel will look as shown in Fig. 7 below.

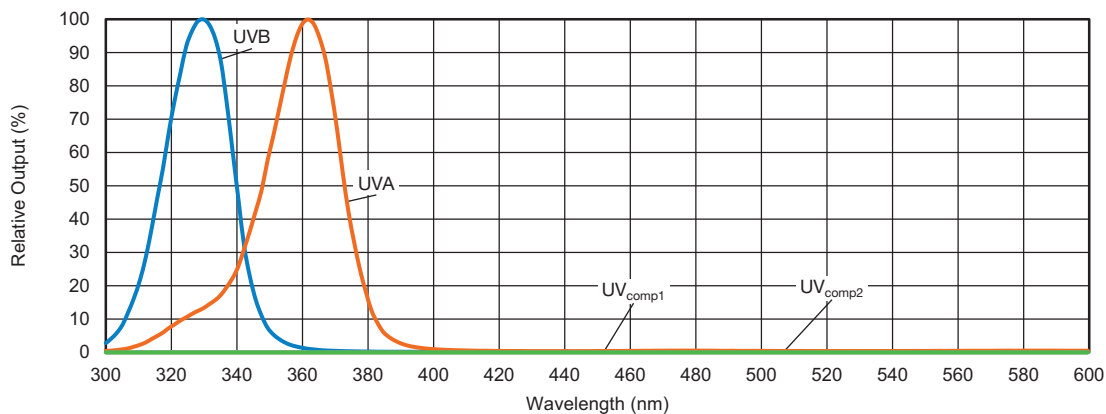

Fig. 7 - Relative Responsivity vs. Wavelength (Adjusted with Compensation Channels)

This may help to understand the sensor’s behavior when testing just with lab conditions and defined, calibrated light sources.

Designing the VEML6075 Into an Application



Fig. 8 - VEML6075 Test Set-Up Using a White LED as Light Source

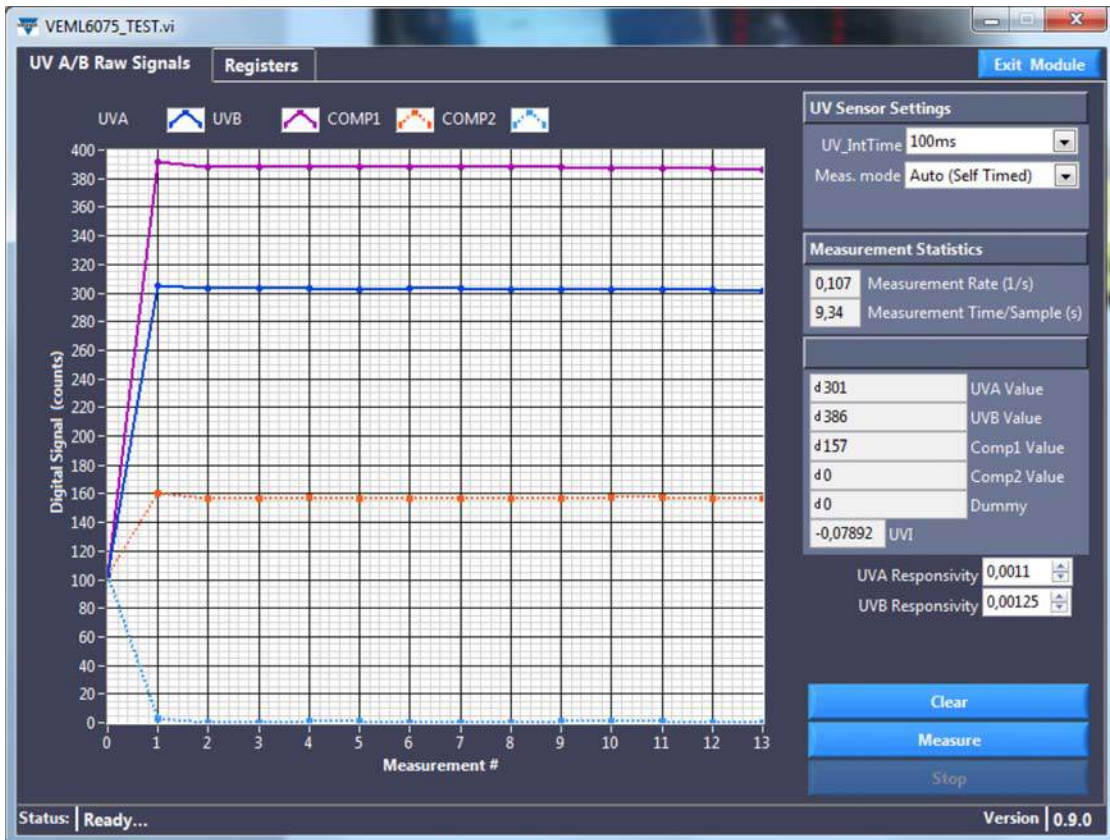

Fig. 9 - VEML6075 Demo Software View When Light Source Used a White LED

Designing the VEML6075 Into an Application



Fig. 10 - VEML6075 Test Set-Up Using an Incandescent Lamp as Light Source

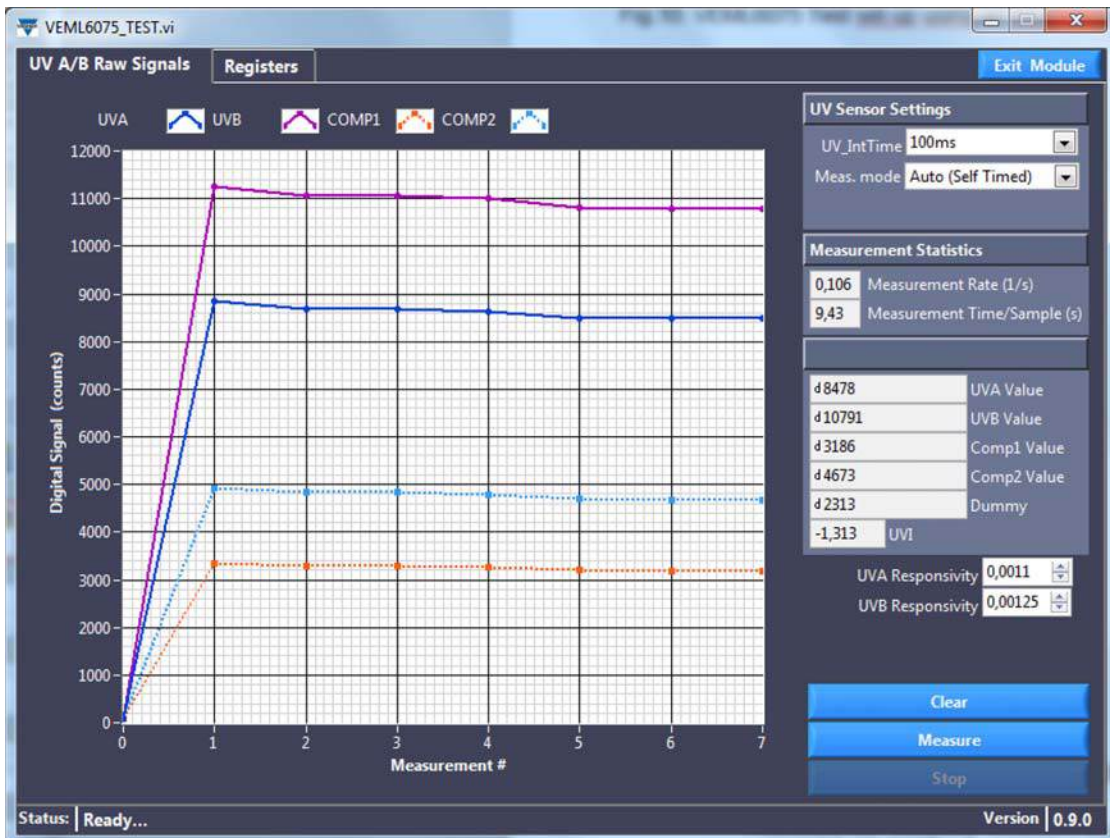

Fig. 11 - VEML6075 Demo Software View When Light Source Used an Incandescent Lamp



Designing the VEML6075 Into an Application

To calculate visible light coefficients a and c, use a WLED since $UV_{comp2} = 0$, because a white LED delivers no infrared signal, so $d \times (UV_{comp2}) = 0$.

$$UVB_{calc} = UVB - (c \times UV_{comp1}) - (d \times UV_{comp2}) = 0 \tag{Eq. (7)}$$

$$UVB = c \times UV_{comp1}$$

$$c = \frac{UVB}{UV_{comp1}}$$

UVB data is measured to: **386**, UV_{comp1} data is measured to: **157**.

UVB visible coefficient **c = 386/157 = 2.46**.

$$UVA_{calc} = UVA - (a \times UV_{comp1}) - (b \times UV_{comp2}) = 0 \tag{Eq. (6)}$$

$$UVA = a \times UV_{comp1}$$

$$a = \frac{UVA}{UV_{comp1}}$$

UVA data is measured to: **301**, UV_{comp1} data is measured to: **157**.

UVA visible coefficient **a = 301/157 = 1.92**.

To calculate IR coefficients b and d, use a 2700 K, 60 W incandescent light to record the raw data.

$$\text{Using } c = 2.46 \text{ and } d = \frac{UVB - (c \times UV_{comp1})}{UV_{comp2}}$$

UVB infrared coefficient, **d = (10 791 - (2.46 x 3186))/4673 = 0.63**

$$\text{Using } a = 1.92 \text{ and } b = \frac{UVA - (a \times UV_{comp1})}{UV_{comp2}}$$

UVA infrared coefficient, **b = (8478 - (1.92 x 3186))/4673 = 0.55**

Note

- For exact coefficients with sun light and different kind of cover please see page 15.

Designing the VEML6075 Into an Application

CALCULATING THE UV INDEX

Calculation of the UVI is quite complex. Not only does every wavelength between 286.5 nm and 400 nm need to be measured - in steps of 0.5 nm - but a weighting function also needs to be applied.

The UV index is defined as:
$$UVI = \frac{1}{25 \frac{mW}{m^2}} \int_{286.5 \text{ nm}}^{400 \text{ nm}} I(\lambda) \times w(\lambda) \times d(\lambda),$$

where the weighting function for erythema is given as:

$$w(\lambda) = \begin{cases} 1 & 250 < \lambda \leq 298 \\ 10^{0.094 \times (298 - \lambda)} & 298 < \lambda \leq 328 \\ 10^{0.015 \times (139 - \lambda)} & 328 < \lambda \leq 400 \\ 0 & 400 < \lambda \end{cases}$$

after A. F. McKinlay and B. L. Diffey (1987)

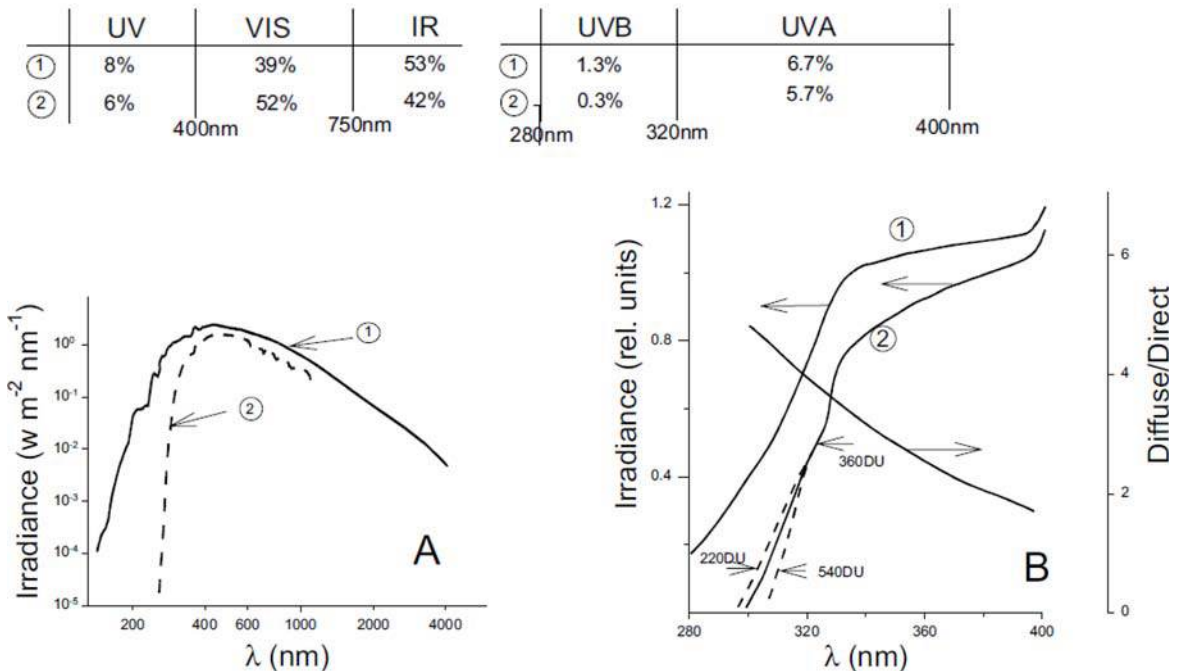

Fig. 12 - Spectrum of Solar Radiation: Outside the Atmosphere (1) and at Sea Level (2)

Designing the VEML6075 Into an Application

WHAT VALUES MAY BE SEEN WITH THE VEML6075

The defined UV light source also shown within the datasheet (Nichia NCSU033X-365 nm) to check UVA sensitivity and the 315 nm UVTOP310TO39HS to verify UVB sensitivity will not be available within most labs. In addition, the set-up with the before-mentioned white LED and incandescent lamp needs accuracy and an alignment to deliver comparable results.

Even “normal” daylight to study and compare the VEML6075’s response may lead to misinterpretation, as the UV power is strongly dependent on the time of day, season, and location where the measurement will be made.

During winter times, the total skin-affecting irradiance may be so low that even within full sunshine no remarkable values will be seen.

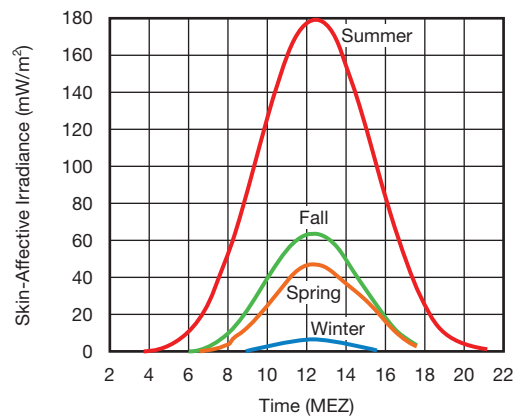

Fig. 13 - Skin-Affecting Irradiance Level vs. Time Seen at the Beginning of the Four Seasons

The correct UV index needs a well-calibrated measurement tool, such as the Davis weather station used to calibrate the VEML6075. This so-called “golden sample” may then be taken as reference.

Designing the VEML6075 Into an Application

WHAT VALUES ARE MEASURED WITH THE VEML6075

Placing the sensor AND the reference measurement tool (e.g. Davis 6490 UVI sensor) in an open area over the whole day shows the exact performance of the VEML6075.

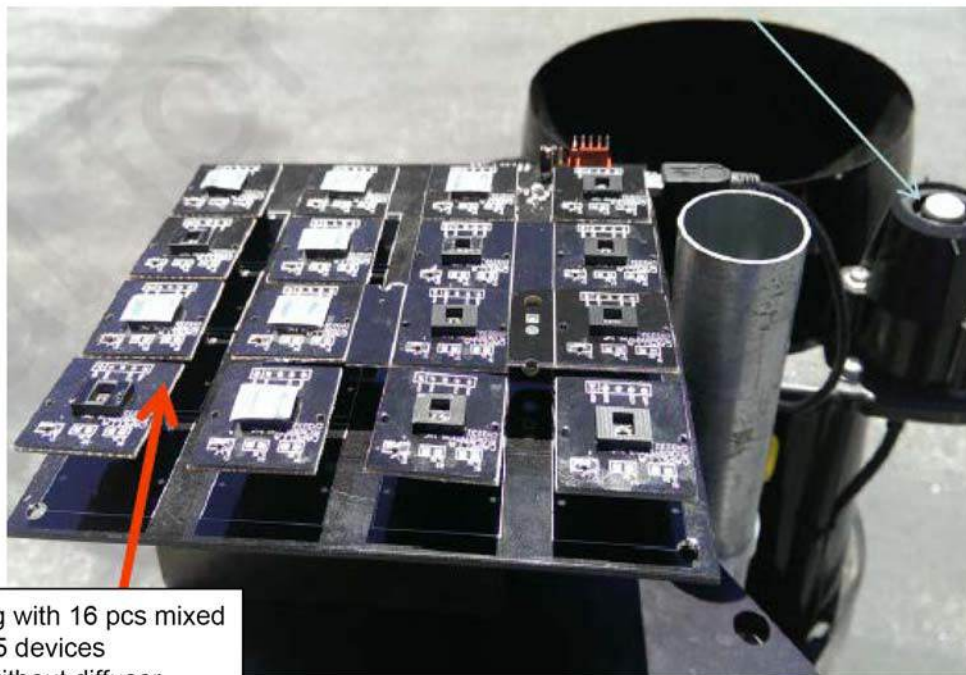

UVI testing with 16 pcs mixed VEML6075 devices with and without diffuser

Fig. 14 - Measurement Set-Up

Designing the VEML6075 Into an Application

Below, full-day UVI tracking with the Davis UVI sensor and T148 with no diffuser is shown. The maximum UVI is 9.7.

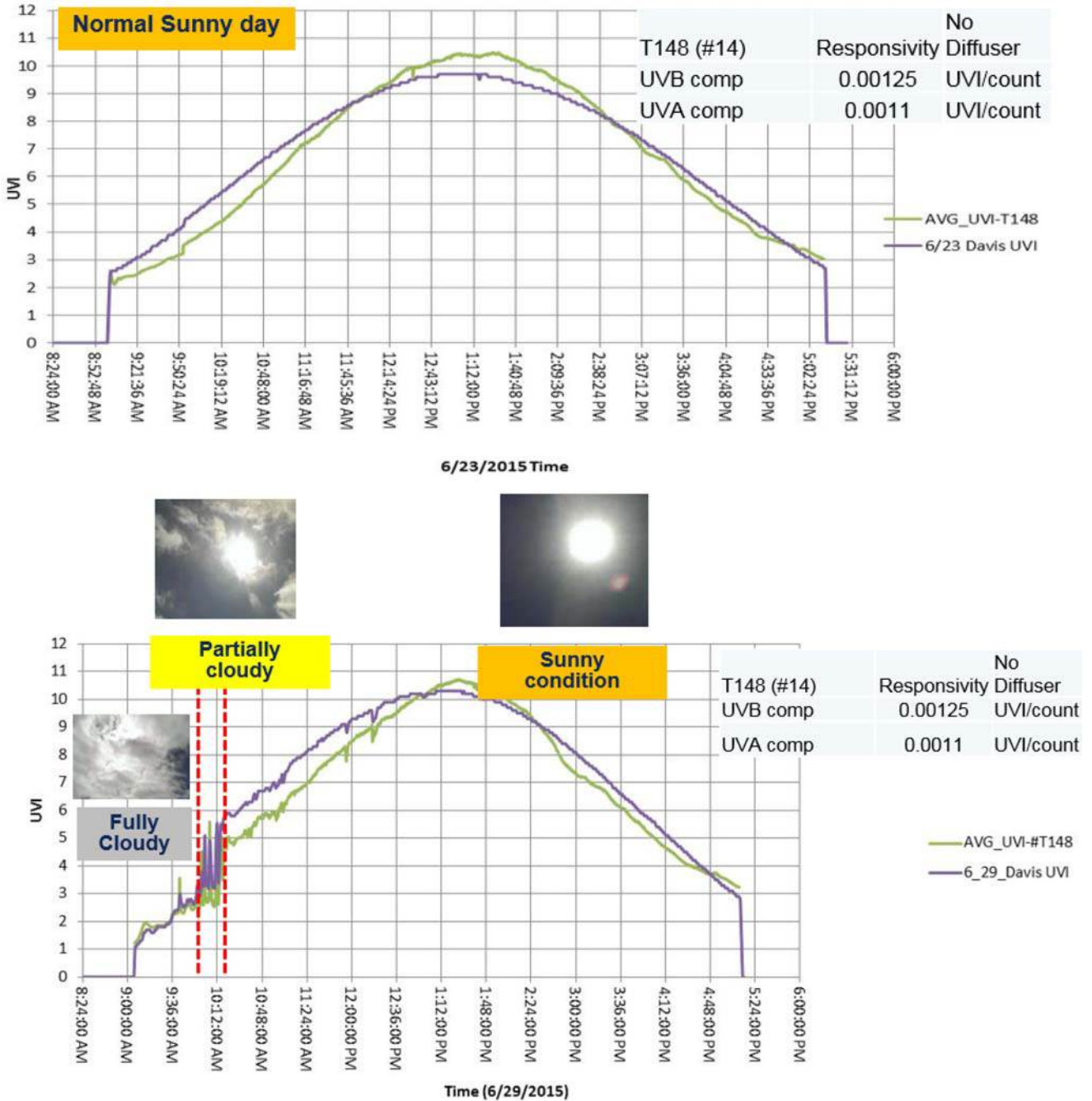

Fig. 15 - Test Data Showing Calculated UVI and Comparison to Reference

With the empirical findings of the coefficients and comparable measured UV responsivity, the exact UVI is seen.

Designing the VEML6075 Into an Application

UV COEFFICIENTS AND RESPONSIVITY						
	a	b	c	d	UVA _{resp}	UVB _{resp}
No teflon (open air)	2.22	1.33	2.95	1.74	0.001461	0.002591
0.1 mm teflon 4.5 mm window	2.22	1.33	2.95	1.74	0.002303	0.004686
0.1 mm teflon 5.5 mm window	2.22	1.33	2.95	1.74	0.002216	0.005188
0.1 mm teflon 10 mm window	2.22	1.33	2.95	1.74	0.002681	0.004875
0.25 mm teflon 10 mm window	2.22	1.33	2.95	1.74	0.002919	0.009389
0.4 mm teflon 10 mm window	2.22	1.17	2.95	1.58	0.004770	0.006135
0.7 mm teflon 10 mm window	2.22	1.17	2.95	1.58	0.007923	0.008334
1.0 mm teflon 5.5 mm window	2.55	1.00	3.80	1.10	0.006000	0.003100

For responsivity without a diffusor and IT = 100 ms:

UVA sensing resolution of 0.01 UVI = 9 counts

UVB sensing resolution of 0.01 UVI = 8 counts

MECHANICAL CONSIDERATIONS AND WINDOW CALCULATIONS FOR THE VEML6075

As already mentioned, this UVA / UVB sensor will need a well-selected cover that is not only completely transmissive to visible light (400 nm to 700 nm), but also to UVA and UVB wavelengths (280 nm to 400 nm) and up to near infrared wavelengths from 700 nm to 1000 nm.

Teflon or polytetrafluoroethylene (PTFE) is a known optical material that allows transmission of UV up to near infrared signals. A teflon diffusor (PTFE sheet) radiates like Lambert's cosine law. Thus PTFE enables a cosine angular response for a detector measuring the optical radiation power at a surface.

Using a 0.4 mm thin teflon diffusor placed on top of the VEML6075 sensor generates a very close to cosine view angle response. Compared with the ideal cosine response, the measured view angle response error of a 0.4 mm teflon diffusor is less than 10 %.

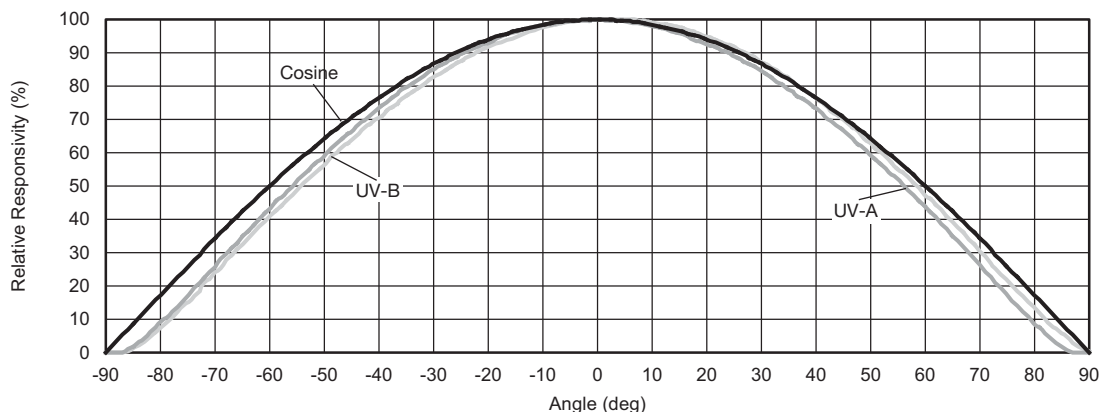

Fig. 16 - Relative Radiant Sensitivity vs. Angular Displacement

For more information please also see:

www.muybien.com.tw

www.berghof.com/en/products/ptfe-products/optical-ptfe/

www.aetnaplastics.com/site_media/media/documents/Acrylic OP-4 Material Data Sheet.pdf

Designing the VEML6075 Into an Application

For optimal performance, the window size should be large enough to maximize the light irradiating the sensor but also not that wide that sun light under low angle could reach the chip edges below the filter. In calculating the window size, the only dimensions that the design engineer needs to consider are the distance from the top surface of the sensor to the outside surface of the window and the size of the window. These dimensions will determine the size of the detection zone.

First, the center of the sensor and center of the window should be aligned. The VEML6075 has an angle of half sensitivity of about $\pm 55^\circ$, as shown in the figure below.

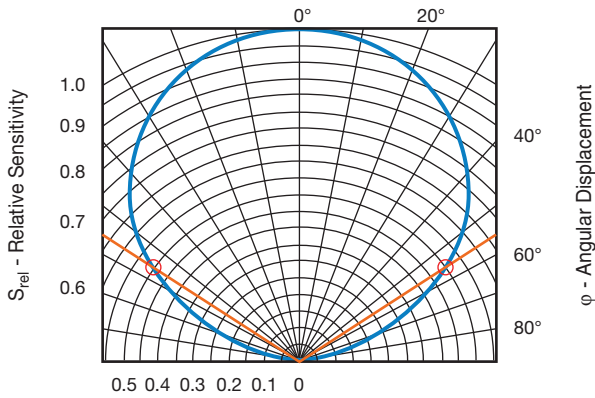

Fig. 17 - Relative Radiant Sensitivity vs. Angular Displacement

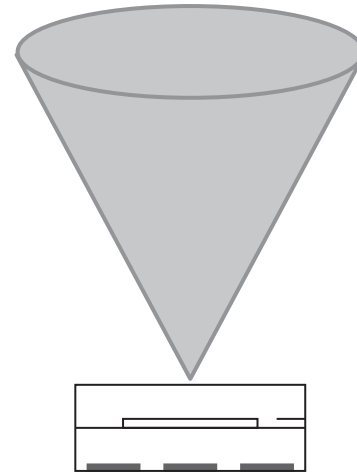

Fig. 18 - Angle of Half Sensitivity: Cone

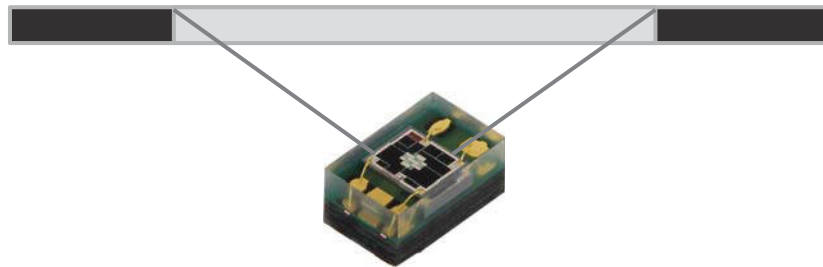

Fig. 19 - Window Above Sensitive Area

Remark:

This wide angle and the placement of the sensor as close as possible to the cover is needed to show good responsivity. A quite dark (black) PCB should be used to avoid reflections from PCB towards sides of the sensor.

Designing the VEML6075 Into an Application

The size of the window is simply calculated according to triangular rules. The dimensions of the device, as well as the sensitive area, are shown within the datasheet. For best results, the distance below the window's upper surface and the specified angle below the given window diameter (w) are known.

The window should be quite small not to allow also light reaching sensors edges, but wide enough to receive light from straight up to an angle of about $\pm 40^\circ$.

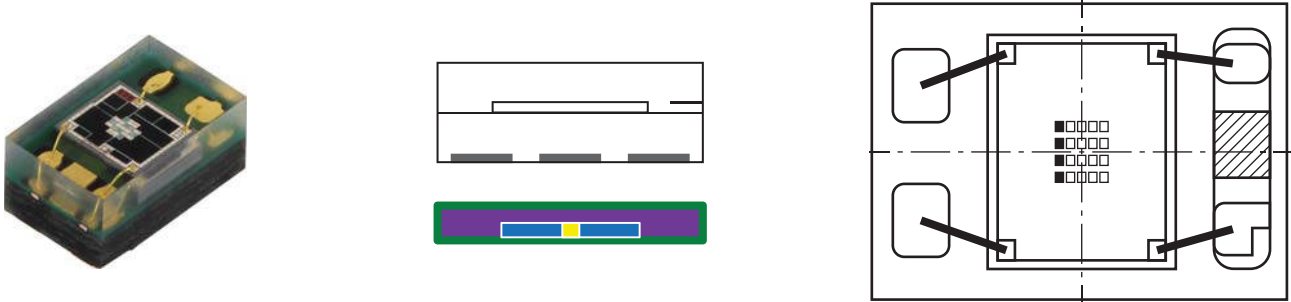

Dimensions (L x W x H in mm): 2.0 x 1.25 x 1.0

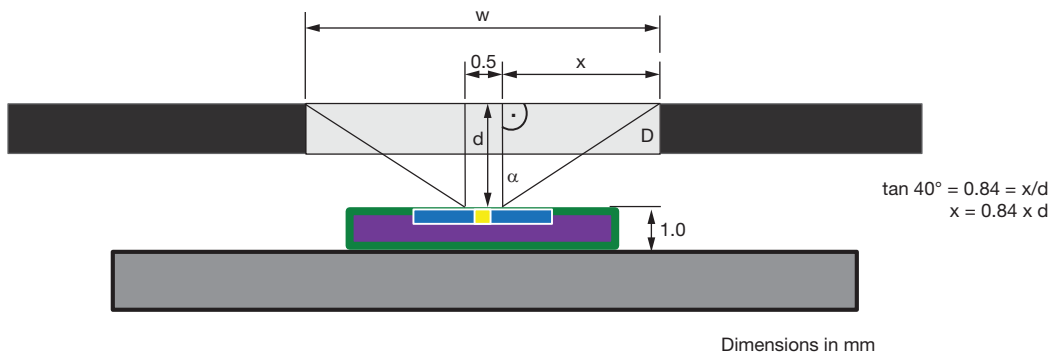

Fig. 20 - Window Area for an Opening Angle of $\pm 40^\circ$

The calculation is then: $\tan \alpha = x/d \rightarrow$ with $\alpha = 40^\circ$ and $\tan 40^\circ 0.84 = x/d \rightarrow x = 0.84 \times d$.
Then the total width is $w = 0.5 \text{ mm} + 2 \times x$.

$d = 0.5 \text{ mm}$	\rightarrow	$x = 0.42 \text{ mm}$	\rightarrow	$w = 0.5 \text{ mm} + 0.84 \text{ mm}$	$=$	1.34 mm
$d = 1.0 \text{ mm}$	\rightarrow	$x = 0.84 \text{ mm}$	\rightarrow	$w = 0.5 \text{ mm} + 1.68 \text{ mm}$	$=$	2.18 mm
$d = 1.5 \text{ mm}$	\rightarrow	$x = 1.28 \text{ mm}$	\rightarrow	$w = 0.5 \text{ mm} + 2.56 \text{ mm}$	$=$	3.06 mm
$d = 2.0 \text{ mm}$	\rightarrow	$x = 1.68 \text{ mm}$	\rightarrow	$w = 0.5 \text{ mm} + 3.36 \text{ mm}$	$=$	3.86 mm



Designing the VEML6075 Into an Application

VEML6075 REFERENCE CODE

```

/* VEML6075 slave address */
#define VEML6075_ADDR                0x20 // 7-bit: 0x10

/* Registers define */
#define VEML6075_CONF_REG            0x00
#define VEML6075_UVA_DATA_REG        0x07
#define VEML6075_UVB_DATA_REG        0x09
#define VEML6075_UVCOMP1_DATA_REG    0x0A
#define VEML6075_UVCOMP2_DATA_REG    0x0B
#define VEML6075_ID_REG               0x0C

/* Register value define : CONF */
#define VEML6075_CONF_SD              0x01
#define VEML6075_CONF_UV_AF_AUTO      0x00
#define VEML6075_CONF_UV_AF_FORCE    0x02
#define VEML6075_CONF_UV_TRIG_NO     0x00
#define VEML6075_CONF_UV_TRIG_ONCE   0x04
#define VEML6075_CONF_HD              0x08
#define VEML6075_CONF_UV_IT_MASK     0x70
#define VEML6075_CONF_UV_IT_50MS     0x00
#define VEML6075_CONF_UV_IT_100MS    0x10
#define VEML6075_CONF_UV_IT_200MS    0x20
#define VEML6075_CONF_UV_IT_400MS    0x30
#define VEML6075_CONF_UV_IT_800MS    0x40
#define VEML6075_CONF_DEFAULT         (VEML6075_CONF_UV_AF_AUTO | ;
                                       VEML6075_CONF_UV_TRIG_NO | ;
                                       VEML6075_CONF_UV_IT_100MS)

/* I2C message, used for I2C transaction */
struct i2c_msg {
    WORD addr;
    WORD flags;
#define I2C_M_TEN                      0x0010
#define I2C_M_RD                       0x0001
#define I2C_M_NOSTART                  0x4000
#define I2C_M_REV_DIR_ADDR            0x2000
#define I2C_M_IGNORE_NAK              0x1000
#define I2C_M_NO_RD_ACK               0x0800
#define I2C_M_RECV_LEN                 0x0400
    WORD len;
    BYTE *buf;
};

extern int i2c_transfer(struct i2c_msg *msgs, int num);

/*-----
C main function
-----*/

void main(void)
{
    WORD VEML6075_conf;
    WORD uva_data;
    WORD uvb_data;
    WORD uvcomp1_data;

```



Designing the VEML6075 Into an Application

VEML6075 REFERENCE CODE (continued)

```
/* Shut down VEML6075 */
VEML6075_conf = VEML6075_CONF_DEFAULT | VEML6075_CONF_SD;
VEML6075_write_word(VEML6075_ADDR, VEML6075_CONF_REG, VEML6075_conf);

/* Enable VEML6075 */
VEML6075_conf = VEML6075_CONF_DEFAULT;
VEML6075_write_word(VEML6075_ADDR, VEML6075_CONF_REG, VEML6075_conf);

/* Loop for polling VEML6075 data */
while (1)
{
    delay(150);

    VEML6075_read_word(VEML6075_ADDR, VEML6075_UVA_DATA_REG, &uva_data);
    VEML6075_read_word(VEML6075_ADDR, VEML6075_UVB_DATA_REG, &uvb_data);
    VEML6075_read_word(VEML6075_ADDR, VEML6075_UVCOMP1_DATA_REG,
&uvcomp1_data);
    VEML6075_read_word(VEML6075_ADDR, VEML6075_UVCOMP2_DATA_REG,
&uvcomp2_data);
}
}

int VEML6075_read_word(WORD addr, BYTE reg, WORD *val)
{
    int err = 0;
    int retry = 3;
    struct i2c_msg msg[2];
    BYTE data[2];

    while (retry--)
    {
        /* Send slave address & register */
        msg[0].addr = addr >> 1;
        msg[0].flags = I2C_M_WR;
        msg[0].len = 1;
        msg[0].buf = &reg;

        /* Read word data */
        msg[1].addr = addr >> 1;
        msg[1].flags = I2C_M_RD;
        msg[1].len = 2;
        msg[1].buf = data;

        err = i2c_transfer(msg, 2);

        if (err >= 0)
        {
            *val = ((WORD)data[1] << 8) | (WORD)data[0];
            return err;
        }
    }

    return err;
}
```



Designing the VEML6075 Into an Application

VEML6075 REFERENCE CODE (continued)

```
int VEML6075_write_word(WORD addr, BYTE reg, WORD val)
{
    int err = 0;
    int retry = 3;
    struct i2c_msg msg;
    BYTE data[3];

    while (retry--)
    {
        data[0] = reg;
        data[1] = (BYTE)(val & 0xFF);
        data[2] = (BYTE)((val & 0xFF00) >> 8);

        /* Send slave address, register and word data */
        msg.addr = addr >> 1;
        msg.flags = I2C_M_WR;
        msg.len = 3;
        msg.buf = data;

        err = i2c_transfer(msg, 1);

        if (err >= 0)
            return 0;
    }

    return err;
}
```

VEML6075 SENSOR BOARD AND DEMO SOFTWARE

The small black VEML6075 sensor board fits to the so-called SensorXplorer™. With this sensor board an additional tiny small aperture PCB is delivered having a teflon diffuser plugged in.

Please also see: www.vishay.com/optoelectronics/SensorXplorer.

With help of the VEML6075 sensor board and the demo software, one can easily test this UVA / UVB sensor. Beside the raw data of all five channels, the UV index is also given with the calculations shown before. The five integration times are also selectable. The resulting counts are strictly linear, meaning a factor of 2 in integration time also results in a factor of 2 in output data counts.

Designing the VEML6075 Into an Application

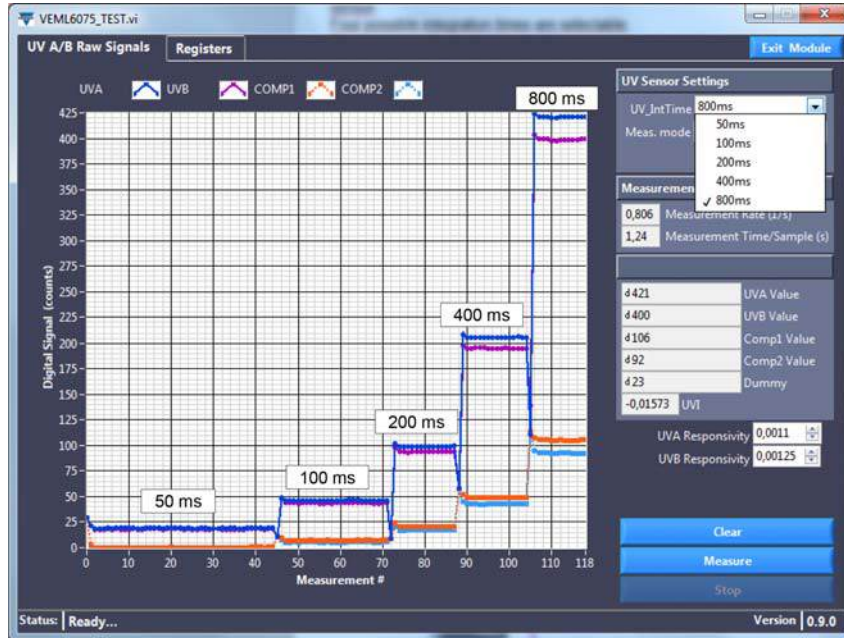

Fig. 21 - Linearity of Integration Times for Small and High Data Values

Beside the raw data read out of command codes 0x07 and 0x09, the corresponding UV index is also shown, as well as the risk level indicated with changing the color according to Fig. 6.

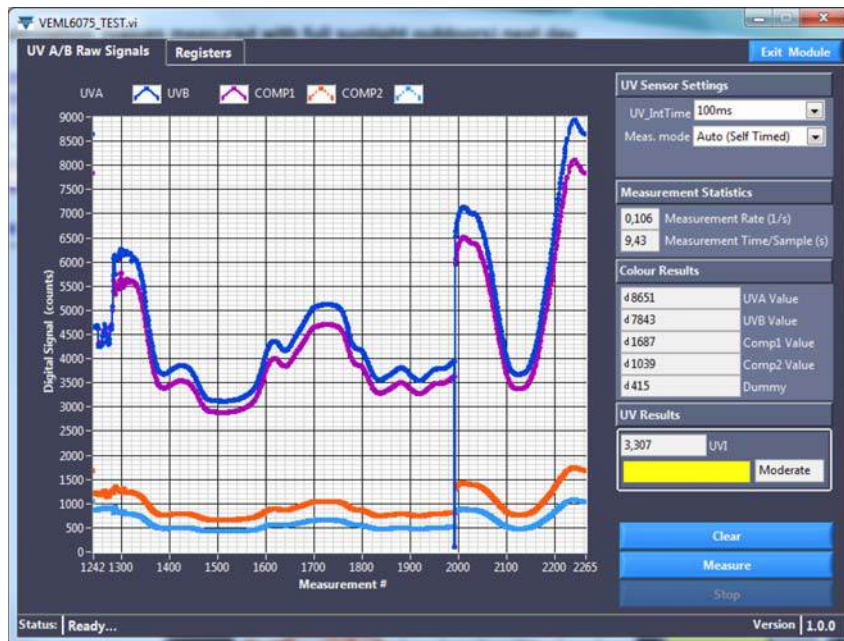

Fig. 22 - View of the VEML6075 Demo Software Showing Raw Data, UVI, and Risk Level