

Optocoupler, Phototransistor Output, Low Input Current, SOP-4, Mini-Flat Package

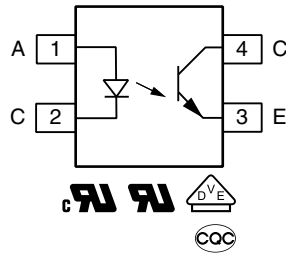

FEATURES

- AEC-Q102 qualified
- High CTR with low input current
- SOP-4 low profile package
- High collector emitter voltage, $V_{CEO} = 80\text{ V}$
- Isolation test voltage = 3750 V_{RMS}
- Low coupling capacitance
- Material categorization: for definitions of compliance please see www.vishay.com/doc?99912

AUTOMOTIVE GRADE

RoHS
 COMPLIANT
 HALOGEN
FREE
GREEN
 (5-2008)

LINKS TO ADDITIONAL RESOURCES



DESCRIPTION

The VOMA617A series has a GaAlAs infrared emitting diode, which is optically coupled to a silicon planar phototransistor detector, and is incorporated in a 4-pin mini-flat package.

It features a high current transfer ratio at low input current, low coupling capacitance, and high isolation voltage.

The coupling devices are designed for signal transmission between two electrically separated circuits, specifically for use in automotive, as well as high reliable industrial applications.

APPLICATIONS

- Galvanic and noise isolation
- Signal transmission
- Hybrid / electric vehicle applications
- Battery management
- 48 V board net
- System control

AGENCY APPROVALS

- [UL1577](#)
- [cUL 1577](#)
- [DIN EN 60747-5-5 \(VDE 0884-5\)](#)
- [CQC GB4943.1-2011](#)

ORDERING INFORMATION															
V	O	M	A	6	1	7	A	-	#	X	0	0	1	T	
PART NUMBER								CTR BIN	PACKAGE OPTION			TAPE AND REEL			
AGENCY CERTIFIED / PACKAGE					CTR (%)										
					5 mA										
UL, cUL, VDE, CQC					50 to 600	100 to 200	160 to 320								
SOP-4					VOMA617A-X001T	VOMA617A-3X001T	VOMA617A-4X001T								

Note

- Additional options may be possible, please contact sales office



ABSOLUTE MAXIMUM RATINGS ($T_{amb} = 25\text{ }^{\circ}\text{C}$, unless otherwise specified)				
PARAMETER	TEST CONDITION	SYMBOL	VALUE	UNIT
INPUT				
Reverse voltage		V_R	5	V
Power dissipation		P_{diss}	30	mW
Forward current		I_F	20	mA
Surge forward current	$t_p \leq 10\text{ }\mu\text{s}$	I_{FSM}	0.5	A
Junction temperature		T_j	125	$^{\circ}\text{C}$
OUTPUT				
Collector emitter voltage		V_{CEO}	80	V
Emitter collector voltage		V_{ECO}	7	V
Collector current		I_C	50	mA
Power dissipation		P_{diss}	150	mW
Junction temperature		T_j	125	$^{\circ}\text{C}$
COUPLER				
Total power dissipation		P_{tot}	180	mW
Storage temperature range		T_{stg}	-40 to +150	$^{\circ}\text{C}$
Ambient temperature range		T_{amb}	-40 to +110	$^{\circ}\text{C}$
Soldering temperature	$t = 10\text{ s}$	T_{sld}	260	$^{\circ}\text{C}$

Note

- Stresses in excess of the absolute maximum ratings can cause permanent damage to the device. Functional operation of the device is not implied at these or any other conditions in excess of those given in the operational sections of this document. Exposure to absolute maximum ratings for extended periods of the time can adversely affect reliability

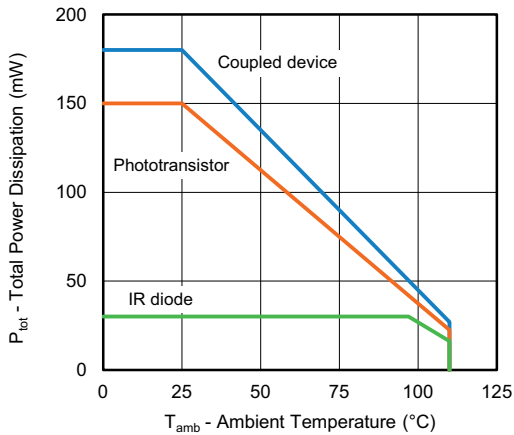

Fig. 1 - Power Dissipation vs. Ambient Temperature

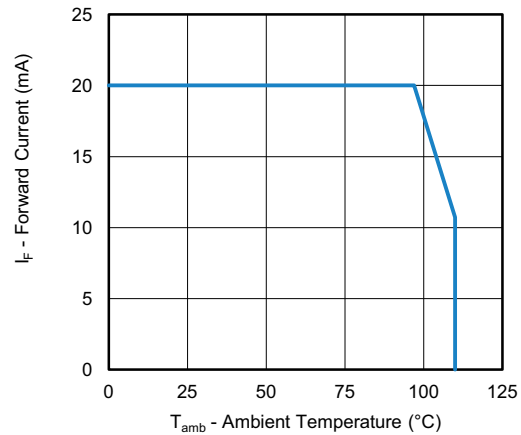

Fig. 2 - Maximum Forward Current vs. Ambient Temperature



ELECTRICAL CHARACTERISTICS ($T_{amb} = 25\text{ }^{\circ}\text{C}$, unless otherwise specified)						
PARAMETER	TEST CONDITION	SYMBOL	MIN.	TYP.	MAX.	UNIT
INPUT						
Forward voltage	$I_F = 5\text{ mA}$	V_F	-	1.33	1.5	V
Reverse current	$V_R = 5\text{ V}$	I_R	-	-	10	μA
Capacitance	$V_R = 0\text{ V}$, $f = 1\text{ MHz}$	C_I	-	40	-	pF
Thermal resistance		R_{thJA}	-	1000	-	K/W
OUTPUT						
Collector emitter leakage current	$V_{CE} = 50\text{ V}$	I_{CEO}	-	1	100	nA
Collector emitter breakdown voltage	$I_C = 100\text{ }\mu\text{A}$	BV_{CEO}	80	-	-	V
Collector emitter capacitance	$V_{CE} = 5\text{ V}$, $f = 1\text{ MHz}$	C_{CE}	-	7	-	pF
Thermal resistance		R_{thJA}	-	667	-	K/W
COUPLER						
Collector emitter saturation voltage	$I_F = 5\text{ mA}$, $I_C = 1.25\text{ mA}$	V_{CEsat}	-	0.25	0.4	V
Cut-off frequency	$I_F = 10\text{ mA}$, $V_{CC} = 5\text{ V}$, $R_L = 100\text{ }\Omega$	f_{CTR}	-	165	-	kHz
Coupling capacitance	$f = 1\text{ MHz}$	C_{IO}	-	1.2	-	pF
Thermal resistance		R_{thJA}	-	556	-	K/W

Note

- Minimum and maximum values are testing requirements. Typical values are characteristics of the device and are the result of engineering evaluation. Typical values are for information only and are not part of the testing requirements

CURRENT TRANSFER RATIO ($T_{amb} = 25\text{ }^{\circ}\text{C}$, unless otherwise specified)							
PARAMETER	TEST CONDITION	PART	SYMBOL	MIN.	TYP.	MAX.	UNIT
I_C/I_F	$I_F = 5\text{ mA}$, $V_{CE} = 5\text{ V}$	VOMA617A	CTR	50	-	600	%
		VOMA617A-3	CTR	100	-	200	%
		VOMA617A-4	CTR	160	-	320	%
		VOMA617A-8	CTR	130	-	260	%

SWITCHING CHARACTERISTICS ($T_{amb} = 25\text{ }^{\circ}\text{C}$, unless otherwise specified)						
PARAMETER	TEST CONDITION	SYMBOL	MIN.	TYP.	MAX.	UNIT
NON-SATURATED						
Rise time	$I_C = 2\text{ mA}$, $V_{CC} = 5\text{ V}$, $R_L = 100\text{ }\Omega$	t_r	-	1.8	-	μs
Fall time		t_f	-	2.2	-	μs
Turn-on time		t_{on}	-	2.5	-	μs
Turn-off time		t_{off}	-	3.0	-	μs
SATURATED						
Rise time	$I_F = 5\text{ mA}$, $V_{CC} = 5\text{ V}$, $R_L = 1.9\text{ k}\Omega$	t_r	-	1.2	-	μs
Fall time		t_f	-	5.7	-	μs
Turn-on time		t_{on}	-	1.7	-	μs
Turn-off time		t_{off}	-	11.2	-	μs

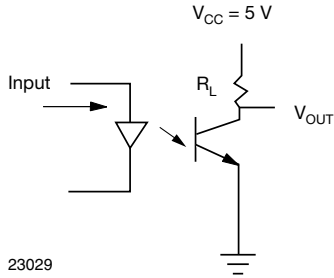

Fig. 3 - Test Circuit for Switching Characteristics

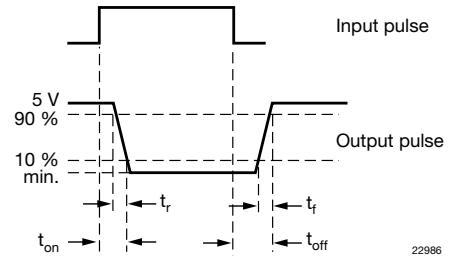

Fig. 4 - Parameter and Limit Definition

SAFETY AND INSULATION RATINGS				
PARAMETER	TEST CONDITION	SYMBOL	VALUE	UNIT
Climatic classification	According to IEC 68 part 1		40 / 110 / 21	
Pollution degree	According to DIN VDE 0109		2	
Comparative tracking index	Insulation group IIIa	CTI	175	
Maximum rated withstanding isolation voltage	According to UL1577, t = 1 min	V_{ISO}	3750	V_{RMS}
Maximum transient isolation voltage	According to DIN EN 60747-5-5	V_{IOTM}	6000	V_{peak}
Maximum repetitive peak isolation voltage	According to DIN EN 60747-5-5	V_{IORM}	707	V_{peak}
Isolation resistance	$T_{amb} = 25\text{ }^{\circ}\text{C}$, $V_{IO} = 500\text{ V}$	R_{IO}	$\geq 10^{12}$	Ω
	$T_{amb} = 100\text{ }^{\circ}\text{C}$, $V_{IO} = 500\text{ V}$	R_{IO}	$\geq 10^{11}$	Ω
	$T_{amb} = T_S$, $V_{IO} = 500\text{ V}$	R_{IO}	$\geq 10^9$	Ω
Output safety power		P_{SO}	550	mW
Input safety current		I_{SI}	180	mA
Input safety temperature		T_S	175	$^{\circ}\text{C}$
Creepage distance			≥ 5	mm
Clearance distance			≥ 5	mm

Note

- As per IEC 60747-5-5, § 5.5.4.9.3, this optocoupler is suitable for “safe electrical insulation” only within the safety ratings. Compliance with the safety ratings shall be ensured by means of protective circuits.

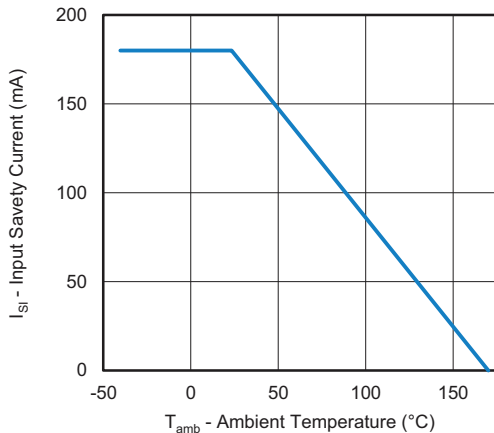

Fig. 5 - Input Safety Current vs. Ambient Temperature

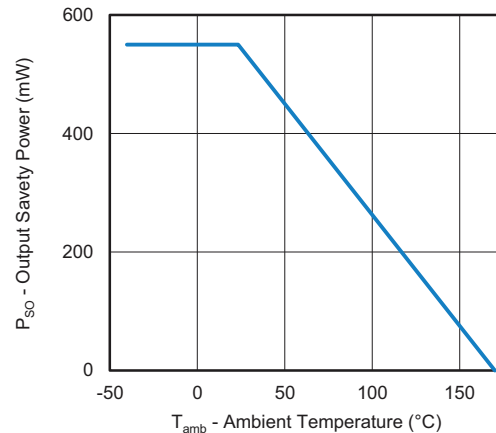

Fig. 6 - Output Safety Power vs. Ambient Temperature

TYPICAL CHARACTERISTICS ($T_{amb} = 25\text{ }^{\circ}\text{C}$, unless otherwise specified)

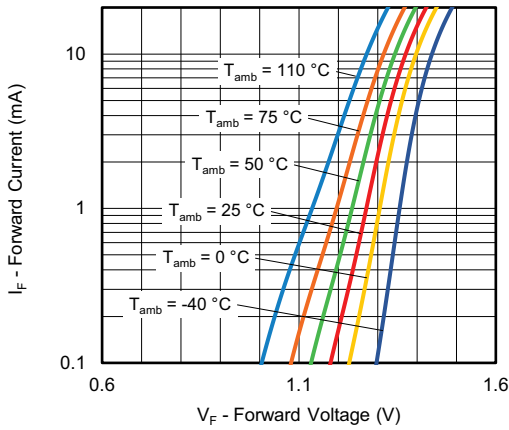

Fig. 7 - Forward Current vs. Forward Voltage

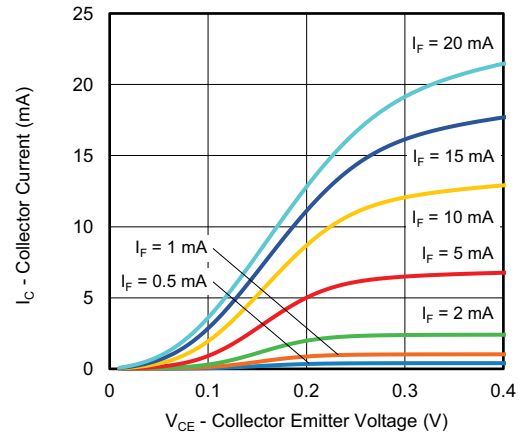

Fig. 10 - Collector Current vs. Collector Emitter Voltage (sat.)

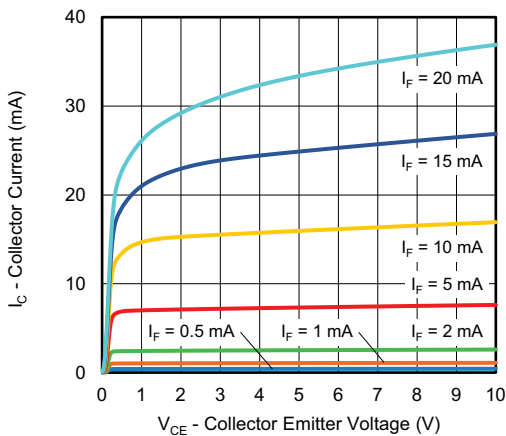

Fig. 8 - Collector Current vs. Collector Emitter Voltage (non-sat.)

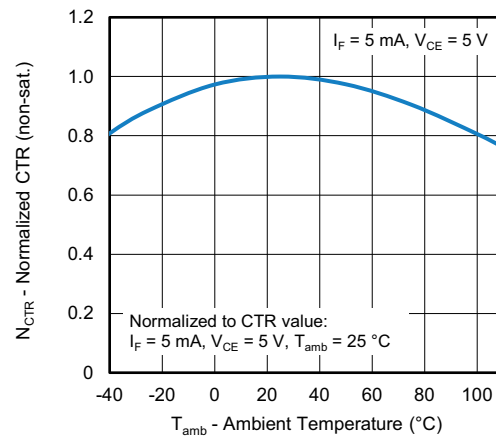

Fig. 11 - Normalized CTR (non-sat.) vs. Ambient Temperature

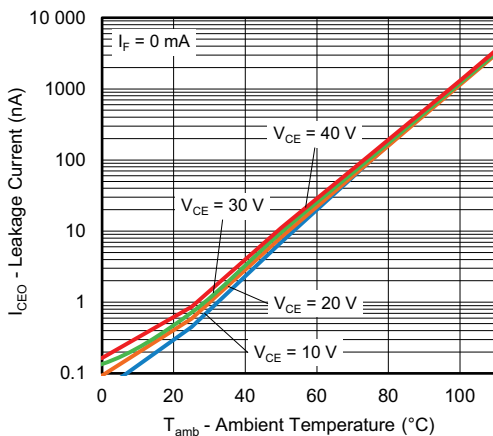

Fig. 9 - Leakage Current vs. Ambient Temperature

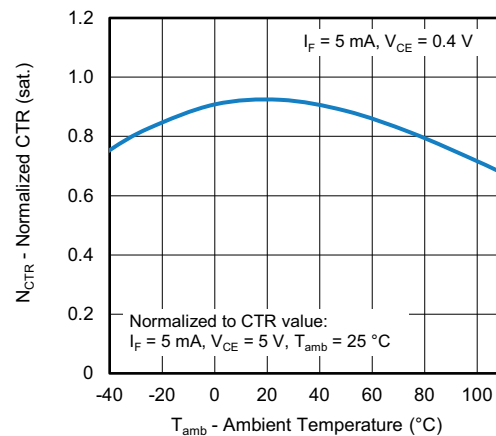

Fig. 12 - Normalized CTR (sat.) vs. Ambient Temperature

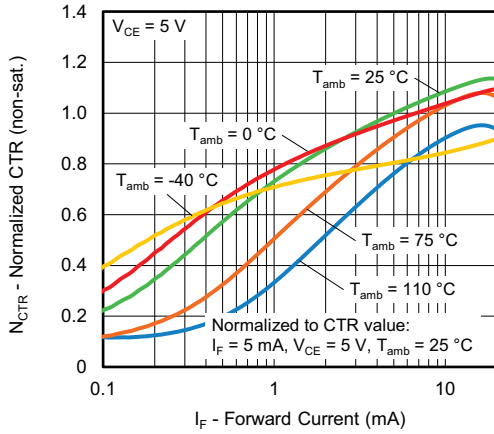

Fig. 13 - Normalized CTR (non-sat.) vs. Forward Current

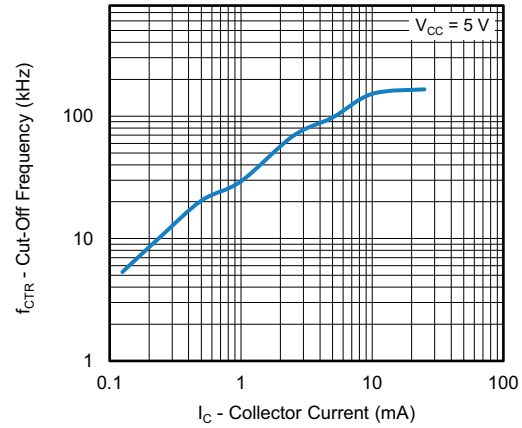

Fig. 16 - Cut-Off Frequency vs. Collector Current

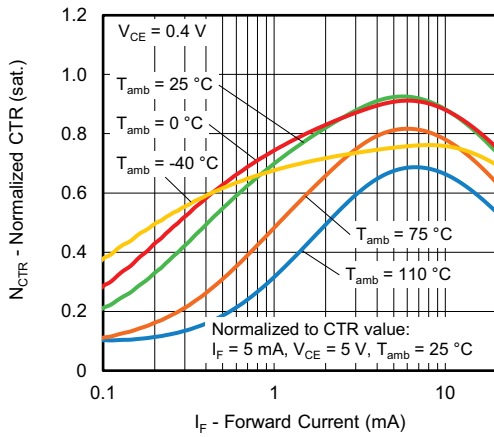

Fig. 14 - Normalized CTR (sat.) vs. Forward Current

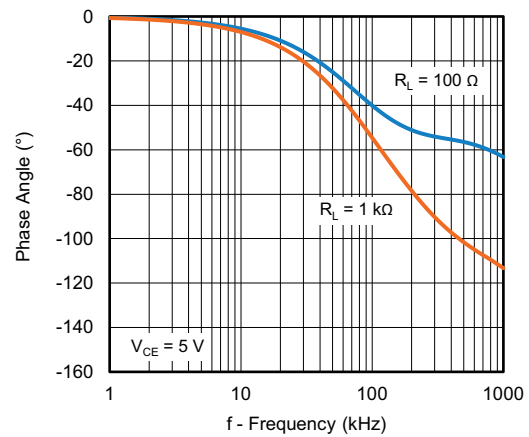

Fig. 17 - Phase Angle vs. Frequency

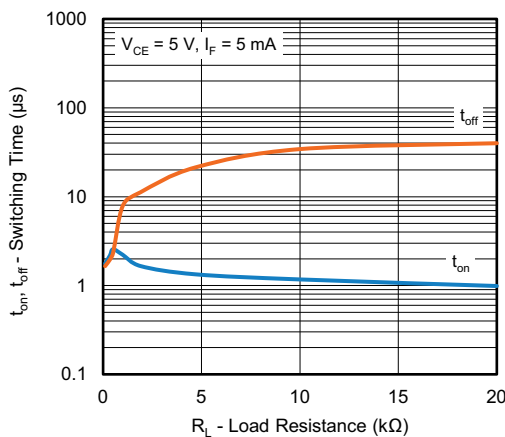

Fig. 15 - Switching Time vs. Load Resistance



PACKAGE DIMENSIONS (in millimeters)

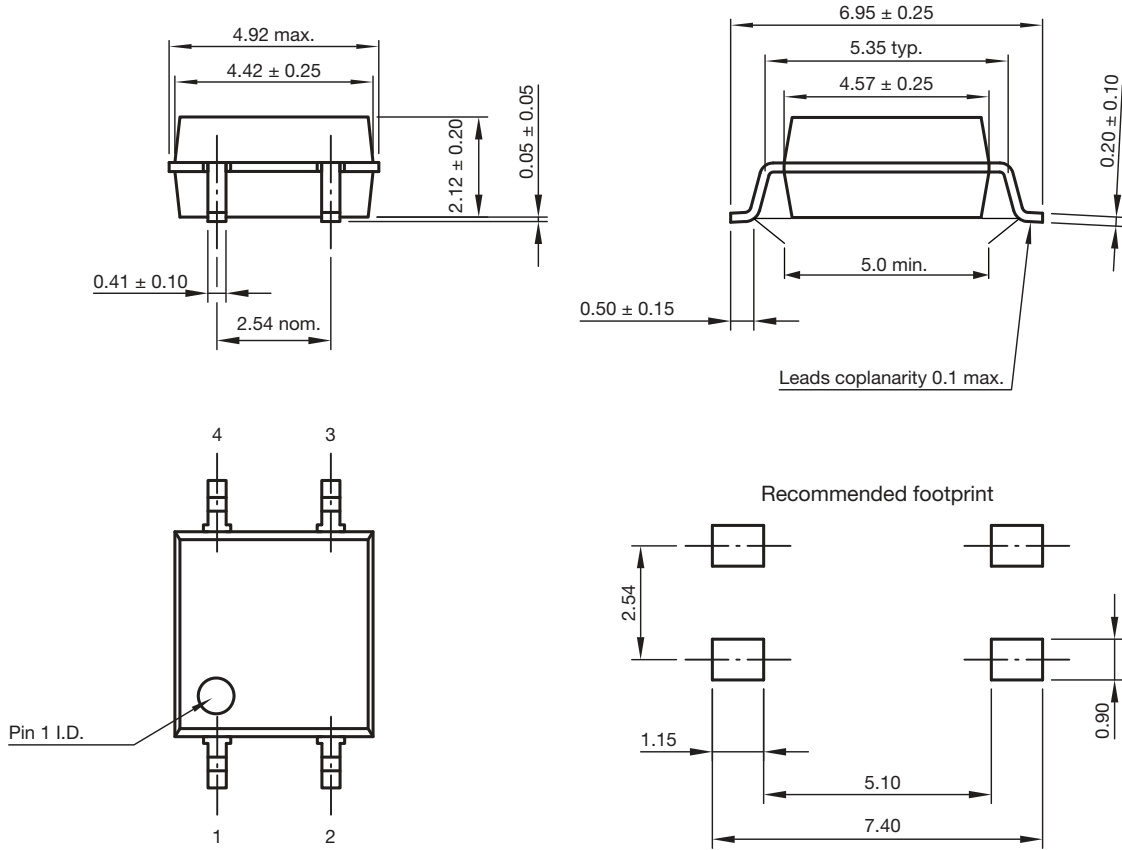
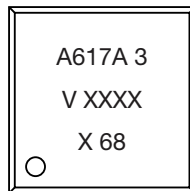

Fig. 18 - Package Drawing

PACKAGE MARKING (example of VOMA617A-3X001T)



Notes

- XXXX = LMC (lot marking code)
- Option 1 is reflected with letter "X"
- Tape and reel suffix (T) is not part of the package marking

PACKAGING INFORMATION (in millimeters)

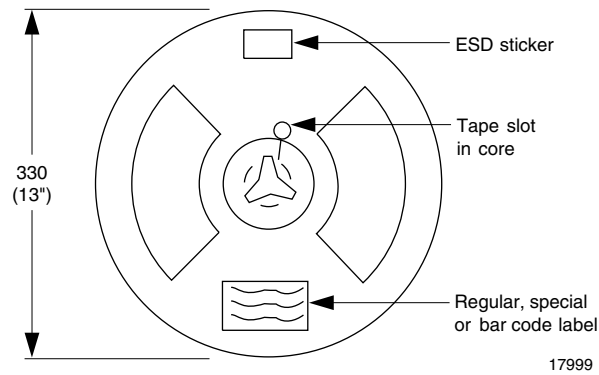
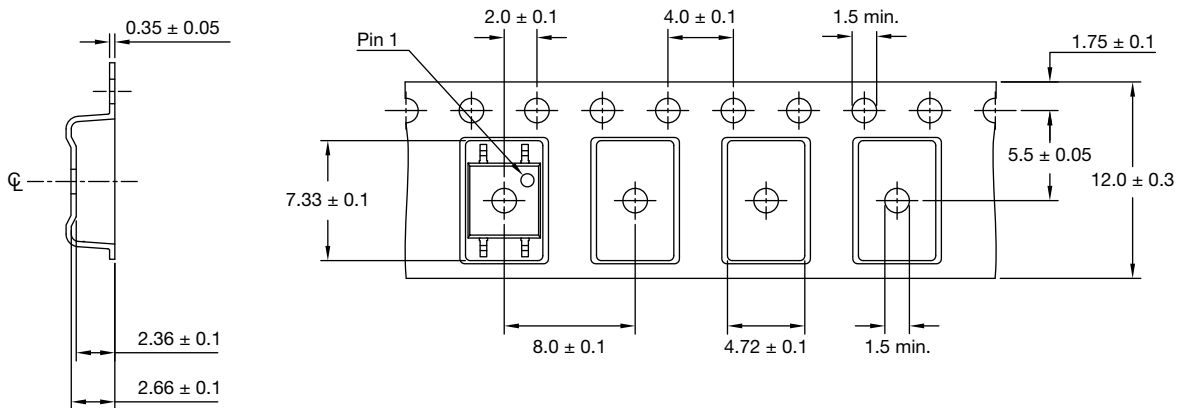

Fig. 19 - Tape and Reel Shipping Medium (EIA-481, revision A, and IEC 60286)



Note
 • Cummulative tolerance of 10 spocket holes is 0.20 mm

Fig. 20 - Tape and Reel Packing

TAPE AND REEL PACKING	
TYPE	UNITS/REEL
SOP-4	2000

SOLDER PROFILES

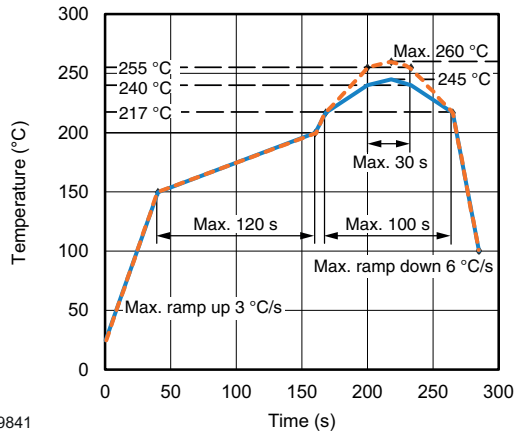

19841

Fig. 21 - Lead (Pb)-free Reflow Solder Profile According to J-STD-020 for SMD Devices

HANDLING AND STORAGE CONDITIONS

ESD level: HBM class 2

DRYPACK

Devices are packed in moisture barrier bags (MBB) to prevent the products from moisture absorption during transportation and storage. Each bag contains a desiccant.

FLOOR LIFE

Floor life (time between soldering and removing from MBB) must not exceed the time indicated on MBB label:

Floor life: 168 h

Conditions: $T_{amb} < 30\text{ °C}$, $RH < 60\%$

Moisture sensitivity level 3, according to J-STD-020.

DRYING

In case of moisture absorption devices should be baked before soldering. Conditions see J-STD-033D.



Disclaimer

ALL PRODUCT, PRODUCT SPECIFICATIONS AND DATA ARE SUBJECT TO CHANGE WITHOUT NOTICE TO IMPROVE RELIABILITY, FUNCTION OR DESIGN OR OTHERWISE.

Vishay Intertechnology, Inc., its affiliates, agents, and employees, and all persons acting on its or their behalf (collectively, "Vishay"), disclaim any and all liability for any errors, inaccuracies or incompleteness contained in any datasheet or in any other disclosure relating to any product.

Vishay makes no warranty, representation or guarantee regarding the suitability of the products for any particular purpose or the continuing production of any product. To the maximum extent permitted by applicable law, Vishay disclaims (i) any and all liability arising out of the application or use of any product, (ii) any and all liability, including without limitation special, consequential or incidental damages, and (iii) any and all implied warranties, including warranties of fitness for particular purpose, non-infringement and merchantability.

Statements regarding the suitability of products for certain types of applications are based on Vishay's knowledge of typical requirements that are often placed on Vishay products in generic applications. Such statements are not binding statements about the suitability of products for a particular application. It is the customer's responsibility to validate that a particular product with the properties described in the product specification is suitable for use in a particular application. Parameters provided in datasheets and / or specifications may vary in different applications and performance may vary over time. All operating parameters, including typical parameters, must be validated for each customer application by the customer's technical experts. Product specifications do not expand or otherwise modify Vishay's terms and conditions of purchase, including but not limited to the warranty expressed therein.

Hyperlinks included in this datasheet may direct users to third-party websites. These links are provided as a convenience and for informational purposes only. Inclusion of these hyperlinks does not constitute an endorsement or an approval by Vishay of any of the products, services or opinions of the corporation, organization or individual associated with the third-party website. Vishay disclaims any and all liability and bears no responsibility for the accuracy, legality or content of the third-party website or for that of subsequent links.

Vishay products are not designed for use in life-saving or life-sustaining applications or any application in which the failure of the Vishay product could result in personal injury or death unless specifically qualified in writing by Vishay. Customers using or selling Vishay products not expressly indicated for use in such applications do so at their own risk. Please contact authorized Vishay personnel to obtain written terms and conditions regarding products designed for such applications.

No license, express or implied, by estoppel or otherwise, to any intellectual property rights is granted by this document or by any conduct of Vishay. Product names and markings noted herein may be trademarks of their respective owners.