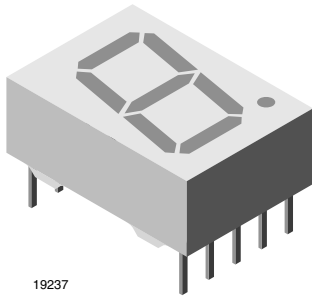


High Intensity Red Low Current 7-Segment Display



DESCRIPTION

This series defines a new standard for low current displays. It is a single digit 7-segment LED display utilizing AlInGaP technology in color red.

The supreme light intensity allows applications under direct sunlight or “black front” designs by using tinted filter glass in front of the display.

Typical 1500 μcd at 1 mA is best in class performance for applications with very limited power supply. The maximum forward current of 10 mA is allowed for an ambient temperature range of - 40 °C to + 85 °C without current derating.

Due to the design of 13 mm displays, a certain amount of cross-talk between segments is unavoidable. This light leakage becomes more noticeable as the brightness of the operated segments increases. However, higher environmental illumination, or a partially transparent cover, may reduce this effect. Therefore, it's important to consider this phenomenon during design-in and to validate suitability for the particular application and all its operation modes.

FEATURES

- 1500 μcd typical at 1 mA
- Very low power consumption
- Wide viewing angle
- Grey package surface
- Light intensity categorized at $I_F = 1 \text{ mA}$
- Material categorization: for definitions of compliance please see www.vishay.com/doc?99912


RoHS
COMPLIANT

APPLICATIONS

- Battery driven instruments
- Telecom devices
- Home appliances
- Instrumentation
- POS terminals

PRODUCT GROUP AND PACKAGE DATA

- Product group: display
- Package: 13 mm
- Product series: low current
- Angle of half intensity: $\pm 50^\circ$

PARTS TABLE

PART	COLOR	LUMINOUS INTENSITY (μcd)			at I_F (mA)	WAVELENGTH (nm)			at I_F (mA)	FORWARD VOLTAGE (V)			at I_F (mA)	CIRCUITRY
		MIN.	TYP.	MAX.		MIN.	TYP.	MAX.		MIN.	TYP.	MAX.		
TDSR1350	Red	280	-	3600	1	-	640	-	1	-	1.8	2.4	1	Common anode
TDSR1360	Red	280	-	3600	1	-	640	-	1	-	1.8	2.4	1	Common cathode
TDSR1360-IK	Red	1100	-	3600	1	-	640	-	1	-	1.8	2.4	1	Common cathode

ABSOLUTE MAXIMUM RATINGS ($T_{\text{amb}} = 25 \text{ }^\circ\text{C}$, unless otherwise specified)

TDSR1350, TDSR1360, TDSR1360-IK

PARAMETER	TEST CONDITION	SYMBOL	VALUE	UNIT
Reverse voltage per segment		V_R	5	V
DC forward current per segment		I_F	10	mA
Peak forward current per segment	$t_p \leq 10 \text{ } \mu\text{s}$, duty cycle 1/10	I_{FM}	50	mA
Power dissipation	$T_{\text{amb}} \leq 85 \text{ }^\circ\text{C}$	P_V	185	mW
Junction temperature		T_j	105	$^\circ\text{C}$
Operating temperature range		T_{amb}	-40 to +85	$^\circ\text{C}$
Storage temperature range		T_{stg}	-40 to +85	$^\circ\text{C}$
Soldering temperature	$t \leq 3 \text{ s}$, 2 mm below seating plane	T_{sd}	260	$^\circ\text{C}$
Thermal resistance LED junction to ambient		R_{thJA}	100	K/W

OPTICAL AND ELECTRICAL CHARACTERISTICS ($T_{amb} = 25\text{ }^{\circ}\text{C}$, unless otherwise specified)
TDSR1350, TDSR1360, TDSR1360-IK, RED

PARAMETER	TEST CONDITION	PART	SYMBOL	MIN.	TYP.	MAX.	UNIT
Luminous intensity per segment (digit average)	$I_F = 1\text{ mA}$	TDSR1350	I_V	280	-	3600	μcd
		TDSR1360		280	-	3600	
		TDSR1360-IK		1100	-	3600	
Dominant wavelength	$I_F = 1\text{ mA}$	TDSR1350, TDSR1360, TDSR1360-IK	λ_d	-	640	-	nm
Peak wavelength	$I_F = 1\text{ mA}$		λ_p	-	650	-	nm
Angle of half intensity	$I_F = 1\text{ mA}$		ϕ	-	± 50	-	$^{\circ}$
Forward voltage per segment or DP	$I_F = 1\text{ mA}$		V_F	-	1.8	2.4	V
Reverse voltage per segment or DP	$V_R = 6\text{ V}$		I_R	-	10	-	μA

LUMINOUS INTENSITY CLASSIFICATION

GROUP	LIGHT INTENSITY (μcd)	
	MIN.	MAX.
F	280	560
G	450	900
H	700	1400
I	1100	2200
K	1800	3600

Note

- The above type numbers represent the order groups which include only a few brightness groups. Only one group will be shipped in one tube (there will be no mixing of two groups in one tube). In order to ensure availability, single brightness groups will not be orderable.

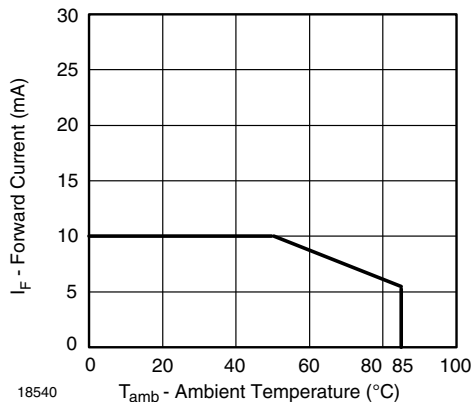
TYPICAL CHARACTERISTICS ($T_{amb} = 25\text{ }^{\circ}\text{C}$, unless otherwise specified)


Fig. 1 - Forward Current vs. Ambient Temperature

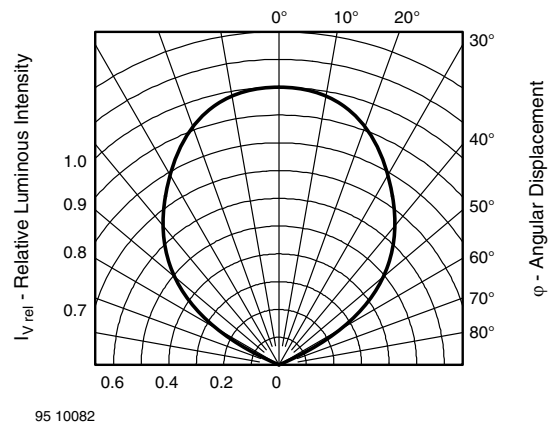


Fig. 2 - Relative Luminous Intensity vs. Angular Displacement

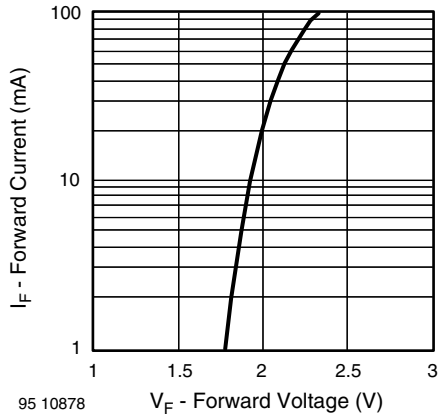


Fig. 3 - Forward Current vs. Forward Voltage

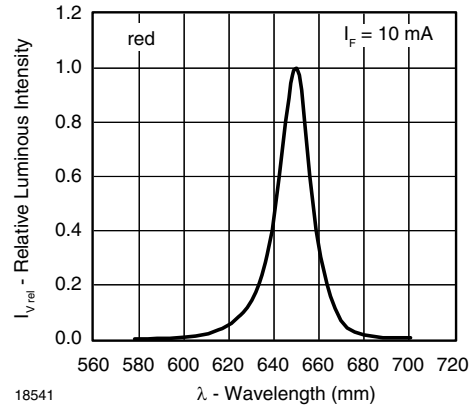


Fig. 6 - Relative Luminous Intensity vs. Ambient Temperature

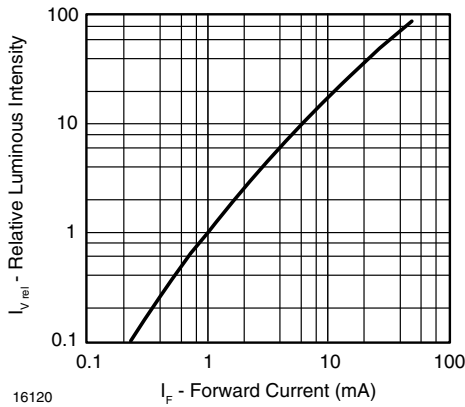


Fig. 4 - Relative Luminous Intensity vs. Forward Current

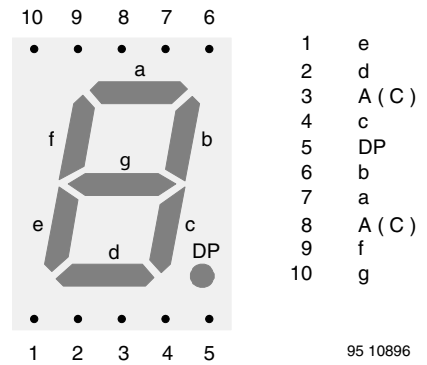


Fig. 7 - TDSR13..

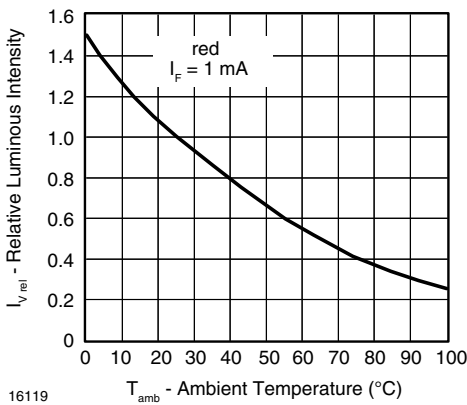
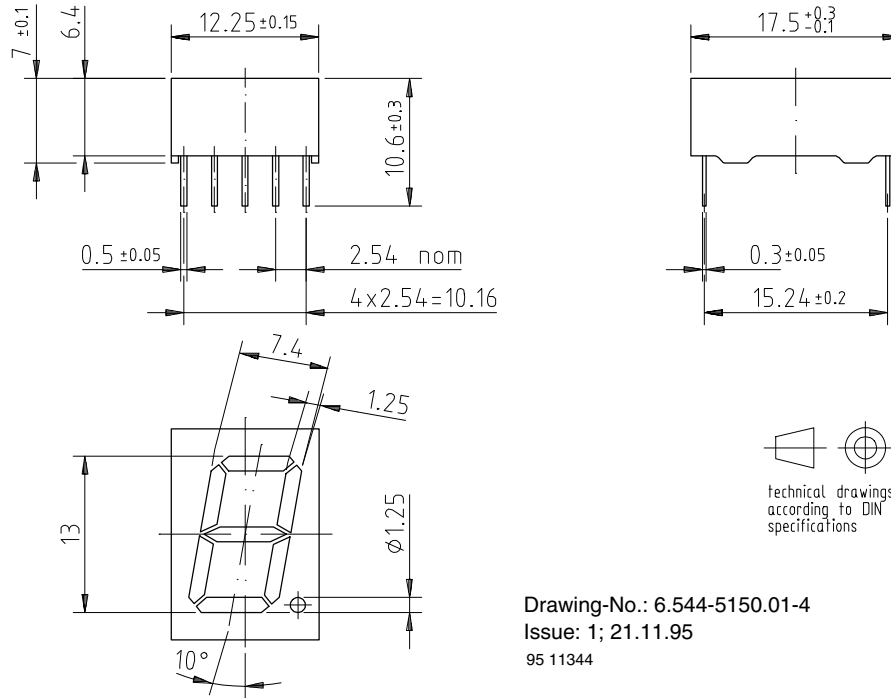


Fig. 5 - Relative Luminous Intensity vs. Ambient Temperature



PACKAGE DIMENSIONS FOR TDSR13.. in millimeters



Drawing-No.: 6.544-5150.01-4

Issue: 1; 21.11.95

95 11344



Disclaimer

ALL PRODUCT, PRODUCT SPECIFICATIONS AND DATA ARE SUBJECT TO CHANGE WITHOUT NOTICE TO IMPROVE RELIABILITY, FUNCTION OR DESIGN OR OTHERWISE.

Vishay Intertechnology, Inc., its affiliates, agents, and employees, and all persons acting on its or their behalf (collectively, "Vishay"), disclaim any and all liability for any errors, inaccuracies or incompleteness contained in any datasheet or in any other disclosure relating to any product.

Vishay makes no warranty, representation or guarantee regarding the suitability of the products for any particular purpose or the continuing production of any product. To the maximum extent permitted by applicable law, Vishay disclaims (i) any and all liability arising out of the application or use of any product, (ii) any and all liability, including without limitation special, consequential or incidental damages, and (iii) any and all implied warranties, including warranties of fitness for particular purpose, non-infringement and merchantability.

Statements regarding the suitability of products for certain types of applications are based on Vishay's knowledge of typical requirements that are often placed on Vishay products in generic applications. Such statements are not binding statements about the suitability of products for a particular application. It is the customer's responsibility to validate that a particular product with the properties described in the product specification is suitable for use in a particular application. Parameters provided in datasheets and / or specifications may vary in different applications and performance may vary over time. All operating parameters, including typical parameters, must be validated for each customer application by the customer's technical experts. Product specifications do not expand or otherwise modify Vishay's terms and conditions of purchase, including but not limited to the warranty expressed therein.

Hyperlinks included in this datasheet may direct users to third-party websites. These links are provided as a convenience and for informational purposes only. Inclusion of these hyperlinks does not constitute an endorsement or an approval by Vishay of any of the products, services or opinions of the corporation, organization or individual associated with the third-party website. Vishay disclaims any and all liability and bears no responsibility for the accuracy, legality or content of the third-party website or for that of subsequent links.

Vishay products are not designed for use in life-saving or life-sustaining applications or any application in which the failure of the Vishay product could result in personal injury or death unless specifically qualified in writing by Vishay. Customers using or selling Vishay products not expressly indicated for use in such applications do so at their own risk. Please contact authorized Vishay personnel to obtain written terms and conditions regarding products designed for such applications.

No license, express or implied, by estoppel or otherwise, to any intellectual property rights is granted by this document or by any conduct of Vishay. Product names and markings noted herein may be trademarks of their respective owners.