

2-Channel EMI-Filter with ESD-Protection



FEATURES

- Ultra compact CLP1007-5M package
- 2-channel EMI-filter and ESD-protection
- Low leakage current
- Line resistance $R_S = 60 \Omega$
- Typical cut off frequency $f_{3dB} = 60 \text{ MHz}$
- ESD-protection acc. IEC 61000-4-2
 $\pm 25 \text{ kV}$ contact discharge
 $\pm 25 \text{ kV}$ air discharge
- e4 - precious metal (e.g. Ag, Au, NiPd, NiPdAu) (no Sn)
- Material categorization: for definitions of compliance please see www.vishay.com/doc?99912



MARKING (example only)

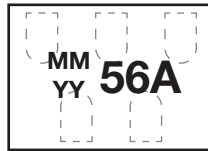

Pin 1

56A = type code
 MM = date code month
 YY = date code year

LINKS TO ADDITIONAL RESOURCES



ORDERING INFORMATION			
DEVICE NAME	ORDERING CODE	TAPED UNITS PER REEL (8 mm TAPE ON 7" REEL)	MINIMUM ORDER QUANTITY
VEMI256A-SD2	VEMI256A-SD2-G4-08	10 000	10 000

PACKAGE DATA						
DEVICE NAME	PACKAGE NAME	TYPE CODE	WEIGHT	MOLDING COMPOUND FLAMMABILITY RATING	MOISTURE SENSITIVITY LEVEL	SOLDERING CONDITIONS
VEMI256A-SD2	CLP1007-5M	56A	0.45 mg	UL 94 V-0	MSL level 1 (according J-STD-020)	Peak temperature max. 260 °C

ABSOLUTE MAXIMUM RATINGS				
PARAMETER	TEST CONDITIONS	SYMBOL	VALUE	UNIT
Peak pulse current	All I/O pin to pin 4; acc. IEC 61000-4-5; $t_p = 8/20 \mu\text{s}$; single shot	I_{PPM}	8.5	A
ESD immunity	Contact discharge acc. IEC 61000-4-2; 10 pulses	V_{ESD}	± 25	kV
	Air discharge acc. IEC 61000-4-2; 10 pulses		± 25	
Operating temperature	Junction temperature	T_J	-40 to +150	°C
Storage temperature		T_{STG}	-55 to +150	°C

APPLICATION NOTE

With the VEMI256A-SD2 two different signal or data lines can be filtered and clamped to ground.

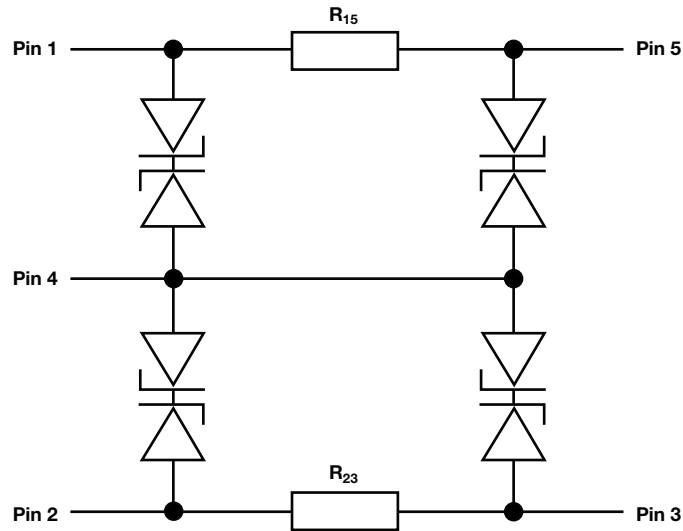

ELECTRICAL CHARACTERISTICS All inputs (pin 1, 2) to ground (pin 4) ($T_{amb} = 25\text{ }^{\circ}\text{C}$, unless otherwise specified)						
PARAMETER	TEST CONDITIONS/REMARKS	SYMBOL	MIN.	TYP.	MAX.	UNIT
Protection paths	Number of channels which can be protected	$N_{channel}$	-	-	2	channel
Reverse stand off voltage	Max. reverse working voltage	V_{RWM}	-	-	5.5	V
Reverse voltage	at $I_R = 0.5\text{ }\mu\text{A}$	V_R	5.5	-	-	V
Reverse current	at $V_R = 5.5\text{ V}$	I_R	-	-	0.5	μA
Reverse break down voltage	$I_R = 1\text{ mA}$	V_{BR}	6	-	-	V
Pos. clamping voltage	at $I_{PP} = 1\text{ A}$ applied at the input, measured at the output; acc. IEC 61000-4-5	V_{C-out}	-	8	10	V
	at $I_{PP} = I_{PPM} = 8.5\text{ A}$ applied at the input, measured at the output; acc. IEC 61000-4-5	V_{C-out}	-	9	11	V
Input capacitance	at $V_R = 0\text{ V}$; $f = 1\text{ MHz}$	C_{IN}	-	116	-	pF
	at $V_R = 2.5\text{ V}$; $f = 1\text{ MHz}$	C_{IN}	-	90	-	pF
ESD-clamping voltage	at $\pm 30\text{ kV}$ ESD-pulse acc. IEC 61000-4-2	V_{CESD}	-	7.5	-	V
Line resistance	Measured between input and output; $I_S = 10\text{ mA}$	R_S	54	60	66	Ω
Cut-off frequency	$V_{IN} = 0\text{ V}$; measured in a $50\text{ }\Omega$ system	f_{3dB}	-	60	-	MHz

TYPICAL CHARACTERISTICS ($T_{amb} = 25\text{ }^{\circ}\text{C}$, unless otherwise specified)

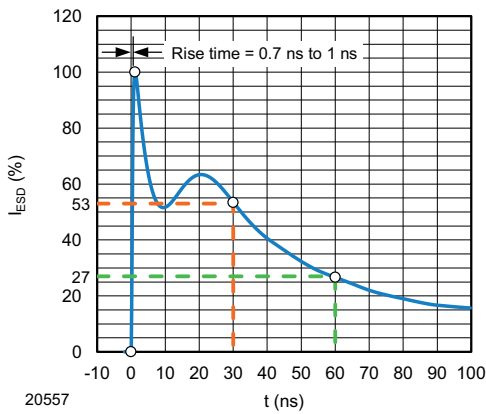

Fig. 1 - ESD Discharge Current Wave Form acc. IEC 61000-4-2 (330 Ω /150 pF)

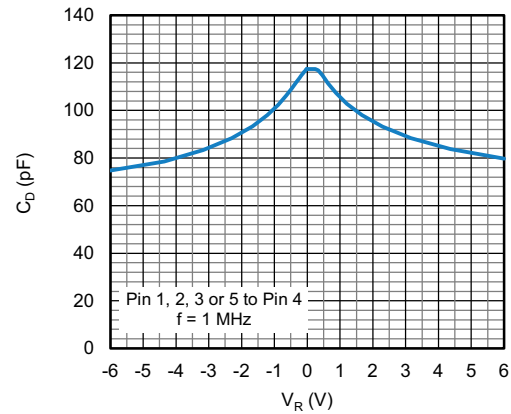

Fig. 4 - Typical Capacitance C_D vs. Reverse Voltage V_R

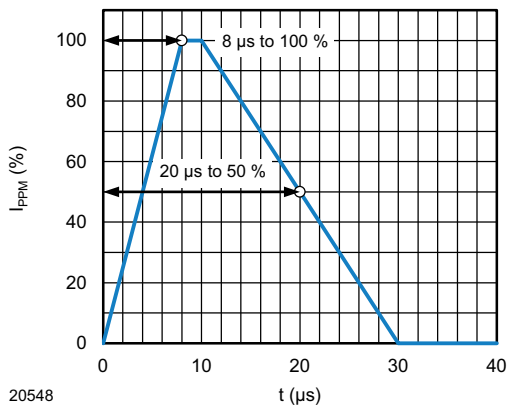

Fig. 2 - 8/20 μs Peak Pulse Current Wave Form acc. IEC 61000-4-5

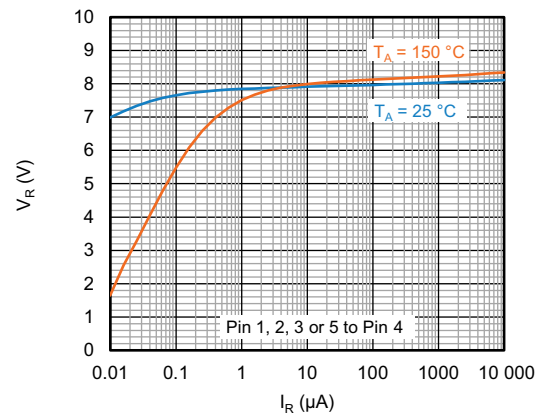

Fig. 5 - Typical Reverse Voltage V_C vs. Reverse Current I_R

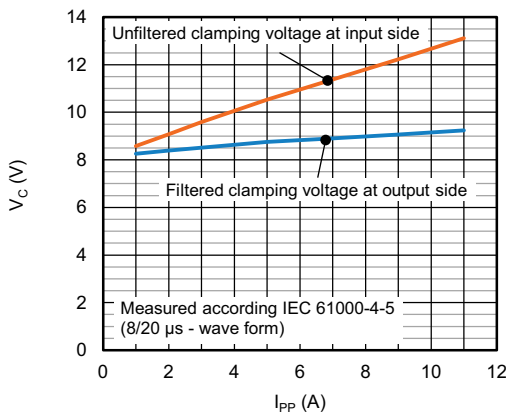

Fig. 3 - Typical Peak Clamping Voltage V_C vs. Peak Pulse Current I_{PP}

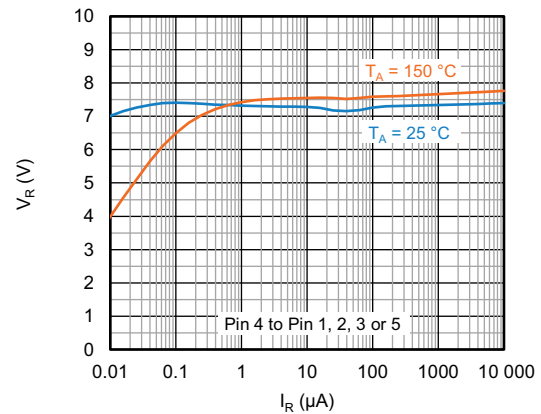

Fig. 6 - Typical Reverse Voltage V_R vs. Reverse Current I_R

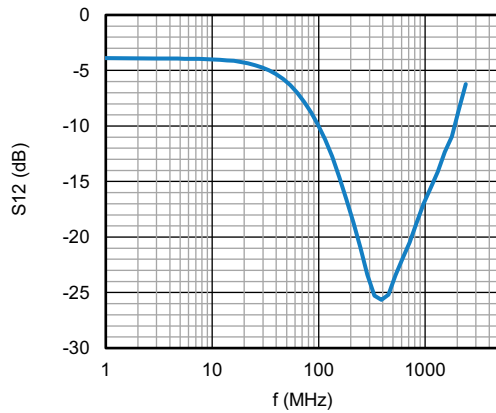
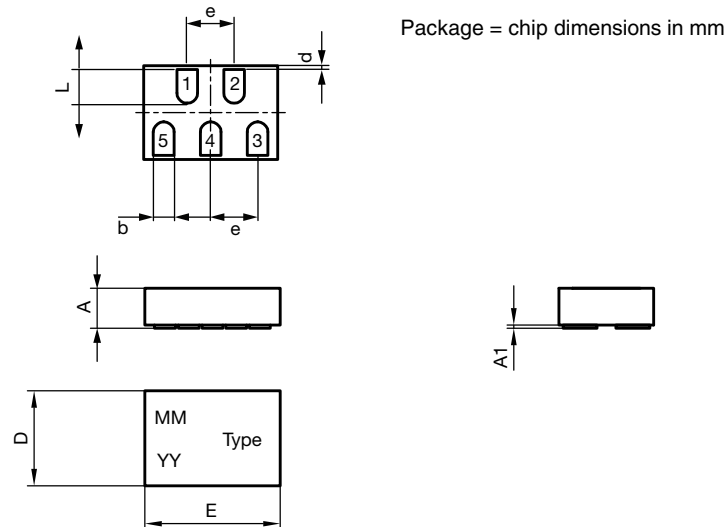

Fig. 7 - Typical Small Signal Transmission (S21)
at $Z_0 = 50 \Omega$

PACKAGE DIMENSIONS in millimeters: **CLP1007-5M**



	Millimeters	
	min.	max.
A	0.25	0.29
A1	-	0.02
b	0.13	0.17
D	0.68	0.73
E	0.98	1.03
e	0.35	
L	0.23	0.27
Radius	0.075	
d	0.03	

foot print recommendation:

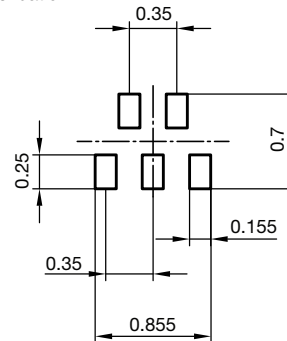

Footprint and soldering recommendation:

please see Application Note: www.vishay.com/doc?85917

CARRIER TAPE in millimeters: **CLP1007-5M**

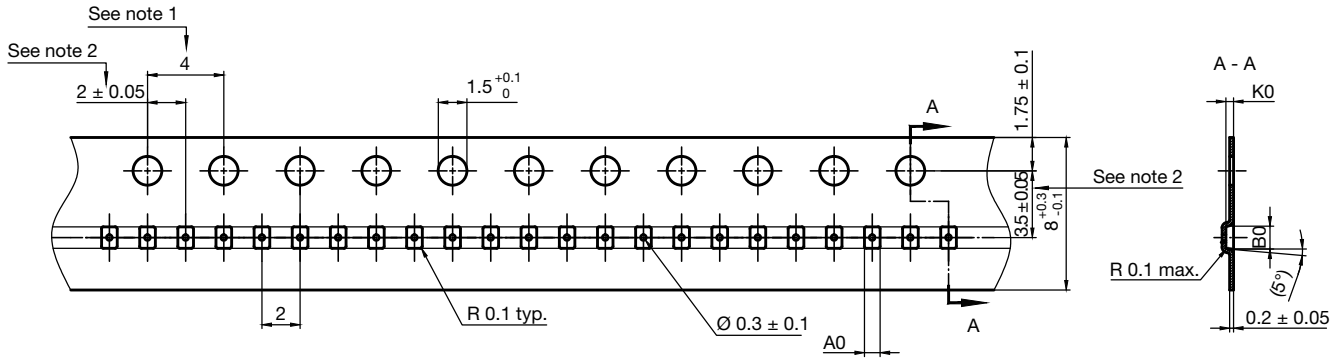

$A0 = 0.82 \pm 0.05$
 $B0 = 1.12 \pm 0.05$
 $K0 = 0.40 \pm 0.05$

Notes:

1. 10 Sprocket hole pitch cumulative tolerance ± 0.2
2. Pocket position relative to sprocket hole measured as true position of pocket, not pocket hole
3. A0 and B0 are calculated on a plane at a distance "R" above the bottom of the pocket

Document no.: S8-V-3906.04-042 (3)
 Created - Date: 23. November 2015
 22858

ORIENTATION IN CARRIER TAPE in millimeters: **CLP1007-5M**

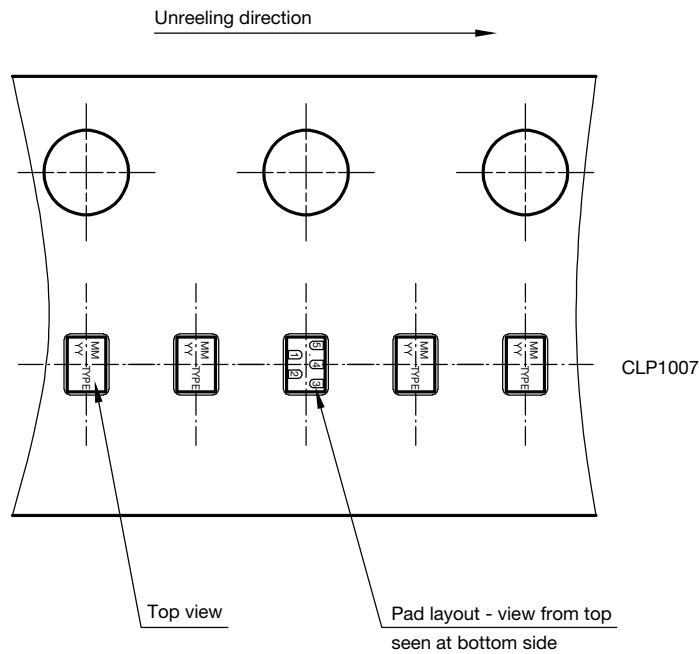



Disclaimer

ALL PRODUCT, PRODUCT SPECIFICATIONS AND DATA ARE SUBJECT TO CHANGE WITHOUT NOTICE TO IMPROVE RELIABILITY, FUNCTION OR DESIGN OR OTHERWISE.

Vishay Intertechnology, Inc., its affiliates, agents, and employees, and all persons acting on its or their behalf (collectively, "Vishay"), disclaim any and all liability for any errors, inaccuracies or incompleteness contained in any datasheet or in any other disclosure relating to any product.

Vishay makes no warranty, representation or guarantee regarding the suitability of the products for any particular purpose or the continuing production of any product. To the maximum extent permitted by applicable law, Vishay disclaims (i) any and all liability arising out of the application or use of any product, (ii) any and all liability, including without limitation special, consequential or incidental damages, and (iii) any and all implied warranties, including warranties of fitness for particular purpose, non-infringement and merchantability.

Statements regarding the suitability of products for certain types of applications are based on Vishay's knowledge of typical requirements that are often placed on Vishay products in generic applications. Such statements are not binding statements about the suitability of products for a particular application. It is the customer's responsibility to validate that a particular product with the properties described in the product specification is suitable for use in a particular application. Parameters provided in datasheets and / or specifications may vary in different applications and performance may vary over time. All operating parameters, including typical parameters, must be validated for each customer application by the customer's technical experts. Product specifications do not expand or otherwise modify Vishay's terms and conditions of purchase, including but not limited to the warranty expressed therein.

Hyperlinks included in this datasheet may direct users to third-party websites. These links are provided as a convenience and for informational purposes only. Inclusion of these hyperlinks does not constitute an endorsement or an approval by Vishay of any of the products, services or opinions of the corporation, organization or individual associated with the third-party website. Vishay disclaims any and all liability and bears no responsibility for the accuracy, legality or content of the third-party website or for that of subsequent links.

Except as expressly indicated in writing, Vishay products are not designed for use in medical, life-saving, or life-sustaining applications or for any other application in which the failure of the Vishay product could result in personal injury or death. Customers using or selling Vishay products not expressly indicated for use in such applications do so at their own risk. Please contact authorized Vishay personnel to obtain written terms and conditions regarding products designed for such applications.

No license, express or implied, by estoppel or otherwise, to any intellectual property rights is granted by this document or by any conduct of Vishay. Product names and markings noted herein may be trademarks of their respective owners.