

Surface-Mount TRANSZORB® Transient Voltage Suppressors

SMA (DO-214AC)

 Cathode  Anode 
LINKS TO ADDITIONAL RESOURCES

PRIMARY CHARACTERISTICS	
V_{BR}	6.4 V to 34.4 V
V_{WM}	5.0 V to 28 V
P_{PPM} (10 x 1000 μ s)	600 W
P_{PPM} (8 x 20 μ s)	4000 W
P_D at $T_A = 50^\circ\text{C}$	4 W
I_{FSM}	50 A
T_J max.	150 $^\circ\text{C}$
Polarity	Unidirectional
Package	SMA (DO-214AC)

FEATURES

- Low profile package
- Ideal for automated placement
- Available in unidirectional polarity only
- Excellent clamping capability
- Meets MSL level 1, per J-STD-020, LF maximum peak of 260 $^\circ\text{C}$
- Material categorization: for definitions of compliance please see www.vishay.com/doc?99912

RoHS
COMPLIANT
HALOGEN
FREE
Available

TYPICAL APPLICATIONS

Use in sensitive electronics protection against voltage transients induced by inductive load switching and lighting on ICs, MOSFET, signal lines of sensor units for consumer, computer, industrial, and telecommunication.

MECHANICAL DATA
Case: SMA (DO-214AC)

Molding compound meets UL 94 V-0 flammability rating

Base P/N-E3 - RoHS-compliant, and industrial grade

Base P/N-M3 - halogen-free, RoHS-compliant, and industrial grade

Terminals: matte tin plated leads, solderable per J-STD-002 and JESD 22-B102

E3, M3 suffix meets JESD 201 class 2 whisker test

Polarity: color band denotes cathode end

MAXIMUM RATINGS ($T_A = 25^\circ\text{C}$ unless otherwise noted)			
PARAMETER	SYMBOL	VALUE	UNIT
Peak pulse power dissipation with a 10/1000 μ s waveform ⁽¹⁾⁽²⁾	P_{PPM}	600	W
Peak pulse power dissipation with a 8/20 μ s waveform		4000	
Peak pulse current with a 10/1000 μ s waveform (1)(2)	I_{PPM}	See next table	A
Peak pulse current with a 8/20 μ s waveform			
Power dissipation on infinite heatsink, $T_A = 50^\circ\text{C}$	P_D	4.0	W
Peak forward surge current 8.3 ms single half sine-wave	I_{FSM}	50	A
Operating junction and storage temperature range	T_J, T_{STG}	-55 to +150	$^\circ\text{C}$

Notes
⁽¹⁾ Non-repetitive current pulse, per fig. 1 and derated above $T_A = 25^\circ\text{C}$ per fig. 2.

⁽²⁾ Mounted on PCB with 5.0 mm x 5.0 mm copper pads to each terminal

INDEX OF SYMBOLS	
SYMBOL	PARAMETER
V_{WM}	Stand-off voltage
V_{BR}	Breakdown voltage
V_C	Clamping voltage
I_D	Leakage current at V_{WM}
I_{PP}	Peak pulse current
αT	Voltage temperature coefficient
V_F	Forward voltage drop
R_D	Dynamic resistance

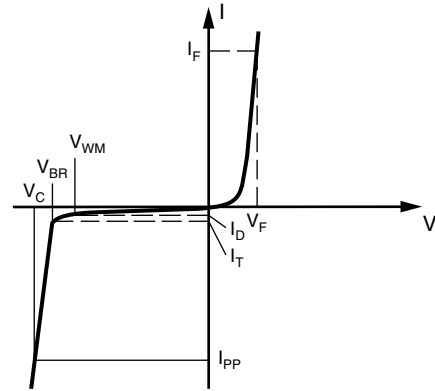

ELECTRICAL CHARACTERISTICS ($T_A = 25\text{ }^\circ\text{C}$ unless otherwise noted)														
DEVICE TYPE	DEVICE MARKING CODE	BREAKDOWN VOLTAGE V_{BR} AT I_T (1)			MAXIMUM REVERSE LEAKAGE I_D AT V_{WM}		STAND-OFF VOLTAGE V_{WM}	V_C AT I_{PP}		R_D (2)	V_C AT I_{PP}		R_D (2)	αT (3)
		MIN.	MAX.		25 °C	85 °C		10/1000 μs			8/20 μs			
		V	mA		μA		V	V	A	Ω	V	A	Ω	MAX.
SMA6J5.0A	6AE	6.4	7.07	10	150	375	5.0	9.1	65.9	0.031	13.4	298	0.021	5.7
SMA6J6.0A	6AG	6.7	7.41	10	600	1500	6.0	9.5	63.2	0.033	13.7	290	0.022	5.9
SMA6J6.5A	6AK	7.2	7.96	10	100	250	6.5	10.2	58.8	0.038	14.5	276	0.024	6.1
SMA6J7.5A	6AP	8.33	9.21	1	50	125	7.5	11.8	50.8	0.051	17.0	235	0.033	6.5
SMA6J8.0A	6AR	8.89	9.83	1	20	50	8.0	12.5	48.0	0.056	18.2	220	0.038	7.0
SMA6J8.5A	6AT	9.4	10.4	1	20	50	8.5	13.3	45.1	0.064	18.7	205	0.040	7.3
SMA6J10A	6AX	11.1	12.3	1	1	5	10	15.7	38.2	0.089	19.6	184	0.040	7.8
SMA6J11A	6AZ	12.2	13.5	1	1	5	11	17.2	34.8	0.107	21.5	172	0.047	8.1
SMA6J12A	6BE	13.3	14.7	1	0.2	1	12	18.8	31.9	0.128	23.5	157	0.056	8.3
SMA6J13A	6BG	14.4	15.9	1	0.2	1	13	20.4	29.4	0.153	23.9	147	0.054	8.4
SMA6J15A	6BM	16.7	18.5	1	0.2	1	15	23.6	25.4	0.201	27.7	123	0.075	8.8
SMA6J16A	6BP	17.8	19.7	1	0.2	1	16	25.2	23.8	0.229	29.5	119	0.083	8.8
SMA6J17A	6BR	18.9	20.9	1	0.2	1	17	26.7	22.5	0.259	31.4	111	0.094	9.0
SMA6J18A	6BT	20.0	22.1	1	0.2	1	18	28.3	21.2	0.292	33.2	102	0.109	9.2
SMA6J20A	6BV	22.2	24.5	1	0.2	1	20	31.4	19.1	0.361	36.8	93	0.132	9.4
SMA6J22A	6BX	24.4	26.9	1	0.2	1	22	34.5	17.4	0.437	40.4	89	0.152	9.5
SMA6J24A	6BZ	26.7	29.5	1	0.2	1	24	37.8	15.9	0.523	44.3	80	0.185	9.6
SMA6J26A	6CE	28.9	31.9	1	0.2	1	26	40.9	14.7	0.614	47.9	75	0.213	9.7
SMA6J28A	6CG	31.1	34.4	1	0.2	1	28	44.0	13.6	0.704	51.6	68	0.253	9.8

Notes

- (1) Pulse test: $t_p \leq 50\text{ ms}$
- (2) To calculate maximum clamping voltage at other surge currents, use the following formula: $V_{CLmax.} = R_D \times I_{PP} + V_{BRmax.}$
- (3) To calculate V_{BR} vs. junction temperature, use the following formula: V_{BR} at $T_J = V_{BR}$ at $25\text{ }^\circ\text{C} \times (1 + \alpha T \times (T_J - 25))$
- (4) $V_F = 3.5\text{ V}$ at $I_F = 25\text{ A}$, pulse test: 300 μs pulse width



THERMAL CHARACTERISTICS ($T_A = 25\text{ }^\circ\text{C}$ unless otherwise noted)			
PARAMETER	SYMBOL	VALUE	UNIT
Typical thermal resistance, junction to ambient ⁽¹⁾	$R_{\theta JA}$	120	$^\circ\text{C/W}$
Typical thermal resistance, junction to lead	$R_{\theta JL}$	25	

Note

⁽¹⁾ Mounted on minimum recommended pad layout

ORDERING INFORMATION (Example)				
PREFERRED P/N	UNIT WEIGHT (g)	PREFERRED PACKAGE CODE	BASE QUANTITY	DELIVERY MODE
SMA6J5.0A-E3/61	0.064	61	1800	7" diameter plastic tape and reel
SMA6J5.0A-M3/61	0.064	61	1800	7" diameter plastic tape and reel
SMA6J5.0A-E3/5A	0.064	5A	7500	13" diameter plastic tape and reel
SMA6J5.0A-M3/5A	0.064	5A	7500	13" diameter plastic tape and reel

RATINGS AND CHARACTERISTICS CURVES ($T_A = 25\text{ }^\circ\text{C}$ unless otherwise noted)

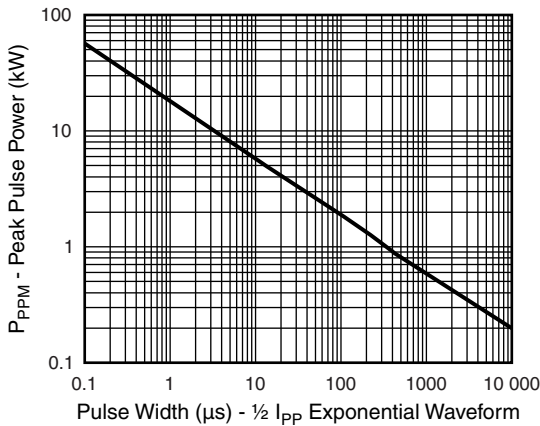

Fig. 1 - Peak Pulse Power Rating Curve

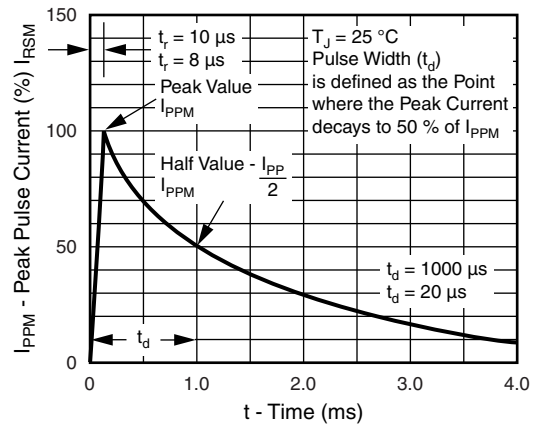

Fig. 3 - Pulse Waveform

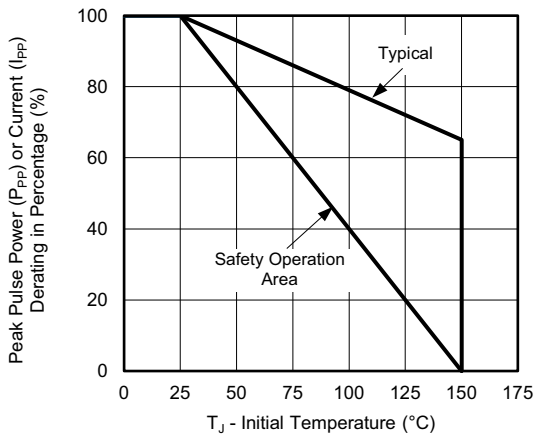

Fig. 2 - Pulse Power or Current vs. Initial Junction Temperature

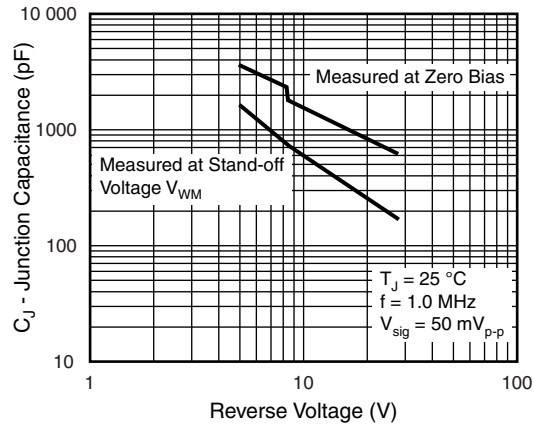

Fig. 4 - Typical Junction Capacitance

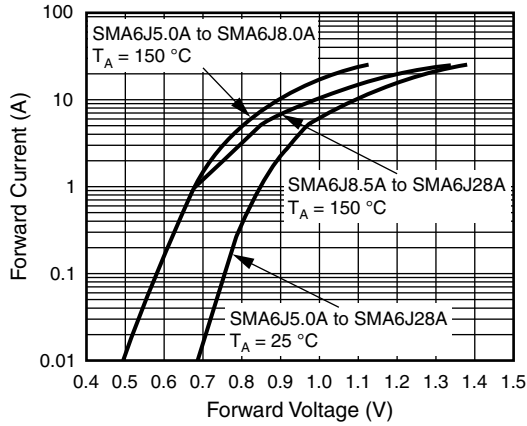

Fig. 5 - Typical Forward Characteristics

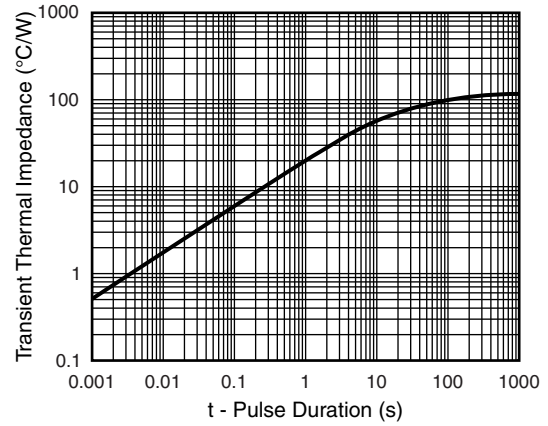
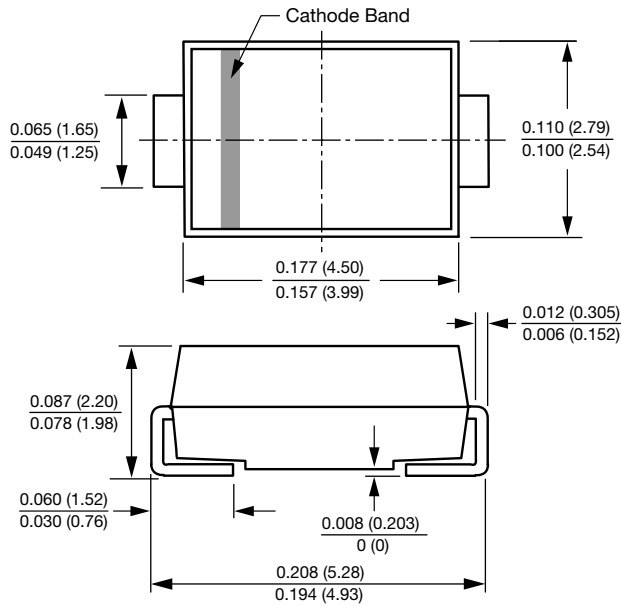

Fig. 6 - Typical Transient Thermal Impedance

PACKAGE OUTLINE DIMENSIONS in inches (millimeters)

SMA (DO-214AC)



Mounting Pad Layout

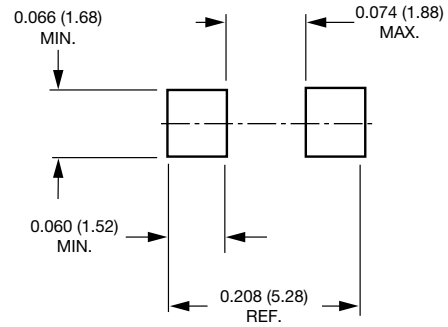



Disclaimer

ALL PRODUCT, PRODUCT SPECIFICATIONS AND DATA ARE SUBJECT TO CHANGE WITHOUT NOTICE TO IMPROVE RELIABILITY, FUNCTION OR DESIGN OR OTHERWISE.

Vishay Intertechnology, Inc., its affiliates, agents, and employees, and all persons acting on its or their behalf (collectively, "Vishay"), disclaim any and all liability for any errors, inaccuracies or incompleteness contained in any datasheet or in any other disclosure relating to any product.

Vishay makes no warranty, representation or guarantee regarding the suitability of the products for any particular purpose or the continuing production of any product. To the maximum extent permitted by applicable law, Vishay disclaims (i) any and all liability arising out of the application or use of any product, (ii) any and all liability, including without limitation special, consequential or incidental damages, and (iii) any and all implied warranties, including warranties of fitness for particular purpose, non-infringement and merchantability.

Statements regarding the suitability of products for certain types of applications are based on Vishay's knowledge of typical requirements that are often placed on Vishay products in generic applications. Such statements are not binding statements about the suitability of products for a particular application. It is the customer's responsibility to validate that a particular product with the properties described in the product specification is suitable for use in a particular application. Parameters provided in datasheets and / or specifications may vary in different applications and performance may vary over time. All operating parameters, including typical parameters, must be validated for each customer application by the customer's technical experts. Product specifications do not expand or otherwise modify Vishay's terms and conditions of purchase, including but not limited to the warranty expressed therein.

Hyperlinks included in this datasheet may direct users to third-party websites. These links are provided as a convenience and for informational purposes only. Inclusion of these hyperlinks does not constitute an endorsement or an approval by Vishay of any of the products, services or opinions of the corporation, organization or individual associated with the third-party website. Vishay disclaims any and all liability and bears no responsibility for the accuracy, legality or content of the third-party website or for that of subsequent links.

Vishay products are not designed for use in life-saving or life-sustaining applications or any application in which the failure of the Vishay product could result in personal injury or death unless specifically qualified in writing by Vishay. Customers using or selling Vishay products not expressly indicated for use in such applications do so at their own risk. Please contact authorized Vishay personnel to obtain written terms and conditions regarding products designed for such applications.

No license, express or implied, by estoppel or otherwise, to any intellectual property rights is granted by this document or by any conduct of Vishay. Product names and markings noted herein may be trademarks of their respective owners.