

FRED Pt[®], Ultrafast Soft Recovery Diode Module, 400 A

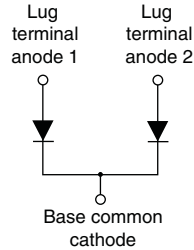

TO-244

FEATURES

- Ultrafast recovery
- UL approved file E222165
- Designed for industrial level
- Material categorization: for definitions of compliance please see www.vishay.com/doc?99912

**RoHS
COMPLIANT**
BENEFITS

- Reduced RFI and EMI
- Higher frequency operation
- Reduced snubbing
- Reduced parts count

DESCRIPTION / APPLICATIONS

FRED Pt[®] diodes are optimized to reduce losses and EMI/RFI in high frequency power conditioning systems. The softness of the recovery eliminates the need for a snubber in most applications. These devices are ideally suited for HF welding, power converters and other applications where switching losses are significant portion of the total losses.

PRIMARY CHARACTERISTICS	
$I_{F(AV)}$	400 A
V_R	600 V
Q_{rr}	830 nC
t_{rr}	90 ns
Type	Modules - diode, FRED Pt [®]
Package	TO-244
Circuit configuration	Two diodes common cathode

ABSOLUTE MAXIMUM RATINGS				
PARAMETER	SYMBOL	TEST CONDITIONS	MAX.	UNITS
Cathode to anode voltage	V_R		600	V
Continuous forward current per diode	$I_{F(AV)}$	$T_C = 25\text{ }^\circ\text{C}$	330	A
		$T_C = 85\text{ }^\circ\text{C}$	230	
		$T_C = 97\text{ }^\circ\text{C}$	200	
Single pulse forward current per diode	I_{FSM}	$T_C = 25\text{ }^\circ\text{C}$	2520	
Maximum power dissipation	P_D	$T_C = 25\text{ }^\circ\text{C}$	660	W
		$T_C = 97\text{ }^\circ\text{C}$	280	
Operating junction and storage temperatures	T_J, T_{Stg}		-40 to +150	$^\circ\text{C}$

ELECTRICAL SPECIFICATIONS PER LEG ($T_J = 25\text{ }^\circ\text{C}$ unless otherwise specified)						
PARAMETER	SYMBOL	TEST CONDITIONS	MIN.	TYP.	MAX.	UNITS
Breakdown voltage	V_{BR}	$I_R = 100\text{ }\mu\text{A}$	600	-	-	V
Forward voltage	V_{FM}	$I_F = 200\text{ A}$	-	1.45	2.0	
		$I_F = 400\text{ A}$	-	1.67	2.3	
		$I_F = 200\text{ A}, T_J = 150\text{ }^\circ\text{C}$	-	1.13	1.4	
		$I_F = 400\text{ A}, T_J = 150\text{ }^\circ\text{C}$	-	1.39	1.8	
Reverse leakage current	I_{RM}	$T_J = 150\text{ }^\circ\text{C}, V_R = V_R\text{ rated}$	-	0.3	1.38	mA
Series inductance	L_S	From top of terminal hole to mounting plane	-	5	-	nH



DYNAMIC RECOVERY CHARACTERISTICS ($T_J = 25\text{ }^\circ\text{C}$ unless otherwise specified)							
PARAMETER	SYMBOL	TEST CONDITIONS		MIN.	TYP.	MAX.	UNITS
Reverse recovery time	t_{rr}	$T_J = 25\text{ }^\circ\text{C}$	$I_F = 200\text{ A}$, $di_F/dt = 200\text{ A}/\mu\text{s}$, $V_R = 200\text{ V}$	-	90	-	ns
		$T_J = 150\text{ }^\circ\text{C}$		-	240	-	
Peak recovery current	I_{RRM}	$I_F = 200\text{ A}$, $di_F/dt = 200\text{ A}/\mu\text{s}$, $V_R = 200\text{ V}$		-	8.3	-	A
		$I_F = 200\text{ A}$, $di_F/dt = 200\text{ A}/\mu\text{s}$, $V_R = 200\text{ V}$, $T_J = 150\text{ }^\circ\text{C}$		-	24	-	
Reverse recovery charge	Q_{rr}	$I_F = 200\text{ A}$, $di_F/dt = 200\text{ A}/\mu\text{s}$, $V_R = 200\text{ V}$		-	830	-	nC
		$I_F = 200\text{ A}$, $di_F/dt = 200\text{ A}/\mu\text{s}$, $V_R = 200\text{ V}$, $T_J = 150\text{ }^\circ\text{C}$		-	4730	-	

THERMAL - MECHANICAL SPECIFICATIONS						
PARAMETER		SYMBOL	MIN.	TYP.	MAX.	UNITS
Thermal resistance, junction to case	per leg	R_{thJC}	-	-	0.19	$^\circ\text{C}/\text{W}$
	per module		-	-	0.095	
Thermal resistance, case to heatsink		R_{thCS}	-	0.10	-	
Weight			-	68	-	g
			-	2.4	-	oz.
Mounting torque			30 (3.4)	-	40 (4.6)	lbf · in (N · m)
Mounting torque center hole			12 (1.4)	-	18 (2.1)	
Terminal torque			30 (3.4)	-	40 (4.6)	
Vertical pull			-	-	80	lbf · in
2" lever pull			-	-	35	
Case style			TO-244			

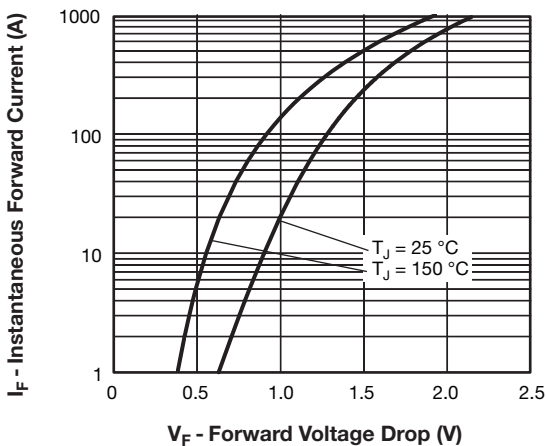

Fig. 1 - Typical Forward Voltage Drop vs. Instantaneous Forward Current (Per Leg)

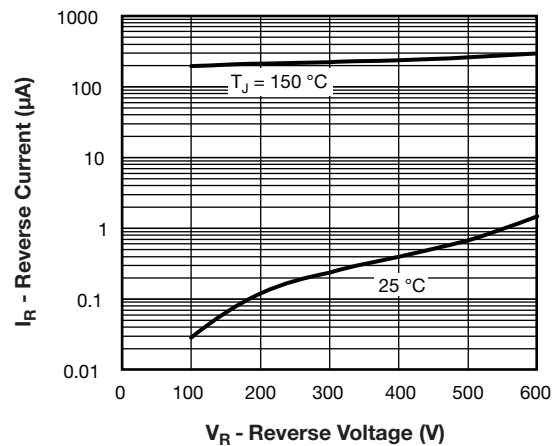

Fig. 2 - Typical Reverse Current vs. Reverse Voltage (Per Leg)

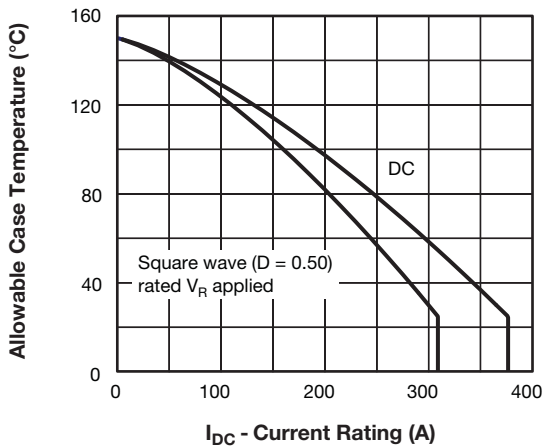

Fig. 3 - Maximum Current Rating Capability (Per Leg)

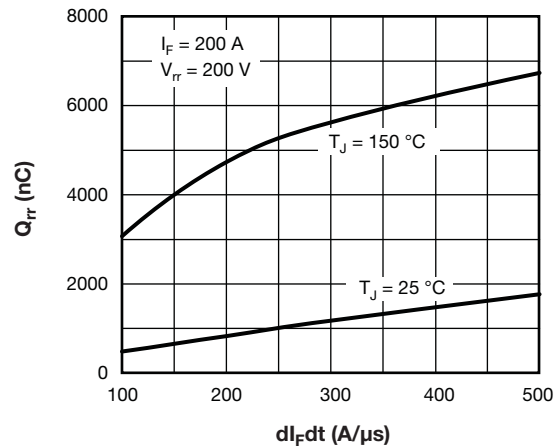

Fig. 6 - Typical Reverse Recovery Charge vs. di_F/dt (Per Leg)

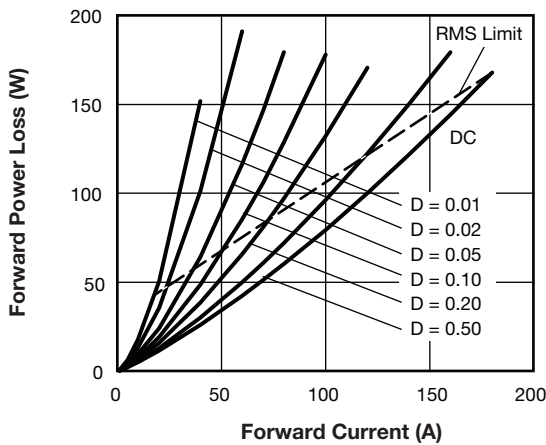

Fig. 4 - Forward Power Loss Characteristics

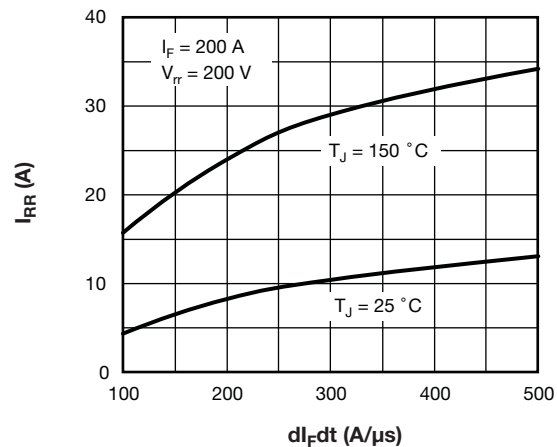

Fig. 7 - Typical Reverse Recovery Current vs. di_F/dt (Per Leg)

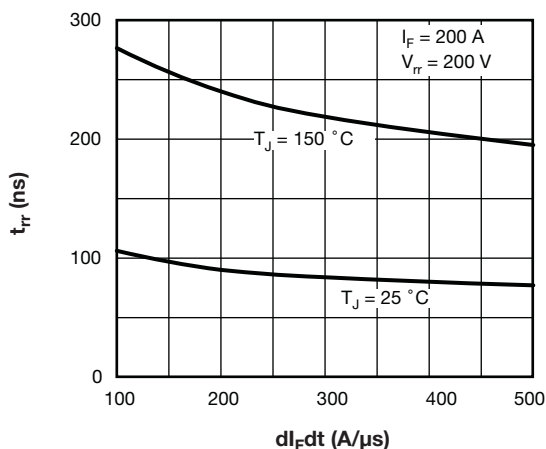

Fig. 5 - Typical Reverse Recovery Time vs. di_F/dt (Per Leg)

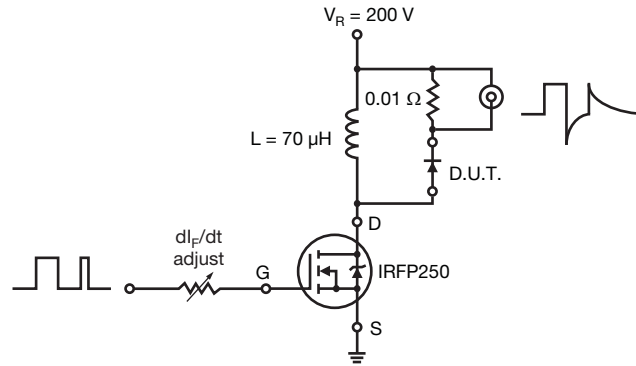

Fig. 8 - Reverse Recovery Parameter Test Circuit

ORDERING INFORMATION TABLE

Device code	VS-VS	UD	400	C	W	60
	①	②	③	④	⑤	⑥

- 1** - Vishay Semiconductors product
- 2** - UD = FRED Pt[®]
- 3** - Current rating (400 = 400 A)
- 4** - Circuit configuration:
C = two diodes common cathode
- 5** - W = TO-244 wire bondable not insulated
- 6** - Voltage rating (60 = 600 V)

CIRCUIT CONFIGURATION		
CIRCUIT	CIRCUIT CONFIGURATION CODE	CIRCUIT DRAWING
Two diodes common cathode	C	

LINKS TO RELATED DOCUMENTS	
Dimensions	www.vishay.com/doc?95021



TO-244

DIMENSIONS in millimeters (inches)





Disclaimer

ALL PRODUCT, PRODUCT SPECIFICATIONS AND DATA ARE SUBJECT TO CHANGE WITHOUT NOTICE TO IMPROVE RELIABILITY, FUNCTION OR DESIGN OR OTHERWISE.

Vishay Intertechnology, Inc., its affiliates, agents, and employees, and all persons acting on its or their behalf (collectively, "Vishay"), disclaim any and all liability for any errors, inaccuracies or incompleteness contained in any datasheet or in any other disclosure relating to any product.

Vishay makes no warranty, representation or guarantee regarding the suitability of the products for any particular purpose or the continuing production of any product. To the maximum extent permitted by applicable law, Vishay disclaims (i) any and all liability arising out of the application or use of any product, (ii) any and all liability, including without limitation special, consequential or incidental damages, and (iii) any and all implied warranties, including warranties of fitness for particular purpose, non-infringement and merchantability.

Statements regarding the suitability of products for certain types of applications are based on Vishay's knowledge of typical requirements that are often placed on Vishay products in generic applications. Such statements are not binding statements about the suitability of products for a particular application. It is the customer's responsibility to validate that a particular product with the properties described in the product specification is suitable for use in a particular application. Parameters provided in datasheets and / or specifications may vary in different applications and performance may vary over time. All operating parameters, including typical parameters, must be validated for each customer application by the customer's technical experts. Product specifications do not expand or otherwise modify Vishay's terms and conditions of purchase, including but not limited to the warranty expressed therein.

Hyperlinks included in this datasheet may direct users to third-party websites. These links are provided as a convenience and for informational purposes only. Inclusion of these hyperlinks does not constitute an endorsement or an approval by Vishay of any of the products, services or opinions of the corporation, organization or individual associated with the third-party website. Vishay disclaims any and all liability and bears no responsibility for the accuracy, legality or content of the third-party website or for that of subsequent links.

Vishay products are not designed for use in life-saving or life-sustaining applications or any application in which the failure of the Vishay product could result in personal injury or death unless specifically qualified in writing by Vishay. Customers using or selling Vishay products not expressly indicated for use in such applications do so at their own risk. Please contact authorized Vishay personnel to obtain written terms and conditions regarding products designed for such applications.

No license, express or implied, by estoppel or otherwise, to any intellectual property rights is granted by this document or by any conduct of Vishay. Product names and markings noted herein may be trademarks of their respective owners.