



**Three Phase Controlled Bridge (Power Modules),
55 A to 110 A**



MTK

FEATURES

- Package fully compatible with the industry standard INT-A-PAK power modules series
- High thermal conductivity package, electrically insulated case
- Excellent power volume ratio
- 4000 V_{RMS} isolating voltage
- UL E78996 approved 
- Designed and qualified for industrial level
- Material categorization: for definitions of compliance please see www.vishay.com/doc?99912



PRIMARY CHARACTERISTICS	
I_o	55 A to 110 A
V_{RRM}	800 V to 1600 V
Package	MTK
Circuit configuration	Three phase bridge

DESCRIPTION

A range of extremely compact, encapsulated three phase controlled bridge rectifiers offering efficient and reliable operation. They are intended for use in general purpose and heavy duty applications.

MAJOR RATINGS AND CHARACTERISTICS					
SYMBOL	CHARACTERISTICS	VALUES 5.MT...K	VALUES 9.MT...K	VALUES 11.MT...K	UNITS
I_o		55	90	110	A
	T_C	85	85	85	°C
I_{FSM}	50 Hz	390	950	1130	A
	60 Hz	410	1000	1180	
I^2t	50 Hz	770	4525	6380	A ² s
	60 Hz	700	4130	5830	
$I^2\sqrt{t}$		7700	45 250	63 800	A ² √s
V_{RRM}	Range	800 to 1600			V
T_{Stg}	Range	-40 to +125			°C
T_J	Range	-40 to +125			°C

ELECTRICAL SPECIFICATIONS

VOLTAGE RATINGS					
TYPE NUMBER	VOLTAGE CODE	V_{RRM} , MAXIMUM REPETITIVE PEAK REVERSE VOLTAGE V	V_{RSM} , MAXIMUM NON-REPETITIVE PEAK REVERSE VOLTAGE V	V_{DRM} , MAXIMUM REPETITIVE PEAK OFF-STATE VOLTAGE, GATE OPEN CIRCUIT V	I_{RRM}/I_{DRM} , MAXIMUM AT $T_J = 125^\circ\text{C}$ mA
VS-5.MT...K	80	800	900	800	10
	100	1000	1100	1000	
	120	1200	1300	1200	
	140	1400	1500	1400	
	160	1600	1700	1600	
VS-9.MT...K VS-11.MT...K	80	800	900	800	20
	100	1000	1100	1000	
	120	1200	1300	1200	
	140	1400	1500	1400	
	160	1600	1700	1600	



FORWARD CONDUCTION							
PARAMETER	SYMBOL	TEST CONDITIONS		VALUES 5.MT...K	VALUES 9.MT...K	VALUES 11.MT...K	UNITS
Maximum DC output current at case temperature	I _O	120° rect. conduction angle		55	90	110	A
				85	85	85	°C
Maximum peak, one-cycle forward, non-repetitive on state surge current	I _{TSM}	t = 10 ms	No voltage reapplied	390	950	1130	A
		t = 8.3 ms		410	1000	1180	
		t = 10 ms	100 % V _{RRM} reapplied	330	800	950	
		t = 8.3 ms		345	840	1000	
Maximum I ² t for fusing	I ² t	t = 10 ms	No voltage reapplied	770	4525	6380	A ² s
		t = 8.3 ms		700	4130	5830	
		t = 10 ms	100 % V _{RRM} reapplied	540	3200	4510	
		t = 8.3 ms		500	2920	4120	
Maximum I ² √t for fusing	I ² √t	t = 0.1 ms to 10 ms, no voltage reapplied		7700	45 250	63 800	A ² √s
Low level value of threshold voltage	V _{T(TO)1}	(16.7 % × π × I _{T(AV)} < I < π × I _{T(AV)}), T _J maximum		1.17	1.09	1.04	V
High level value of threshold voltage	V _{T(TO)2}	(I > π × I _{T(AV)}), T _J maximum		1.45	1.27	1.27	
Low level value on-state slope resistance	r _{t1}	(16.7 % × π × I _{T(AV)} < I < π × I _{T(AV)}), T _J maximum		12.40	4.10	3.93	mΩ
High level value on-state slope resistance	r _{t2}	(I > π × I _{T(AV)}), T _J maximum		11.04	3.59	3.37	
Maximum on-state voltage drop	V _{TM}	I _{pk} = 150 A, T _J = 25 °C, t _p = 400 μs single junction		2.68	1.65	1.57	V
Maximum non-repetitive rate of rise of turned on current	di/dt	T _J = 25 °C, from 0.67 V _{DRM} , I _{TM} = π × I _{T(AV)} , I _g = 500 mA, t _r < 0.5 μs, t _p > 6 μs		150			A/μs
Maximum holding current	I _H	T _J = 25 °C, anode supply = 6 V, resistive load, gate open circuit		200			mA
Maximum latching current	I _L	T _J = 25 °C, anode supply = 6 V, resistive load		400			

BLOCKING							
PARAMETER	SYMBOL	TEST CONDITIONS		VALUES 5.MT...K	VALUES 9.MT...K	VALUES 11.MT...K	UNITS
RMS isolation voltage	V _{ISOL}	T _J = 25 °C all terminal shorted, f = 50 Hz, t = 1 s		4000			V
Maximum critical rate of rise of off-state voltage	dV/dt ⁽¹⁾	T _J = T _J maximum, linear to 0.67 V _{DRM} , gate open circuit		500			V/μs

Note

⁽¹⁾ Available with dV/dt = 1000 V/μs, to complete code add S90 i. e. 113MT160KBS90

TRIGGERING							
PARAMETER	SYMBOL	TEST CONDITIONS		VALUES 5.MT...K	VALUES 9.MT...K	VALUES 11.MT...K	UNITS
Maximum peak gate power	P _{GM}	T _J = T _J maximum		10			W
Maximum average gate power	P _{G(AV)}			2.5			
Maximum peak gate current	I _{GM}			2.5			A
Maximum peak negative gate voltage	-V _{GT}			10			V
Maximum required DC gate voltage to trigger	V _{GT}	T _J = -40 °C	Anode supply = 6 V, resistive load		4.0		
		T _J = 25 °C			2.5		
		T _J = 125 °C			1.7		
Maximum required DC gate current to trigger	I _{GT}	T _J = -40 °C	Anode supply = 6 V, resistive load		270	mA	
		T _J = 25 °C			150		
		T _J = 125 °C			80		
Maximum gate voltage that will not trigger	V _{GD}	T _J = T _J maximum, rated V _{DRM} applied		0.25		V	
Maximum gate current that will not trigger	I _{GD}	T _J = T _J maximum, rated V _{DRM} applied		6		mA	



THERMAL AND MECHANICAL SPECIFICATIONS						
PARAMETER	SYMBOL	TEST CONDITIONS	VALUES 5.MT...K	VALUES 9.MT...K	VALUES 11.MT...K	UNITS
Maximum junction operating and storage temperature range	T_J, T_{Stg}		-40 to +125			°C
Maximum thermal resistance, junction to case	R_{thJC}	DC operation per module	0.18	0.14	0.12	K/W
		DC operation per junction	1.07	0.86	0.70	
		120 °C rect. conduction angle per module	0.19	0.15	0.12	
		120 °C rect. conduction angle per junction	1.17	0.91	0.74	
Maximum thermal resistance, case to heatsink per module	R_{thCS}	Mounting surface smooth, flat and grased	0.03			
Mounting torque $\pm 10\%$	to heatsink to terminal	A mounting compound is recommended and the torque should be rechecked after a period of 3 hours to allow for the spread of the compound. Lubricated threads.	4 to 6			Nm
			3 to 4			
Approximate weight				225		

ΔR CONDUCTION PER JUNCTION											
DEVICES	SINUSOIDAL CONDUCTION AT T_J MAXIMUM					RECTANGULAR CONDUCTION AT T_J MAXIMUM					UNITS
	180°	120°	90°	60°	30°	180°	120°	90°	60°	30°	
5.MT...K	0.072	0.085	0.108	0.152	0.233	0.055	0.091	0.117	0.157	0.236	K/W
9.MT...K	0.033	0.039	0.051	0.069	0.099	0.027	0.044	0.055	0.071	0.100	
11.MT...K	0.027	0.033	0.042	0.057	0.081	0.023	0.037	0.046	0.059	0.082	

Note

- Table shows the increment of thermal resistance R_{thJC} when devices operate at different conduction angles than DC

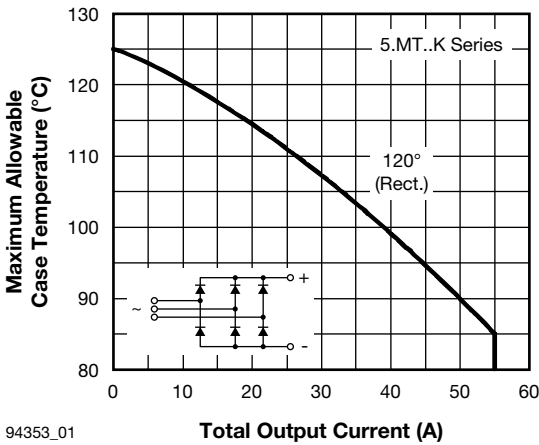

Fig. 1 - Current Ratings Characteristic

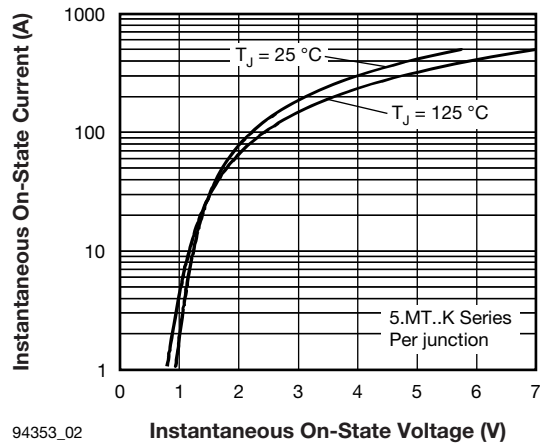
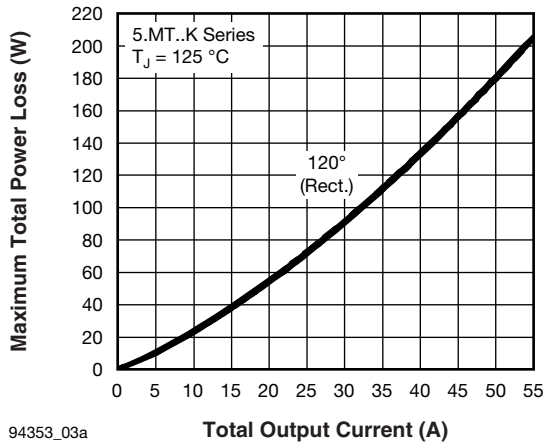
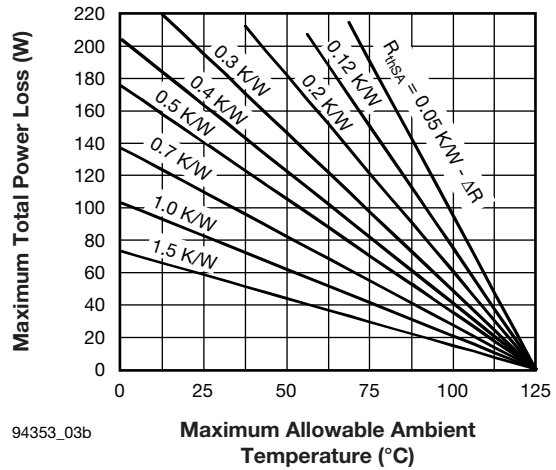

Fig. 2 - Forward Voltage Drop Characteristics



94353_03a



94353_03b

Fig. 3 - Total Power Loss Characteristics

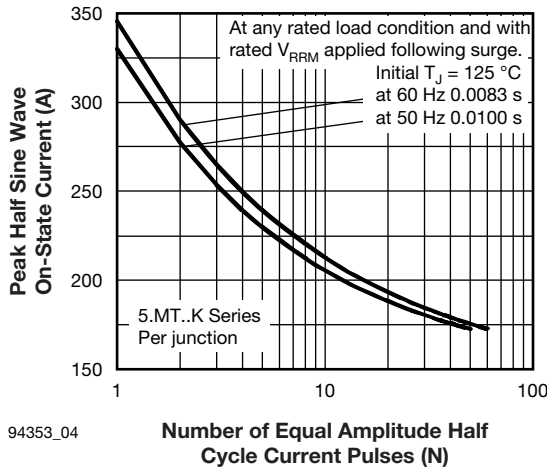

94353_04

Fig. 4 - Maximum Non-Repetitive Surge Current

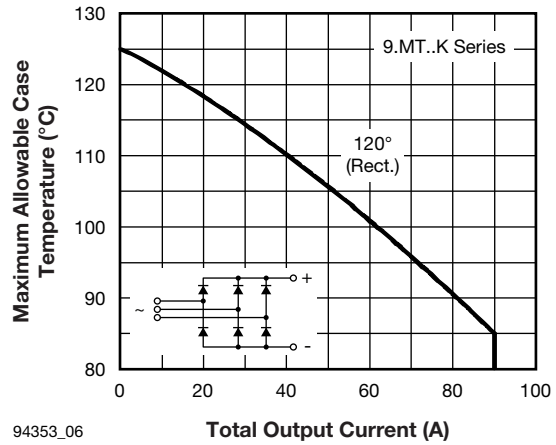

94353_06

Fig. 6 - Current Ratings Characteristic

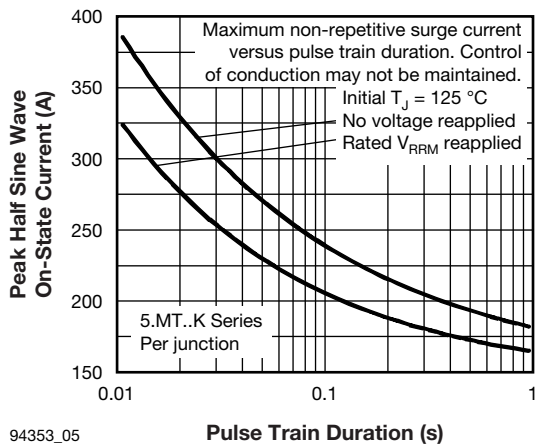

94353_05

Fig. 5 - Maximum Non-Repetitive Surge Current

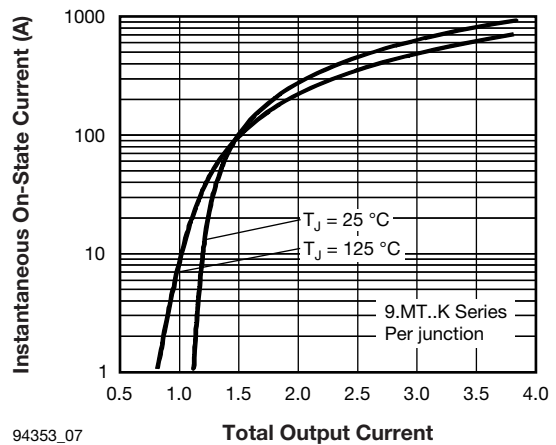

94353_07

Fig. 7 - Forward Voltage Drop Characteristics

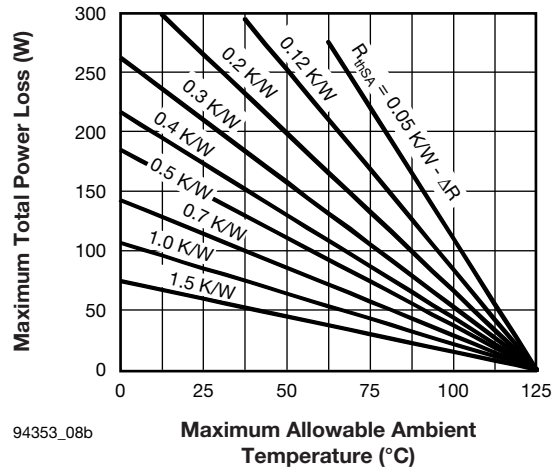
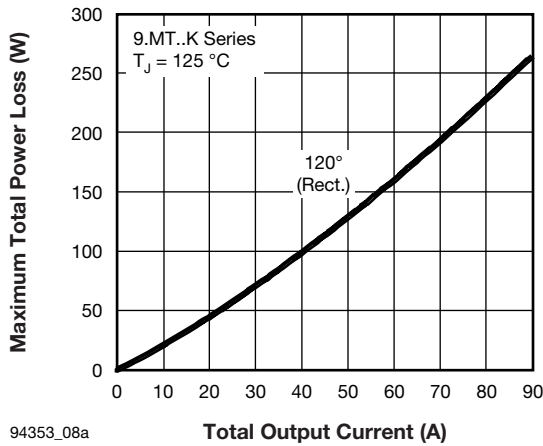

Fig. 8 - Total Power Loss Characteristics

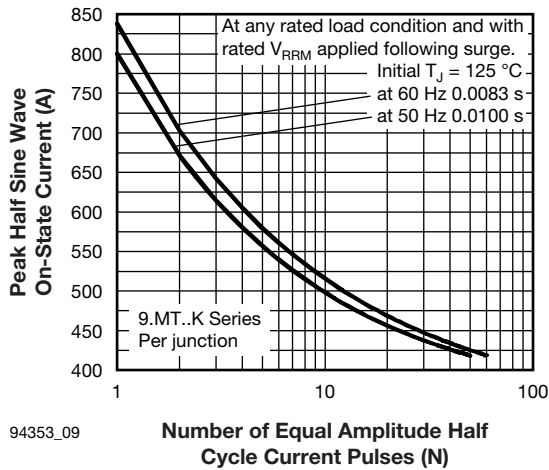

Fig. 9 - Maximum Non-Repetitive Surge Current

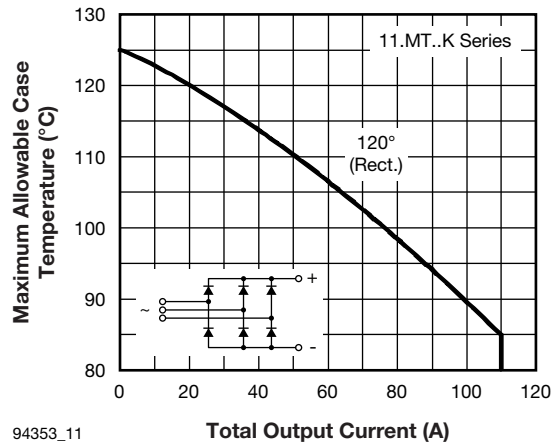

Fig. 11 - Current Ratings Characteristic

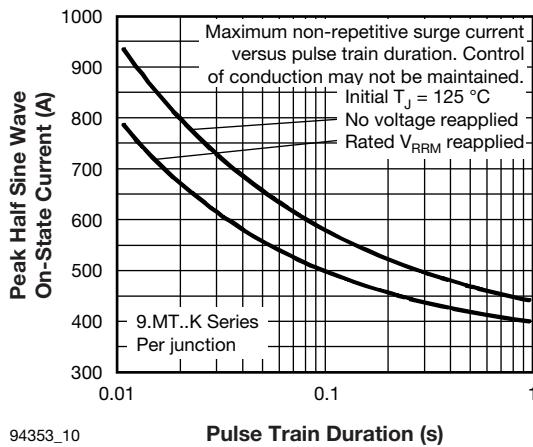

Fig. 10 - Maximum Non-Repetitive Surge Current

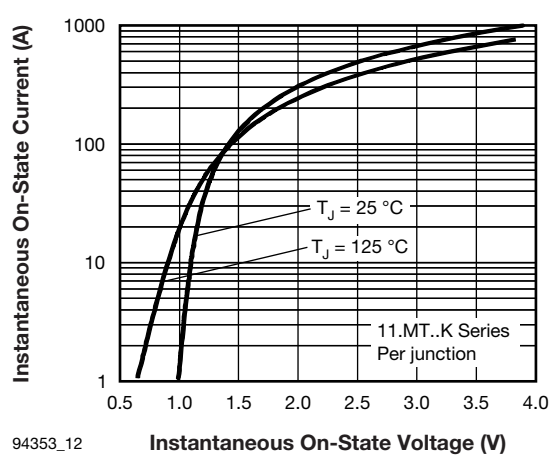
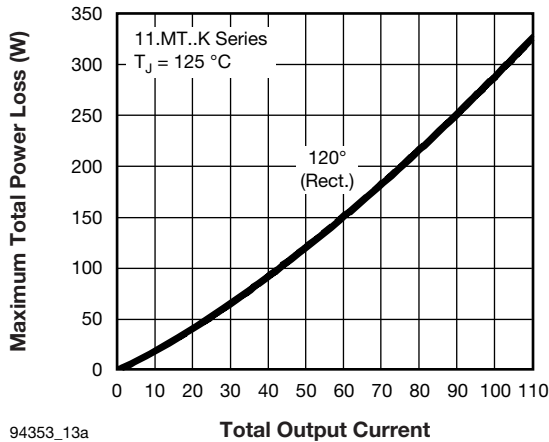
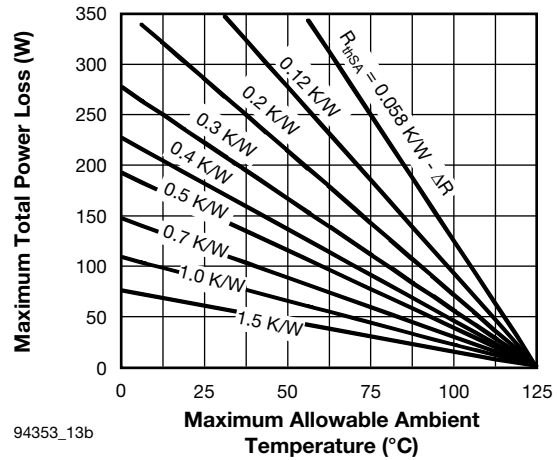

Fig. 12 - Forward Voltage Drop Characteristics



94353_13a



94353_13b

Fig. 13 - Total Power Loss Characteristics

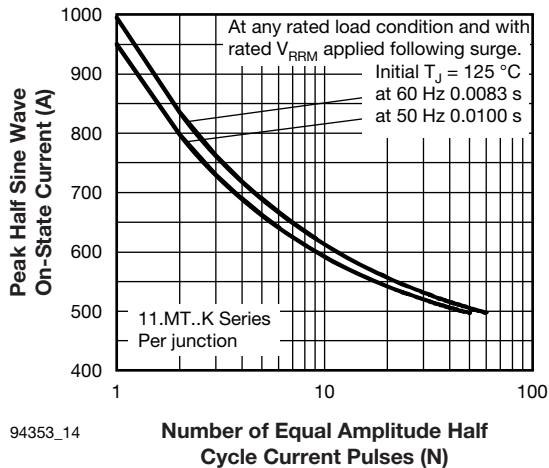

94353_14

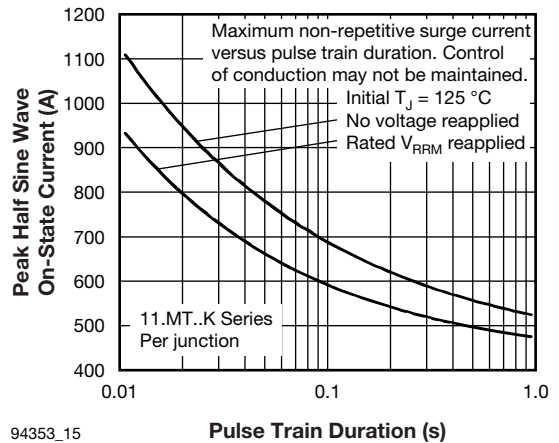

94353_15

Fig. 14 - Maximum Non-Repetitive Surge Current

Fig. 15 - Maximum Non-Repetitive Surge Current

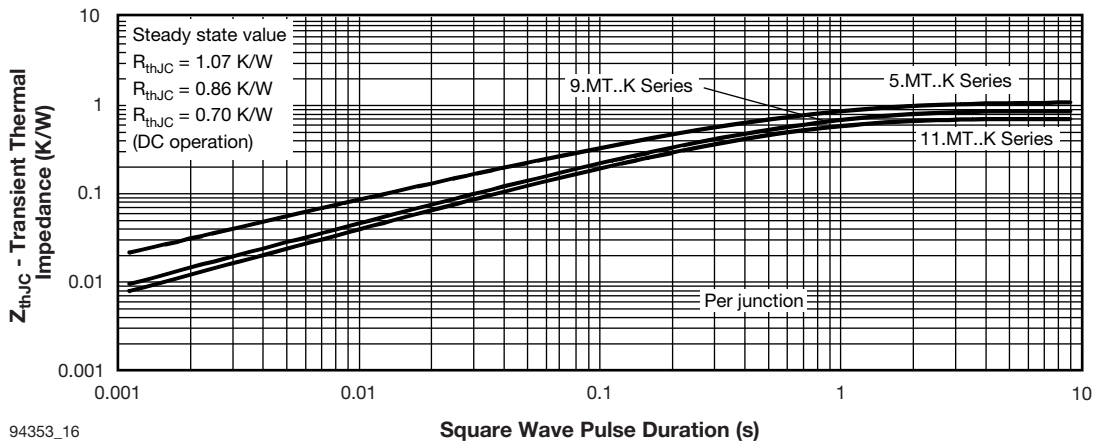

94353_16

Fig. 16 - Thermal Impedance Z_{thJC} Characteristics

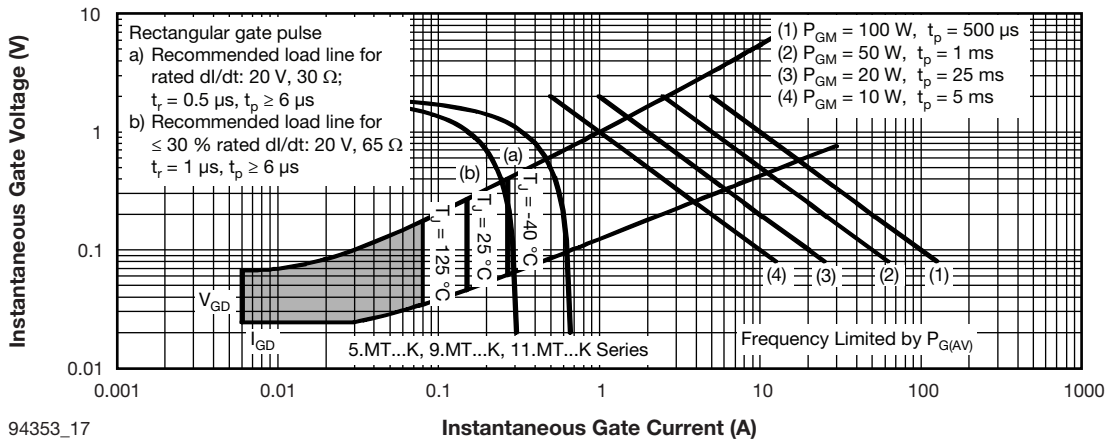

94353_17

Fig. 17 - Gate Characteristics

ORDERING INFORMATION TABLE

Device code	VS-	11	3	MT	160	K	S90	PbF
	①	②	③	④	⑤	⑥	⑦	

- 1** - Vishay Semiconductors product
- 2** - Current rating code:
 - 5 = 55 A (average)
 - 9 = 90 A (average)
 - 11 = 110 A (average)
- 3** - Circuit configuration code:
 - 1 = negative half-controlled bridge
 - 2 = positive half-controlled bridge
 - 3 = full-controlled bridge
- 4** - Essential part number
- 5** - Voltage code x 10 = V_{RRM} (see Voltage Ratings table)
- 6** - Critical dV/dt :
 - None = 500 V/ μs (standard value)
 - S90 = 1000 V/ μs (special selection)
- 7** - PbF = Lead (Pb)-free

Note

- To order the optional hardware go to www.vishay.com/doc?95172

CIRCUIT CONFIGURATION

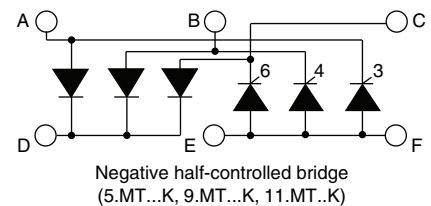
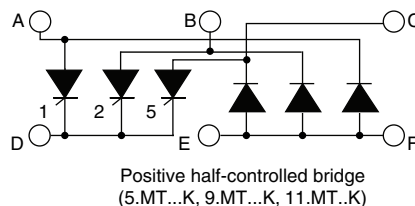
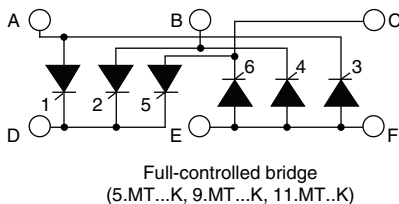

LINKS TO RELATED DOCUMENTS

Dimensions

www.vishay.com/doc?95004

MTK (with and without optional barrier)

DIMENSIONS WITH OPTIONAL BARRIERS in millimeters (inches)

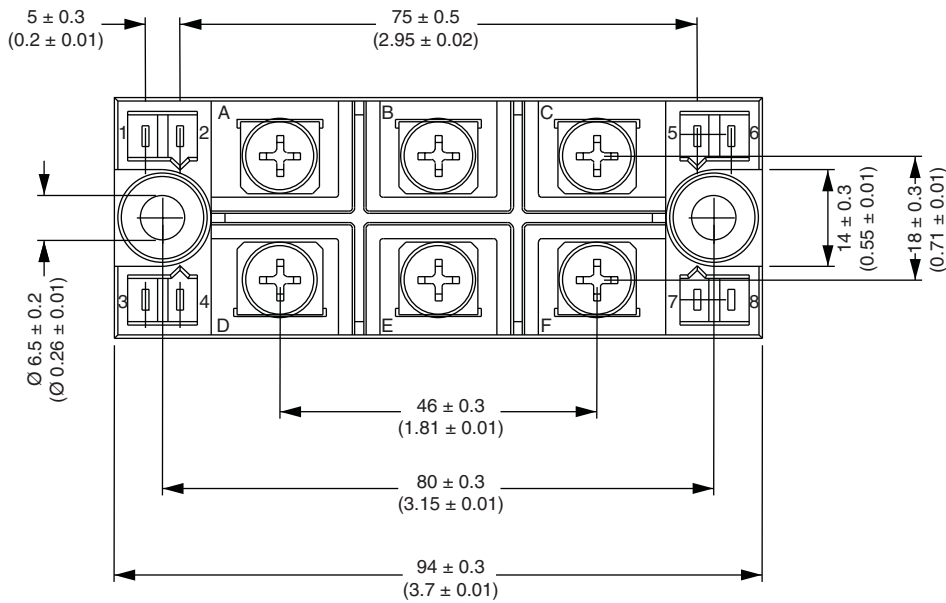
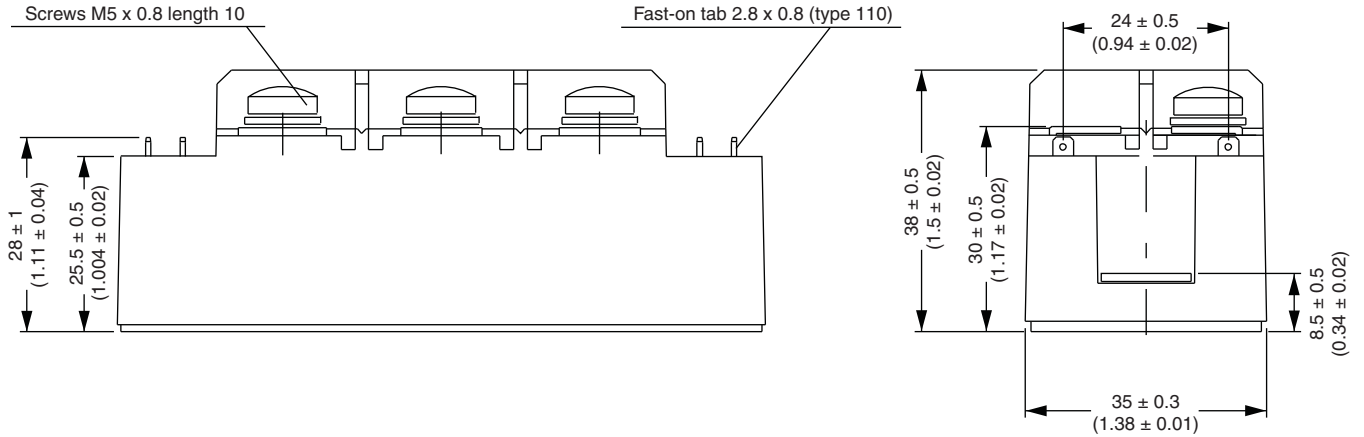

Outline Dimensions

Vishay Semiconductors MTK (with and without optional barrier)



DIMENSIONS WITHOUT OPTIONAL BARRIERS in millimeters (inches)

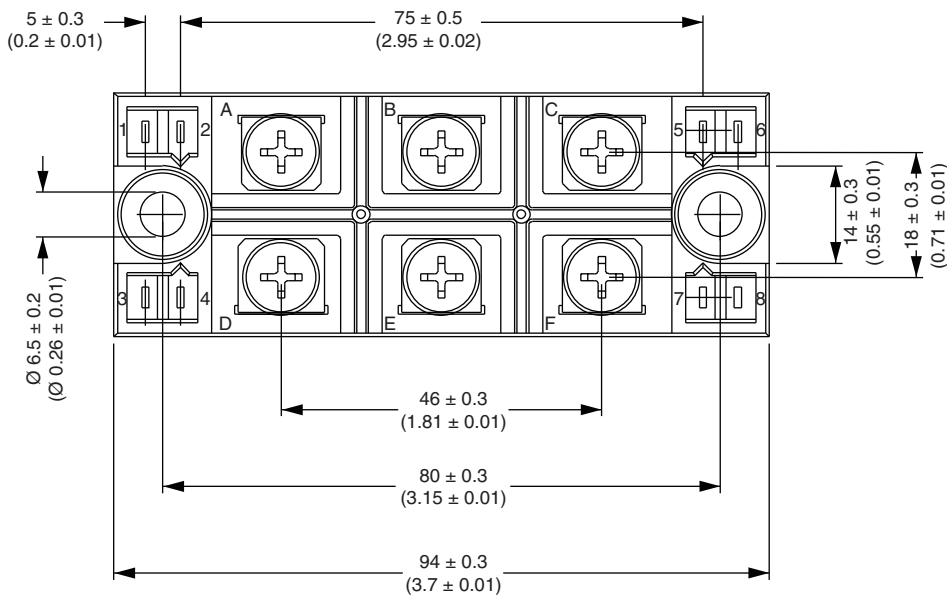
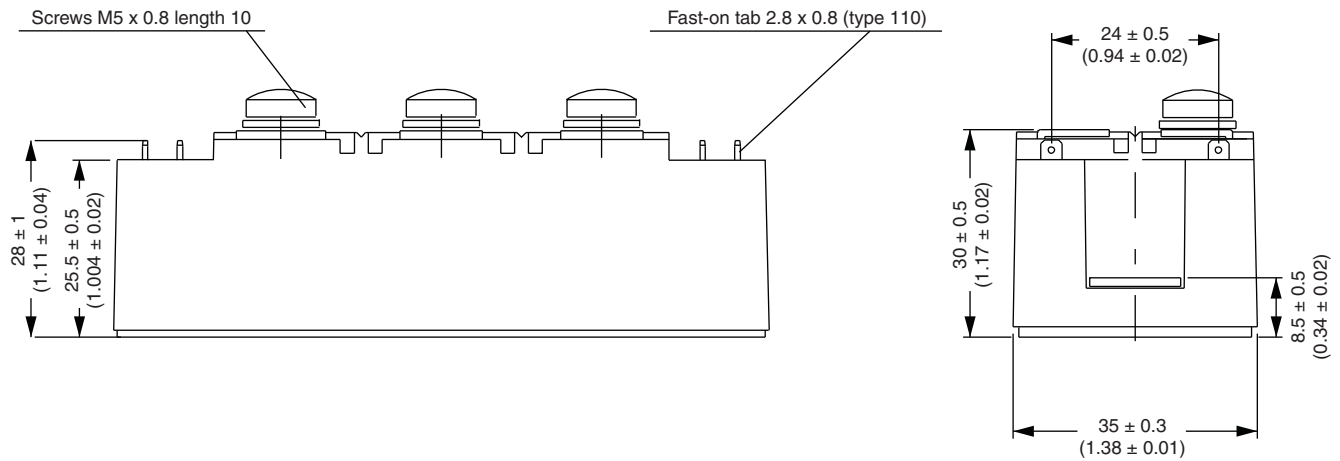



Disclaimer

ALL PRODUCT, PRODUCT SPECIFICATIONS AND DATA ARE SUBJECT TO CHANGE WITHOUT NOTICE TO IMPROVE RELIABILITY, FUNCTION OR DESIGN OR OTHERWISE.

Vishay Intertechnology, Inc., its affiliates, agents, and employees, and all persons acting on its or their behalf (collectively, "Vishay"), disclaim any and all liability for any errors, inaccuracies or incompleteness contained in any datasheet or in any other disclosure relating to any product.

Vishay makes no warranty, representation or guarantee regarding the suitability of the products for any particular purpose or the continuing production of any product. To the maximum extent permitted by applicable law, Vishay disclaims (i) any and all liability arising out of the application or use of any product, (ii) any and all liability, including without limitation special, consequential or incidental damages, and (iii) any and all implied warranties, including warranties of fitness for particular purpose, non-infringement and merchantability.

Statements regarding the suitability of products for certain types of applications are based on Vishay's knowledge of typical requirements that are often placed on Vishay products in generic applications. Such statements are not binding statements about the suitability of products for a particular application. It is the customer's responsibility to validate that a particular product with the properties described in the product specification is suitable for use in a particular application. Parameters provided in datasheets and / or specifications may vary in different applications and performance may vary over time. All operating parameters, including typical parameters, must be validated for each customer application by the customer's technical experts. Product specifications do not expand or otherwise modify Vishay's terms and conditions of purchase, including but not limited to the warranty expressed therein.

Hyperlinks included in this datasheet may direct users to third-party websites. These links are provided as a convenience and for informational purposes only. Inclusion of these hyperlinks does not constitute an endorsement or an approval by Vishay of any of the products, services or opinions of the corporation, organization or individual associated with the third-party website. Vishay disclaims any and all liability and bears no responsibility for the accuracy, legality or content of the third-party website or for that of subsequent links.

Except as expressly indicated in writing, Vishay products are not designed for use in medical, life-saving, or life-sustaining applications or for any other application in which the failure of the Vishay product could result in personal injury or death. Customers using or selling Vishay products not expressly indicated for use in such applications do so at their own risk. Please contact authorized Vishay personnel to obtain written terms and conditions regarding products designed for such applications.

No license, express or implied, by estoppel or otherwise, to any intellectual property rights is granted by this document or by any conduct of Vishay. Product names and markings noted herein may be trademarks of their respective owners.