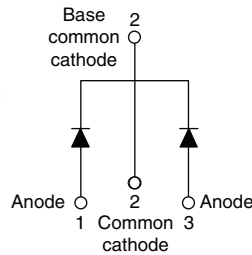

High Performance Schottky Rectifier, 2 x 15 A

TO-220AB 3L

FEATURES

- 150 °C T_J operation
- Very low forward voltage drop
- High frequency operation
- High purity, high temperature epoxy encapsulation for enhanced mechanical strength and moisture resistance
- Guard ring for enhanced ruggedness and long term reliability
- Designed and qualified according to JEDEC®-JESD 47
- Material categorization: for definitions of compliance please see www.vishay.com/doc?99912

RoHS
 COMPLIANT
 HALOGEN
FREE

| PRIMARY CHARACTERISTICS | |
|-------------------------|-----------------|
| $I_{F(AV)}$ | 2 x 15 A |
| V_R | 50 V, 60 V |
| V_F at I_F | 0.56 V |
| I_{RM} typ. | 45 mA at 125 °C |
| T_J max. | 150 °C |
| E_{AS} | 13 mJ |
| Package | TO-220AB 3L |
| Circuit configuration | Common cathode |

DESCRIPTION

This center tap Schottky rectifier has been optimized for very low forward voltage drop, with moderate leakage. The proprietary barrier technology allows for reliable operation up to 150 °C junction temperature. Typical applications are in switching power supplies, converters, freewheeling diodes, and reverse battery protection.

| MAJOR RATINGS AND CHARACTERISTICS | | | |
|-----------------------------------|--|-------------|-------|
| SYMBOL | CHARACTERISTICS | VALUES | UNITS |
| $I_{F(AV)}$ | Rectangular waveform | 30 | A |
| V_{RRM} | | 50/60 | V |
| I_{FSM} | $t_p = 5 \mu s$ sine | 1000 | A |
| V_F | 15 A_{pk} , $T_J = 125$ °C (per leg) | 0.56 | V |
| T_J | Range | -55 to +150 | °C |

| VOLTAGE RATINGS | | | | |
|--------------------------------------|-----------|----------------|----------------|-------|
| PARAMETER | SYMBOL | VS-30CTQ050-M3 | VS-30CTQ060-M3 | UNITS |
| Maximum DC reverse voltage | V_R | 50 | 60 | V |
| Maximum working peak reverse voltage | V_{RWM} | | | |

| ABSOLUTE MAXIMUM RATINGS | | | | | |
|--|-------------|---|---|--------|-------|
| PARAMETER | SYMBOL | TEST CONDITIONS | | VALUES | UNITS |
| Maximum average forward current, see fig. 5 <small>per device per leg</small> | $I_{F(AV)}$ | 50 % duty cycle at $T_C = 105$ °C, rectangular waveform | | 30 | A |
| | | | | 15 | |
| Maximum peak one cycle non-repetitive surge current per leg, see fig. 7 | I_{FSM} | 5 μs sine or 3 μs rect. pulse | Following any rated load condition and with rated V_{RRM} applied | 1000 | |
| | | 10 ms sine or 6 ms rect. pulse | | 260 | |
| Non-repetitive avalanche energy per leg | E_{AS} | $T_J = 25$ °C, $I_{AS} = 1.50$ A, $L = 11.5$ mH | | 13 | mJ |
| Repetitive avalanche current per leg | I_{AR} | Current decaying linearly to zero in 1 μs Frequency limited by T_J maximum $V_A = 1.5 \times V_R$ typical | | 1.50 | A |



| ELECTRICAL SPECIFICATIONS | | | | | |
|--|----------------|---|-----------------------------------|--------|------------------|
| PARAMETER | SYMBOL | TEST CONDITIONS | | VALUES | UNITS |
| Maximum forward voltage drop per leg See fig. 1 | $V_{FM}^{(1)}$ | 15 A | $T_J = 25\text{ }^\circ\text{C}$ | 0.62 | V |
| | | 30 A | | 0.82 | |
| | | 15 A | $T_J = 125\text{ }^\circ\text{C}$ | 0.56 | |
| | | 30 A | | 0.71 | |
| Maximum reverse leakage current per leg | $I_{RM}^{(1)}$ | $T_J = 25\text{ }^\circ\text{C}$ | $V_R = \text{Rated } V_R$ | 0.80 | mA |
| | | $T_J = 125\text{ }^\circ\text{C}$ | | 160 | |
| Typical reverse leakage current | $I_{RM}^{(1)}$ | $T_J = 125\text{ }^\circ\text{C}$ | $V_R = \text{Rated } V_R$ | 45 | mA |
| Threshold voltage | $V_{F(TO)}$ | $T_J = T_J \text{ maximum}$ | | 0.39 | V |
| Forward slope resistance | r_t | | | 8.47 | m Ω |
| Maximum junction capacitance per leg | C_T | $V_R = 5 V_{DC}$ (test signal range 100 kHz to 1 MHz) 25 $^\circ\text{C}$ | | 720 | pF |
| Typical series inductance per leg | L_S | Measured lead to lead 5 mm from package body | | 8.0 | nH |
| Maximum voltage rate of change | dV/dt | Rated V_R | | 10 000 | V/ μs |

Note(1) Pulse width < 300 μs , duty cycle < 2 %

| THERMAL - MECHANICAL SPECIFICATIONS | | | | | |
|--|--------------------|--------------------------------------|--|-------------|------------------------|
| PARAMETER | SYMBOL | TEST CONDITIONS | | VALUES | UNITS |
| Maximum junction and storage temperature range | T_J, T_{Stg} | | | -55 to +150 | $^\circ\text{C}$ |
| Maximum thermal resistance, junction to case per leg | R_{thJC} | DC operation | | 3.25 | $^\circ\text{C/W}$ |
| Maximum thermal resistance, junction to case per package | | | | 1.63 | |
| Typical thermal resistance, case to heatsink | R_{thCS} | Mounting surface, smooth and greased | | 0.50 | |
| Approximate weight | | | | 2 | g |
| | | | | 0.07 | oz. |
| Mounting torque | minimum maximum | | | 6 (5) | kgf · cm (lbf · in) |
| | | | | 12 (10) | |
| Marking device | | Case style TO-220AB 3L | | 30CTQ050 | |
| | | | | 30CTQ060 | |

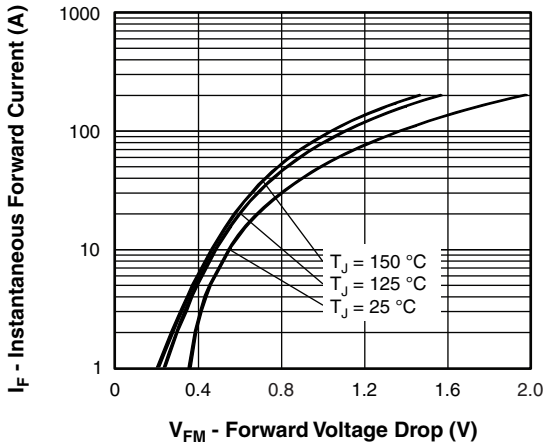

Fig. 1 - Maximum Forward Voltage Drop Characteristics (Per Leg)

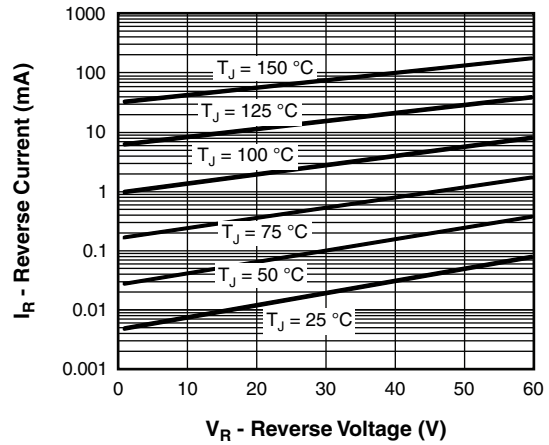

Fig. 2 - Typical Values of Reverse Current vs. Reverse Voltage (Per Leg)

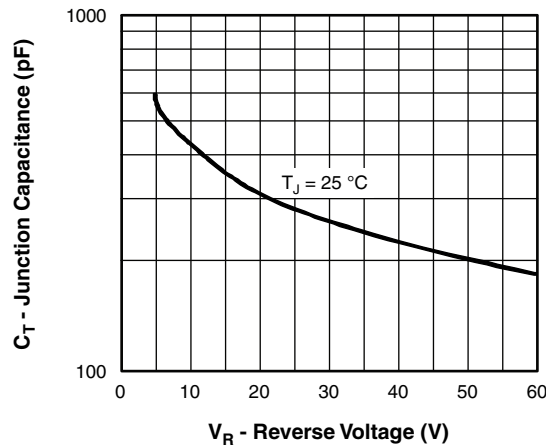

Fig. 3 - Typical Junction Capacitance vs. Reverse Voltage (Per Leg)

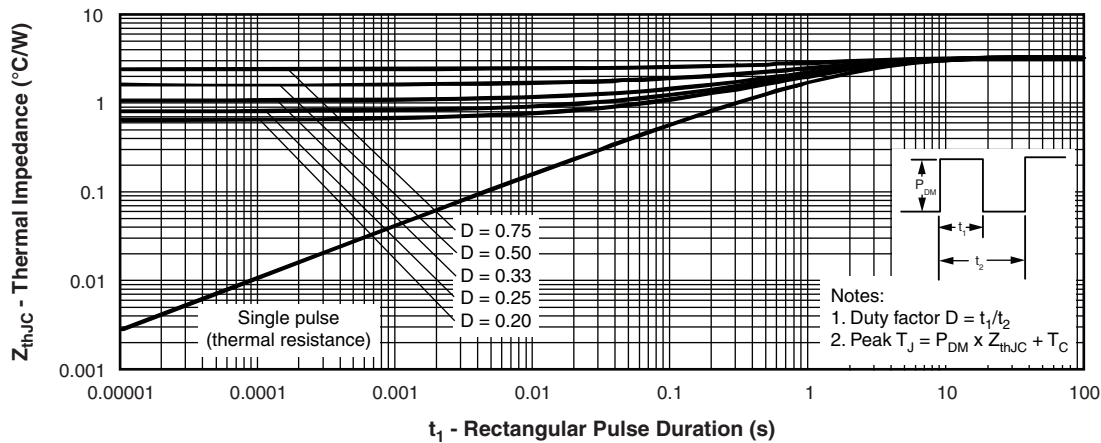

Fig. 4 - Maximum Thermal Impedance Z_{thJC} Characteristics (Per Leg)

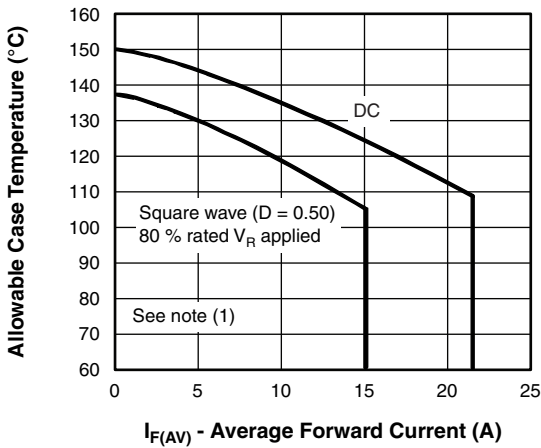

Fig. 5 - Maximum Allowable Case Temperature vs. Average Forward Current (Per Leg)

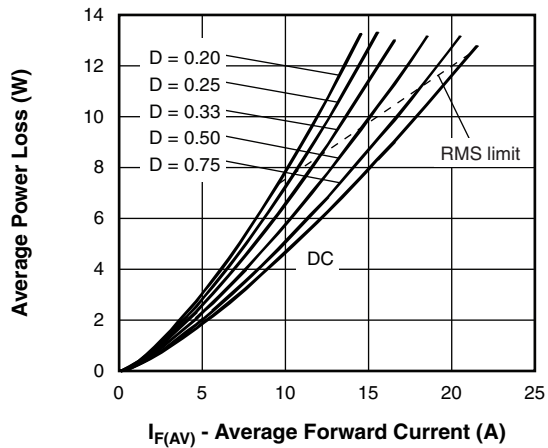

Fig. 6 - Forward Power Loss Characteristics (Per Leg)

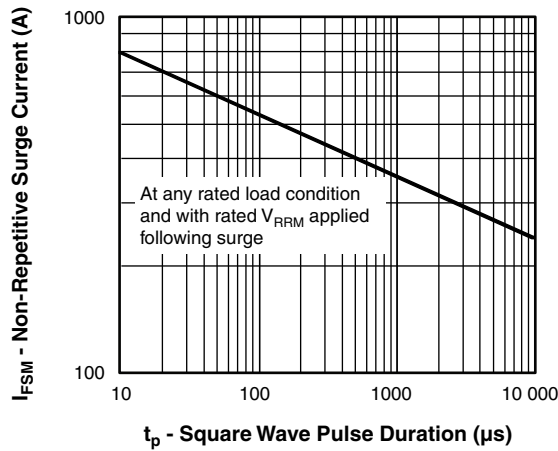

Fig. 7 - Maximum Non-Repetitive Surge Current (Per Leg)

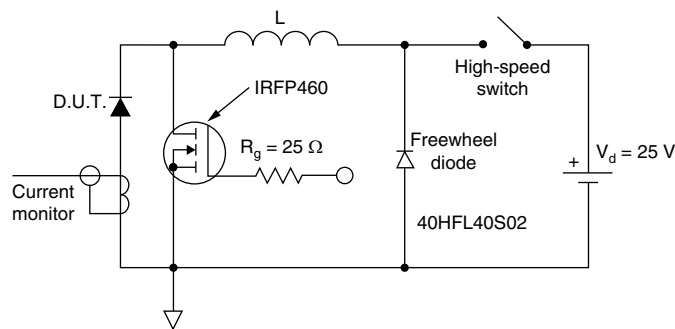

Fig. 8 - Unclamped Inductive Test Circuit

Note

- (1) Formula used: $T_C = T_J - (P_d + P_{dREV}) \times R_{thJC}$;
 P_d = forward power loss = $I_{F(AV)} \times V_{FM}$ at $(I_{F(AV)}/D)$ (see fig. 6);
 P_{dREV} = inverse power loss = $V_{R1} \times I_R (1 - D)$; I_R at $V_{R1} = 10$ V



ORDERING INFORMATION TABLE

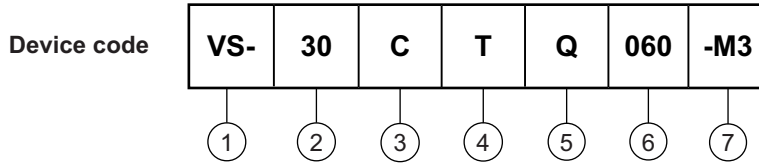

- 1** - Vishay Semiconductors product
- 2** - Current rating (30 = 30 A)
- 3** - Circuit configuration:
C = common cathode
- 4** - Package:
T = TO-220
- 5** - Schottky "Q" series
- 6** - Voltage ratings —————

| |
|------------|
| 050 = 50 V |
| 060 = 60 V |
- 7** - Environmental digit
-M3 = halogen-free, RoHS-compliant, and termination lead (Pb)-free

| ORDERING INFORMATION (Example) | | |
|--------------------------------|---------------|--------------------------|
| PREFERRED P/N | BASE QUANTITY | PACKAGING DESCRIPTION |
| VS-30CTQ050-M3 | 50 | Antistatic plastic tubes |
| VS-30CTQ060-M3 | 50 | Antistatic plastic tubes |

| LINKS TO RELATED DOCUMENTS | |
|----------------------------|--|
| Dimensions | www.vishay.com/doc?96154 |
| Part marking information | www.vishay.com/doc?95028 |



TO-220AB 3L

DIMENSIONS in millimeters and inches

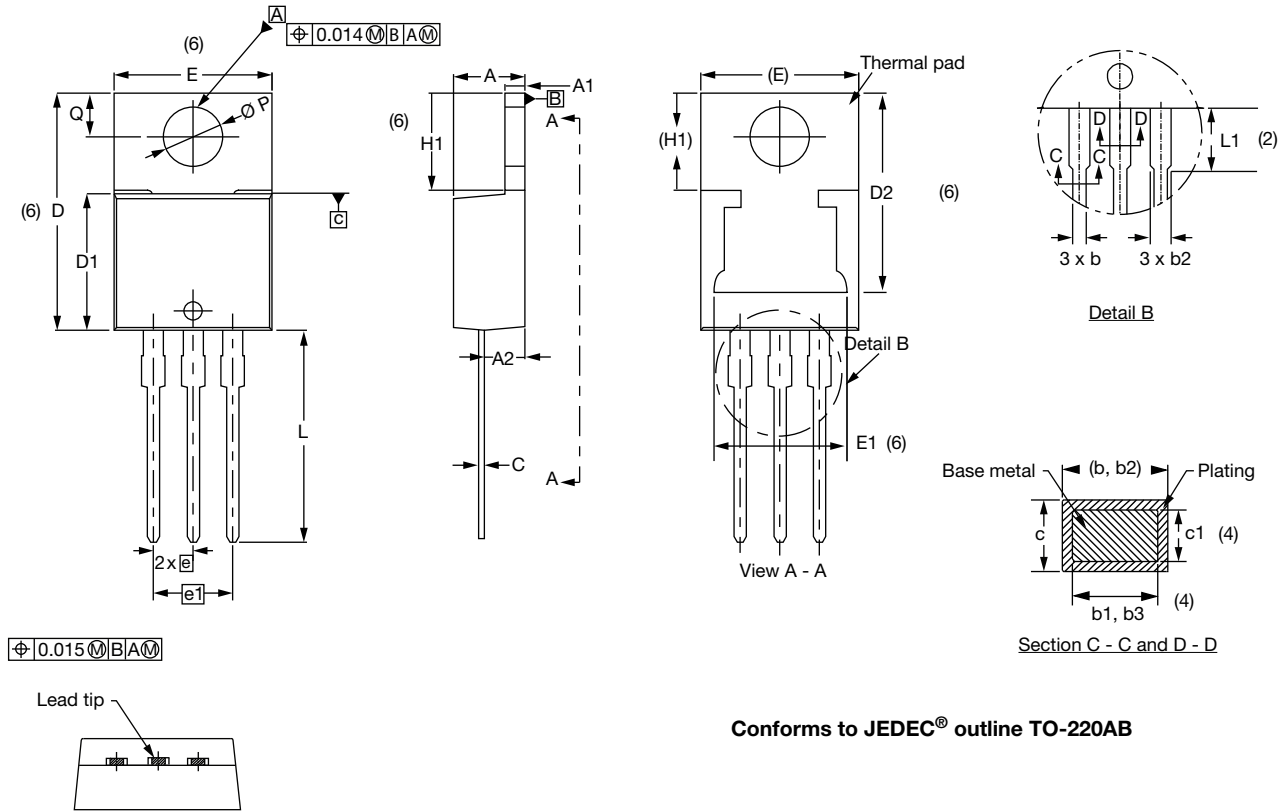

Conforms to JEDEC® outline TO-220AB

| SYMBOL | MILLIMETERS | | INCHES | | NOTES | SYMBOL | MILLIMETERS | | INCHES | | NOTES |
|--------|-------------|-------|--------|-------|-------|--------|-------------|-------|--------|-------|-------|
| | MIN. | MAX. | MIN. | MAX. | | | MIN. | MAX. | MIN. | MAX. | |
| A | 4.25 | 4.65 | 0.167 | 0.183 | | D2 | 11.68 | 13.30 | 0.460 | 0.524 | 6, 7 |
| A1 | 1.14 | 1.40 | 0.045 | 0.055 | | E | 10.11 | 10.51 | 0.398 | 0.414 | 3, 6 |
| A2 | 2.50 | 2.92 | 0.098 | 0.115 | | E1 | 6.86 | 8.89 | 0.270 | 0.350 | 6 |
| b | 0.69 | 1.01 | 0.027 | 0.040 | | e | 2.41 | 2.67 | 0.095 | 0.105 | |
| b1 | 0.38 | 0.97 | 0.015 | 0.038 | 4 | e1 | 4.88 | 5.28 | 0.192 | 0.208 | |
| b2 | 1.20 | 1.73 | 0.047 | 0.068 | | H1 | 6.09 | 6.48 | 0.240 | 0.255 | 6 |
| b3 | 1.14 | 1.73 | 0.045 | 0.068 | 4 | L | 13.52 | 14.02 | 0.532 | 0.552 | |
| c | 0.36 | 0.61 | 0.014 | 0.024 | | L1 | 3.32 | 3.82 | 0.131 | 0.150 | 2 |
| c1 | 0.36 | 0.56 | 0.014 | 0.022 | 4 | ∅ P | 3.54 | 3.91 | 0.139 | 0.154 | |
| D | 14.85 | 15.35 | 0.585 | 0.604 | 3 | Q | 2.60 | 3.00 | 0.102 | 0.118 | |
| D1 | 8.38 | 9.02 | 0.330 | 0.355 | | | | | | | |

Notes

- (1) Dimensioning and tolerancing as per ASME Y14.5M-1994
- (2) Lead dimension and finish uncontrolled in L1
- (3) Dimension D, D1, and E do not include mold flash. Mold flash shall not exceed 0.127 mm (0.005") per side. These dimensions are measured at the outermost extremes of the plastic body
- (4) Dimension b1, b3, and c1 apply to base metal only
- (5) Controlling dimensions: inches
- (6) Thermal pad contour optional within dimensions E, H1, D2, and E1
- (7) Outline conforms to JEDEC® TO-220, except D2



Disclaimer

ALL PRODUCT, PRODUCT SPECIFICATIONS AND DATA ARE SUBJECT TO CHANGE WITHOUT NOTICE TO IMPROVE RELIABILITY, FUNCTION OR DESIGN OR OTHERWISE.

Vishay Intertechnology, Inc., its affiliates, agents, and employees, and all persons acting on its or their behalf (collectively, "Vishay"), disclaim any and all liability for any errors, inaccuracies or incompleteness contained in any datasheet or in any other disclosure relating to any product.

Vishay makes no warranty, representation or guarantee regarding the suitability of the products for any particular purpose or the continuing production of any product. To the maximum extent permitted by applicable law, Vishay disclaims (i) any and all liability arising out of the application or use of any product, (ii) any and all liability, including without limitation special, consequential or incidental damages, and (iii) any and all implied warranties, including warranties of fitness for particular purpose, non-infringement and merchantability.

Statements regarding the suitability of products for certain types of applications are based on Vishay's knowledge of typical requirements that are often placed on Vishay products in generic applications. Such statements are not binding statements about the suitability of products for a particular application. It is the customer's responsibility to validate that a particular product with the properties described in the product specification is suitable for use in a particular application. Parameters provided in datasheets and / or specifications may vary in different applications and performance may vary over time. All operating parameters, including typical parameters, must be validated for each customer application by the customer's technical experts. Product specifications do not expand or otherwise modify Vishay's terms and conditions of purchase, including but not limited to the warranty expressed therein.

Hyperlinks included in this datasheet may direct users to third-party websites. These links are provided as a convenience and for informational purposes only. Inclusion of these hyperlinks does not constitute an endorsement or an approval by Vishay of any of the products, services or opinions of the corporation, organization or individual associated with the third-party website. Vishay disclaims any and all liability and bears no responsibility for the accuracy, legality or content of the third-party website or for that of subsequent links.

Vishay products are not designed for use in life-saving or life-sustaining applications or any application in which the failure of the Vishay product could result in personal injury or death unless specifically qualified in writing by Vishay. Customers using or selling Vishay products not expressly indicated for use in such applications do so at their own risk. Please contact authorized Vishay personnel to obtain written terms and conditions regarding products designed for such applications.

No license, express or implied, by estoppel or otherwise, to any intellectual property rights is granted by this document or by any conduct of Vishay. Product names and markings noted herein may be trademarks of their respective owners.