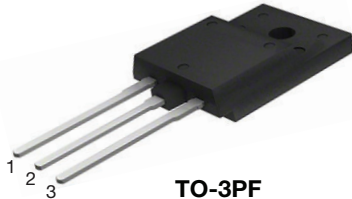
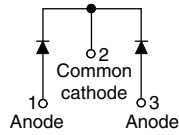

Ultrafast Soft Recovery Diode, 2 x 15 A FRED Pt[®] Gen 4

TO-3PF

FEATURES

- Gen 4 FRED Pt technology
- Low I_{RRM} and reverse recovery charge
- Very low forward voltage drop
- Polyimide passivated chip for high reliability standard
- Fully isolated package ($V_{INS} = 2500 V_{RMS}$)
- 175 °C operating junction temperature
- Material categorization: for definitions of compliance please see www.vishay.com/doc?99912

RoHS
COMPLIANT
HALOGEN
FREE
PRIMARY CHARACTERISTICS

$I_{F(AV)}$ per leg	15 A
V_R	600 V
V_F at I_F	1.08 V
t_{rr} typ.	37 ns
T_J max.	175 °C
Package	TO-3PF
Circuit configuration	Common cathode

DESCRIPTION

Gen 4 Fred Pt technology, state of the art, ultralow V_F , soft switching optimized for Discontinuous (Critical) Mode (DCM) and IGBT F/W diode.

The minimized conduction loss, optimized stored charge and low recovery current minimize the switching losses and reduce over dissipation in the switching element and snubbers.

ABSOLUTE MAXIMUM RATINGS

PARAMETER	SYMBOL	TEST CONDITIONS	MAX.	UNITS
Peak repetitive reverse voltage	V_{RRM}		600	V
Average rectified forward current, per leg	$I_{F(AV)}$	$T_C = 120\text{ °C}$	15	A
Non-repetitive peak surge current, per leg	I_{FSM}	$T_C = 25\text{ °C}$, $t_p = 8.3\text{ ms}$ half sine wave	180	
Operating junction and storage temperature	T_J, T_{Stg}		-55 to +175	°C

ELECTRICAL SPECIFICATIONS ($T_J = 25\text{ °C}$ unless otherwise specified)

PARAMETER	SYMBOL	TEST CONDITIONS	MIN.	TYP.	MAX.	UNITS
Breakdown voltage, blocking voltage	V_{BR}, V_R	$I_R = 100\text{ }\mu\text{A}$	600	-	-	V
Forward voltage	V_F	$I_F = 15\text{ A}$	-	1.3	1.6	
		$I_F = 30\text{ A}$	-	1.46	1.87	
		$I_F = 15\text{ A}, T_J = 150\text{ °C}$	-	1.08	1.3	
		$I_F = 30\text{ A}, T_J = 150\text{ °C}$	-	1.32	-	
Reverse leakage current	I_R	$V_R = V_R$ rated	-	-	15	μA
		$T_J = 125\text{ °C}$, $V_R = V_R$ rated	-	-	500	
Junction capacitance	C_T	$V_R = 600\text{ V}$	-	15	-	pF



DYNAMIC RECOVERY CHARACTERISTICS (T _J = 25 °C unless otherwise specified)							
PARAMETER	SYMBOL	TEST CONDITIONS		MIN.	TYP.	MAX.	UNITS
Reverse recovery time, per leg	t _{rr}	I _F = 1 A, di _F /dt = 100 A/μs, V _R = 30 V		-	37	-	ns
		T _J = 25 °C	I _F = 15 A di _F /dt = 1000 A/μs V _R = 400 V	-	73	-	
		T _J = 125 °C		-	83	-	
Peak recovery current, per leg	I _{RRM}	T _J = 25 °C	I _F = 15 A di _F /dt = 1000 A/μs V _R = 400 V	-	13	-	A
		T _J = 125 °C		-	21	-	
Reverse recovery charge, per leg	Q _{rr}	T _J = 25 °C	I _F = 15 A di _F /dt = 1000 A/μs V _R = 400 V	-	500	-	nC
		T _J = 125 °C		-	1100	-	

THERMAL - MECHANICAL SPECIFICATIONS							
PARAMETER	SYMBOL	TEST CONDITIONS		MIN.	TYP.	MAX.	UNITS
Thermal resistance, junction to case	R _{thJC}			-	-	3	°C/W
Thermal resistance, case to heatsink	R _{thCS}			-	0.5	-	
Weight				-	6.2	-	g
				-	0.21	-	oz.
Mounting torque				4.0 (3.5)	-	6.0 (5.3)	kgf · cm (lbf · in)
Marking device		Case style TO-3PF		C4ZU3006FP			

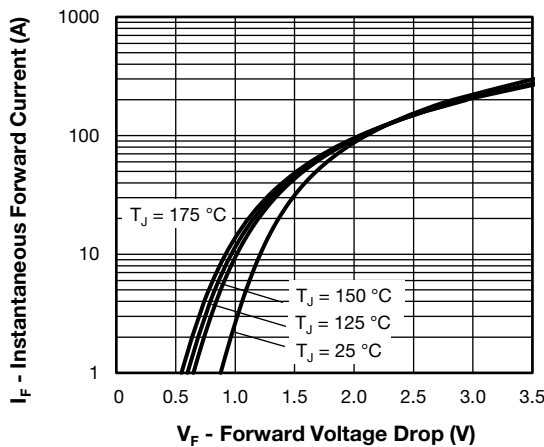

Fig. 1 - Typical Forward Voltage Drop Characteristics

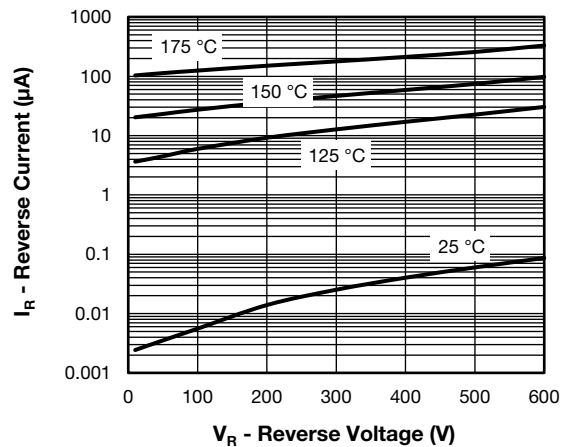

Fig. 2 - Typical Values of Reverse Current vs. Reverse Voltage

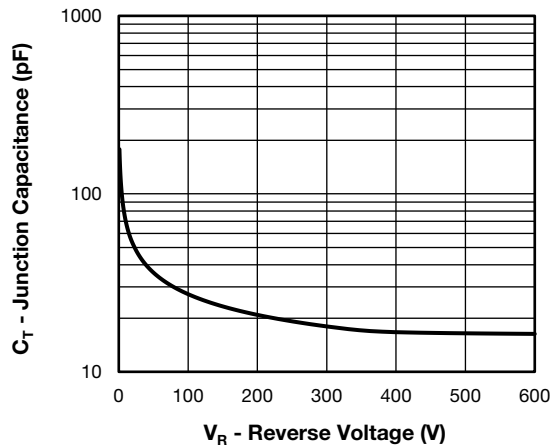

Fig. 3 - Typical Junction Capacitance vs. Reverse Voltage

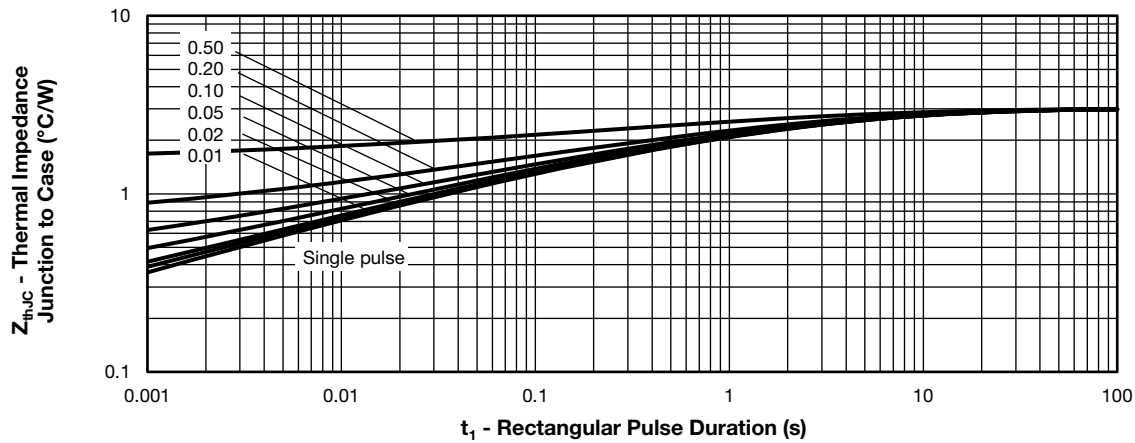

Fig. 4 - Max. Thermal Impedance Z_{thJC} Characteristics

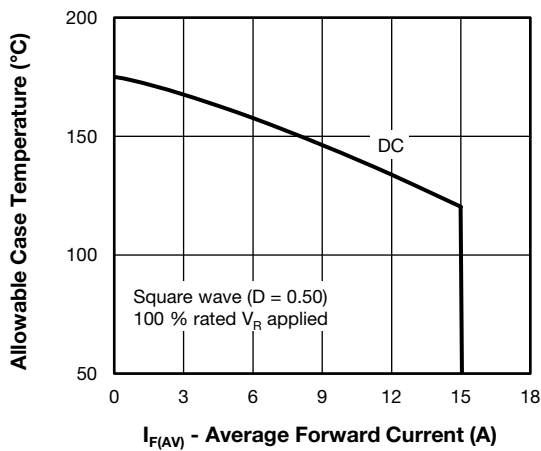

Fig. 5 - Maximum Allowable Case Temperature vs. Average Forward Current

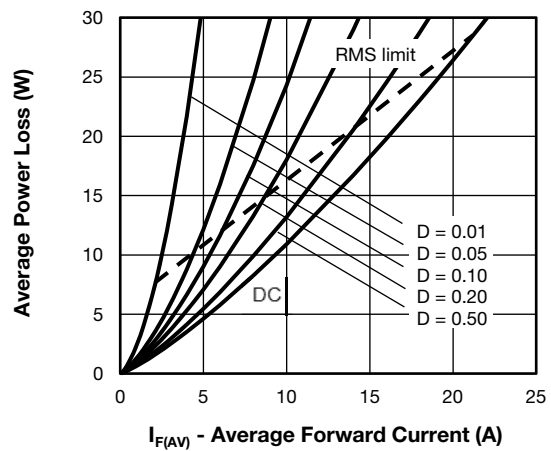

Fig. 6 - Forward Power Loss Characteristics

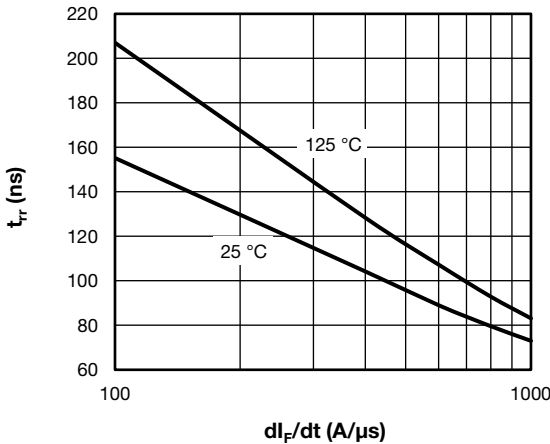

Fig. 7 - Typical Reverse Recovery Time vs. di_F/dt

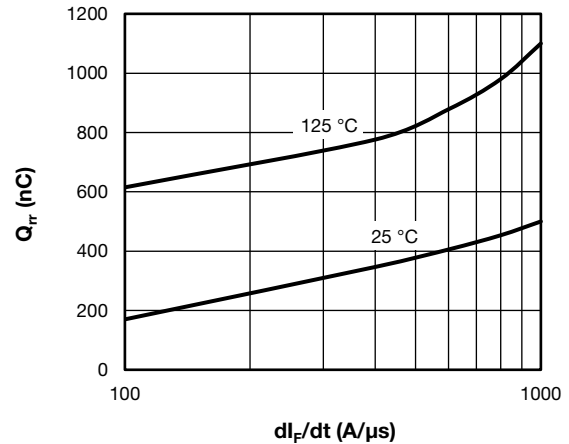

Fig. 8 - Typical Stored Charge vs. di_F/dt

ORDERING INFORMATION TABLE

Device code	VS-	C	4	Z	U	30	06	FP	-M3
	①	②	③	④	⑤	⑥	⑦	⑧	⑨
	1	-	Vishay Semiconductors product						
	2	-	Circuit configuration: C = common cathode						
	3	-	FRED Pt Gen 4						
	4	-	Z = TO-3PF package						
	5	-	Process type: U = ultrafast recovery						
	6	-	Current rating (30 = 2 x 15 A)						
	7	-	Voltage rating (06 = 600 V)						
	8	-	FULL-PAK						
	9	-	Environmental digit: -M3 = halogen-free, RoHS-compliant, terminations lead (Pb)-free						

ORDERING INFORMATION (Example)			
PREFERRED P/N	QUANTITY PER TUBE	MINIMUM ORDER QUANTITY	PACKAGING DESCRIPTION
VS-C4ZU3006FP-M3	25	300	Antistatic plastic tube

LINKS TO RELATED DOCUMENTS		
Dimensions	TO-3PF	www.vishay.com/doc?96691
Part marking information	TO-3PF	www.vishay.com/doc?96690



TO-3PF

DIMENSIONS in millimeters

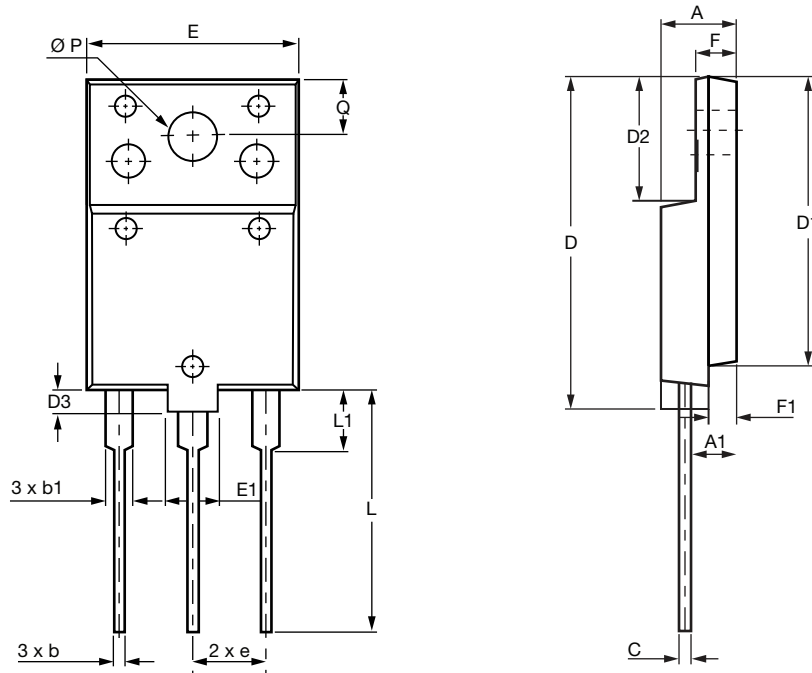

SYMBOL	MIN.	NOM.	MAX.
A	5.30	5.50	5.70
A1	3.10	3.30	3.50
b	0.65	0.85	0.95
b1	1.80	2.00	2.20
c	0.80	0.90	1.10
D	26.30	26.50	26.70
D1	22.80	23.00	23.20
D2	9.80	10.00	10.20
D3	1.80	2.00	2.20
E	15.30	15.50	15.70
E1	3.80	4.00	4.20
e	5.45 BSC		
F	2.80	3.00	3.20
F1	1.80	2.00	2.20
L	19.10	19.30	19.50
L1	4.20	4.50	5.20
Q	4.30	4.50	4.70
Ø P	3.40	3.60	3.80



Disclaimer

ALL PRODUCT, PRODUCT SPECIFICATIONS AND DATA ARE SUBJECT TO CHANGE WITHOUT NOTICE TO IMPROVE RELIABILITY, FUNCTION OR DESIGN OR OTHERWISE.

Vishay Intertechnology, Inc., its affiliates, agents, and employees, and all persons acting on its or their behalf (collectively, "Vishay"), disclaim any and all liability for any errors, inaccuracies or incompleteness contained in any datasheet or in any other disclosure relating to any product.

Vishay makes no warranty, representation or guarantee regarding the suitability of the products for any particular purpose or the continuing production of any product. To the maximum extent permitted by applicable law, Vishay disclaims (i) any and all liability arising out of the application or use of any product, (ii) any and all liability, including without limitation special, consequential or incidental damages, and (iii) any and all implied warranties, including warranties of fitness for particular purpose, non-infringement and merchantability.

Statements regarding the suitability of products for certain types of applications are based on Vishay's knowledge of typical requirements that are often placed on Vishay products in generic applications. Such statements are not binding statements about the suitability of products for a particular application. It is the customer's responsibility to validate that a particular product with the properties described in the product specification is suitable for use in a particular application. Parameters provided in datasheets and / or specifications may vary in different applications and performance may vary over time. All operating parameters, including typical parameters, must be validated for each customer application by the customer's technical experts. Product specifications do not expand or otherwise modify Vishay's terms and conditions of purchase, including but not limited to the warranty expressed therein.

Hyperlinks included in this datasheet may direct users to third-party websites. These links are provided as a convenience and for informational purposes only. Inclusion of these hyperlinks does not constitute an endorsement or an approval by Vishay of any of the products, services or opinions of the corporation, organization or individual associated with the third-party website. Vishay disclaims any and all liability and bears no responsibility for the accuracy, legality or content of the third-party website or for that of subsequent links.

Except as expressly indicated in writing, Vishay products are not designed for use in medical, life-saving, or life-sustaining applications or for any other application in which the failure of the Vishay product could result in personal injury or death. Customers using or selling Vishay products not expressly indicated for use in such applications do so at their own risk. Please contact authorized Vishay personnel to obtain written terms and conditions regarding products designed for such applications.

No license, express or implied, by estoppel or otherwise, to any intellectual property rights is granted by this document or by any conduct of Vishay. Product names and markings noted herein may be trademarks of their respective owners.