

“Half Bridge” Low $V_{CE(on)}$ IGBT INT-A-PAK, 100 A



INT-A-PAK IGBT

FEATURES

- Trench IGBT technology
- Gen 4 FRED Pt® technology anti-parallel diodes with ultra soft reverse recovery characteristics
- Very low conduction losses
- Al₂O₃ DBC
- UL approved file E78996 
- Designed for industrial level
- Material categorization: for definitions of compliance please see www.vishay.com/doc?99912

RoHS
COMPLIANT

BENEFITS

- Optimized for high current inverter stages (AC TIG welding machines)
- Direct mounting to heatsink
- Very low junction to case thermal resistance
- Low EMI

PRIMARY CHARACTERISTICS

V_{CES}	650 V
I_C DC, $T_C = 80\text{ }^\circ\text{C}$	185A
$V_{CE(on)}$ at 100 A, 25 °C	1.05 V
Chip level $V_{CE(on)}$ at 100 A, 25 °C	0.98 V
Speed	DC to 1 kHz
Package	INT-A-PAK
Circuit configuration	Half bridge

ABSOLUTE MAXIMUM RATINGS

PARAMETER	SYMBOL	TEST CONDITIONS	MAX.	UNITS
Collector to emitter voltage	V_{CES}		650	V
Continuous collector current	I_C	$T_C = 25\text{ }^\circ\text{C}$	247	A
		$T_C = 80\text{ }^\circ\text{C}$	185	
Pulsed collector current	I_{CM}	$T_C = 175\text{ }^\circ\text{C}$, $t_p = 6\text{ ms}$, $V_{GE} = 15\text{ V}$	660	
Peak switching current	I_{LM}		320	
Diode continuous forward current	I_F	$T_C = 25\text{ }^\circ\text{C}$	57	
		$T_C = 80\text{ }^\circ\text{C}$	43	
Maximum non-repetitive peak current	I_{FSM}	10 ms sine or 6 ms rectangular pulse, $T_J = 25\text{ }^\circ\text{C}$	270	
Gate to emitter voltage	V_{GE}		± 20	V
RMS isolation voltage	V_{ISOL}	Any terminal to case, $t = 1\text{ min}$	2500	
Maximum power dissipation (IGBT)	P_D	$T_C = 25\text{ }^\circ\text{C}$	517	W
		$T_C = 80\text{ }^\circ\text{C}$	328	
Maximum power dissipation (Diode)	P_D	$T_C = 25\text{ }^\circ\text{C}$	150	W
		$T_C = 80\text{ }^\circ\text{C}$	95	
Operating junction temperature range	T_J		-40 to +175	°C
Storage temperature range	T_{Stg}		-40 to +150	



ELECTRICAL SPECIFICATIONS ($T_J = 25\text{ }^\circ\text{C}$ unless otherwise specified)						
PARAMETER	SYMBOL	TEST CONDITIONS	MIN.	TYP.	MAX.	UNITS
Collector to emitter breakdown voltage	$V_{BR(CEs)}$	$V_{GE} = 0\text{ V}, I_C = 400\text{ }\mu\text{A}$	650	-	-	V
Collector to emitter voltage	$V_{CE(on)}$	$V_{GE} = 15\text{ V}, I_C = 100\text{ A}$	-	1.05	1.32	
		$V_{GE} = 15\text{ V}, I_C = 200\text{ A}$	-	1.24	-	
		$V_{GE} = 15\text{ V}, I_C = 100\text{ A}, T_J = 125\text{ }^\circ\text{C}$	-	1.02	-	
Gate threshold voltage	$V_{GE(th)}$	$V_{CE} = V_{GE}, I_C = 2\text{ mA}$	4.0	4.8	6.0	
Temperature coefficient of threshold voltage	$\Delta V_{GE(th)}/\Delta T_J$	$V_{CE} = V_{GE}, I_C = 2\text{ mA}, (25\text{ }^\circ\text{C to } 125\text{ }^\circ\text{C})$	-	-14	-	mV/ $^\circ\text{C}$
Forward transconductance	g_{fe}	$V_{CE} = 20\text{ V}, I_C = 100\text{ A}$	-	102	-	S
Transfer characteristics	V_{GE}	$V_{CE} = 20\text{ V}, I_C = 100\text{ A}$	-	6.4	-	V
Collector to emitter leakage current	I_{CES}	$V_{GE} = 0\text{ V}, V_{CE} = 650\text{ V}$	-	0.5	100	μA
		$V_{GE} = 0\text{ V}, V_{CE} = 650\text{ V}, T_J = 125\text{ }^\circ\text{C}$	-	0.2	-	
Diode forward voltage drop	V_{FM}	$I_C = 50\text{ A}, V_{GE} = 0\text{ V}$	-	2.0	2.9	V
		$I_C = 50\text{ A}, V_{GE} = 0\text{ V}, T_J = 125\text{ }^\circ\text{C}$	-	1.6	-	
Gate to emitter leakage current	I_{GES}	$V_{GE} = \pm 20\text{ V}$	-	-	± 240	nA

SWITCHING CHARACTERISTICS ($T_J = 25\text{ }^\circ\text{C}$ unless otherwise specified)						
PARAMETER	SYMBOL	TEST CONDITIONS	MIN.	TYP.	MAX.	UNITS
Total gate charge	Q_g	$I_C = 100\text{ A}, V_{CC} = 520\text{ V}, V_{GE} = 15\text{ V}$	-	894	-	nC
Gate to emitter charge	Q_{ge}		-	146	-	
Gate to collector charge	Q_{gc}		-	249	-	
Turn-on switching energy	E_{on}	$I_C = 100\text{ A}, V_{CC} = 325\text{ V}, V_{GE} = 15\text{ V}, L = 500\text{ }\mu\text{H}, R_g = 4.7\text{ }\Omega, T_J = 25\text{ }^\circ\text{C}$	-	0.4	-	mJ
Turn-off switching energy	E_{off}		-	4.5	-	
Total switching energy	E_{ts}		-	4.9	-	
Turn-on delay time	$t_{d(on)}$		ns	-	23	-
Rise time	t_r			-	24	-
Turn-off delay time	$t_{d(off)}$			-	367	-
Fall time	t_f	-		113	-	
Turn-on switching energy	E_{on}	$I_C = 100\text{ A}, V_{CC} = 325\text{ V}, V_{GE} = 15\text{ V}, L = 500\text{ }\mu\text{H}, R_g = 4.7\text{ }\Omega, T_J = 125\text{ }^\circ\text{C}$	-	0.5	-	mJ
Turn-off switching energy	E_{off}		-	6.5	-	
Total switching energy	E_{ts}		-	7	-	
Turn-on delay time	$t_{d(on)}$		ns	-	20	-
Rise time	t_r			-	25	-
Turn-off delay time	$t_{d(off)}$			-	420	-
Fall time	t_f	-		152	-	
Reverse bias safe operating area	RBSOA	$T_J = 175\text{ }^\circ\text{C}, I_C = 320\text{ A}, V_{CC} = 325\text{ V}, V_p = 650\text{ V}, R_g = 4.7\text{ }\Omega, V_{GE} = 15\text{ V to } 0\text{ V}, L = 500\text{ }\mu\text{H}$	Fullsquare			
Diode reverse recovery time	t_{rr}	$I_F = 50\text{ A}, dI_F/dt = 500\text{ A}/\mu\text{s}, V_{rr} = 200\text{ V}$	-	79	-	ns
Diode peak reverse current	I_{rr}		-	10.5	-	A
Diode recovery charge	Q_{rr}		-	409	-	nC
Diode reverse recovery time	t_{rr}	$I_F = 50\text{ A}, dI_F/dt = 500\text{ A}/\mu\text{s}, V_{rr} = 200\text{ V}, T_J = 125\text{ }^\circ\text{C}$	-	141	-	ns
Diode peak reverse current	I_{rr}		-	19	-	A
Diode recovery charge	Q_{rr}		-	1336	-	nC

THERMAL AND MECHANICAL SPECIFICATIONS						
PARAMETER	SYMBOL	MIN.	TYP.	MAX.	UNITS	
Operating junction temperature range	T_J	-40	-	175	$^\circ\text{C}$	
Storage temperature range	T_{Stg}	-40	-	150		
Junction to case	per switch R_{thJC} per diode	-	-	0.29	$^\circ\text{C}/\text{W}$	
		-	-	1.00		
Case to sink per module	R_{thCS}	-	0.1	-		
Mounting torque	case to heatsink	-	-	4	Nm	
	case to terminal 1, 2, 3	-	-	3		
Weight		-	185	-	g	

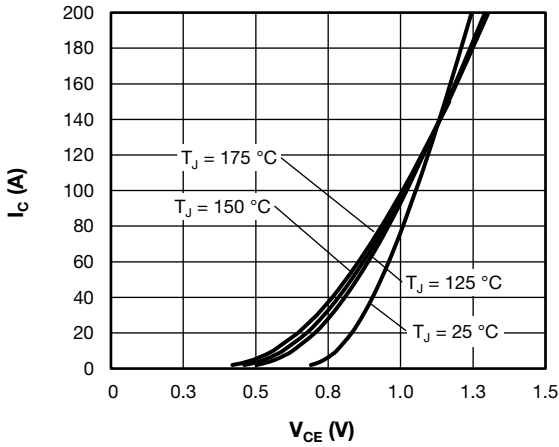

Fig. 1 - Typical Trench IGBT Output Characteristics, $V_{GE} = 15\text{ V}$

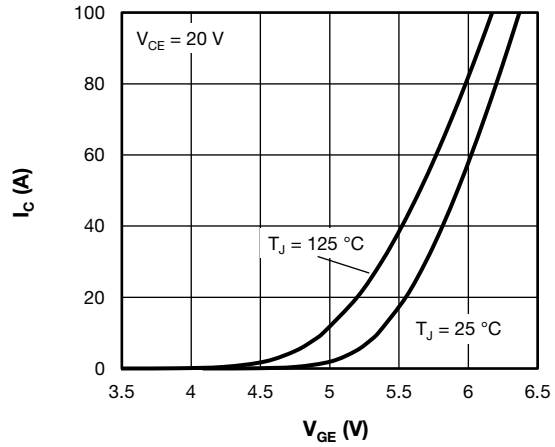

Fig. 4 - Typical Trench IGBT Transfer Characteristics

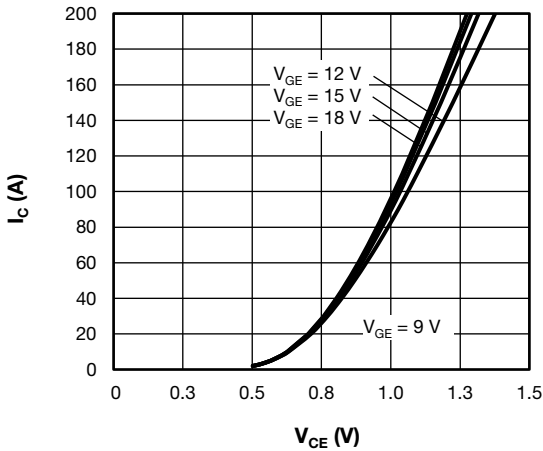

Fig. 2 - Typical Trench IGBT Output Characteristics, $T_J = 125\text{ °C}$

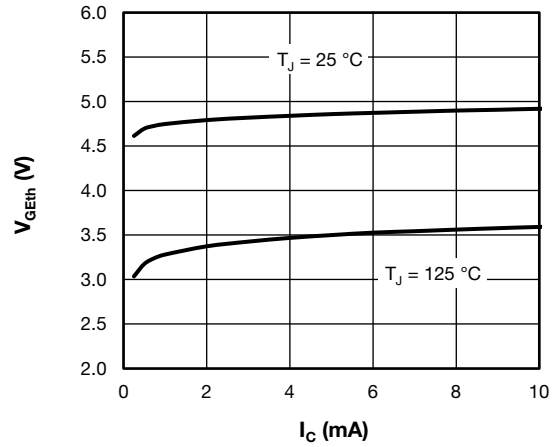

Fig. 5 - Typical Trench IGBT Gate Threshold Voltage

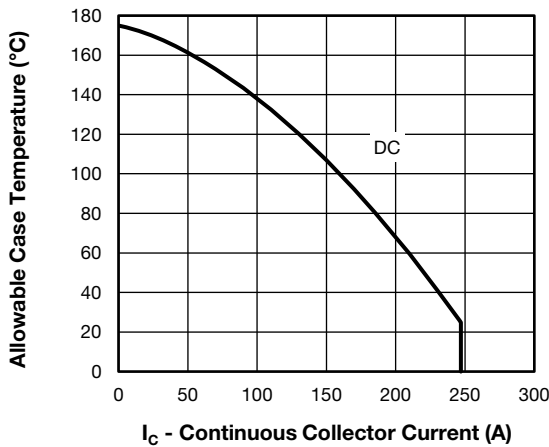

Fig. 3 - Maximum Trench IGBT Continuous Collector Current vs. Case Temperature

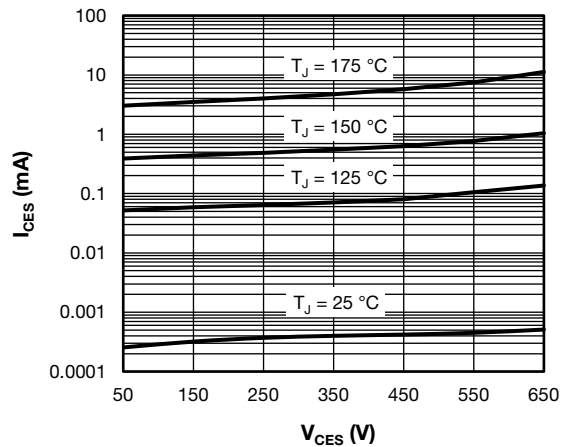

Fig. 6 - Typical Trench IGBT Zero Gate Voltage Collector Current

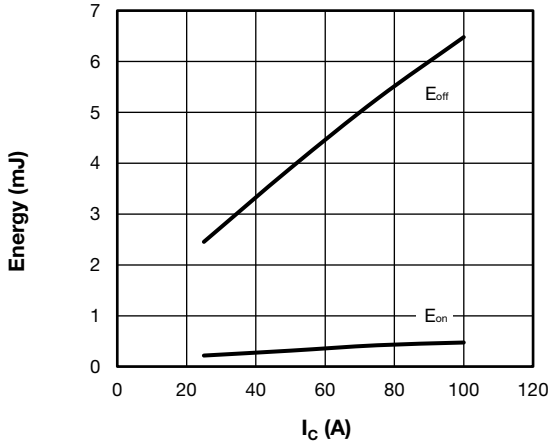

Fig. 7 - Typical Trench IGBT Energy Loss vs. I_C (with Antiparallel Diode)

$T_J = 125\text{ }^\circ\text{C}$, $V_{CC} = 325\text{ V}$, $R_g = 4.7\text{ }\Omega$, $V_{GE} = +15\text{ V}/-15\text{ V}$, $L = 500\text{ }\mu\text{H}$

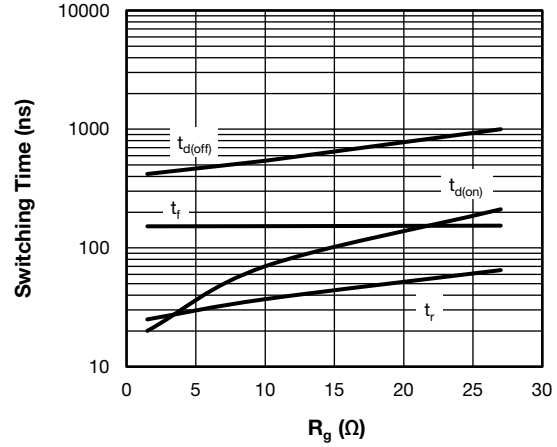

Fig. 10 - Typical Trench IGBT Switching Time vs. R_g (with Antiparallel Diode)

$T_J = 125\text{ }^\circ\text{C}$, $V_{CC} = 325\text{ V}$, $I_C = 100\text{ A}$, $V_{GE} = +15\text{ V}/-15\text{ V}$, $L = 500\text{ }\mu\text{H}$

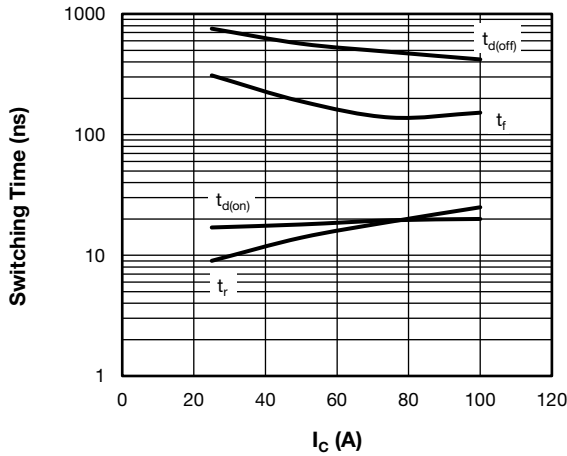

Fig. 8 - Typical Trench IGBT Switching Time vs. I_C (with Antiparallel Diode)

$T_J = 125\text{ }^\circ\text{C}$, $V_{CC} = 325\text{ V}$, $R_g = 4.7\text{ }\Omega$, $V_{GE} = +15\text{ V}/-15\text{ V}$, $L = 500\text{ }\mu\text{H}$

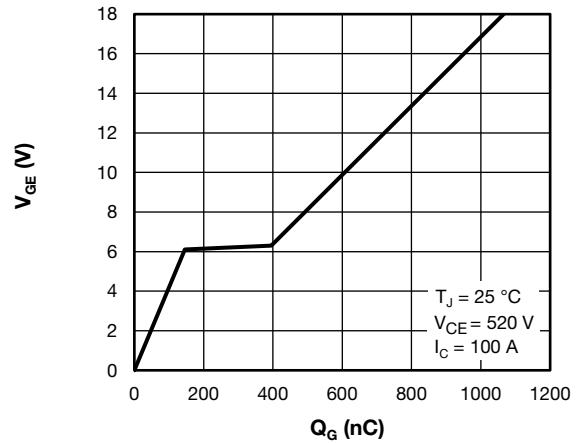

Fig. 11 - Typical Trench IGBT Gate Charge vs. Gate to Collector Voltage

$T_J = 25\text{ }^\circ\text{C}$
 $V_{CE} = 520\text{ V}$
 $I_C = 100\text{ A}$

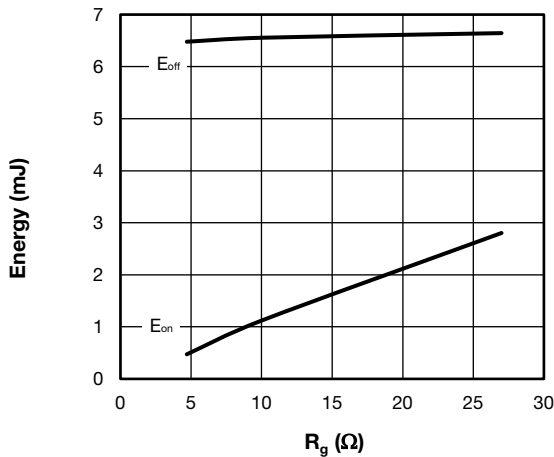

Fig. 9 - Typical Trench IGBT Energy Loss vs. R_g (with Antiparallel Diode)

$T_J = 125\text{ }^\circ\text{C}$, $V_{CC} = 325\text{ V}$, $I_C = 100\text{ A}$, $V_{GE} = +15\text{ V}/-15\text{ V}$, $L = 500\text{ }\mu\text{H}$

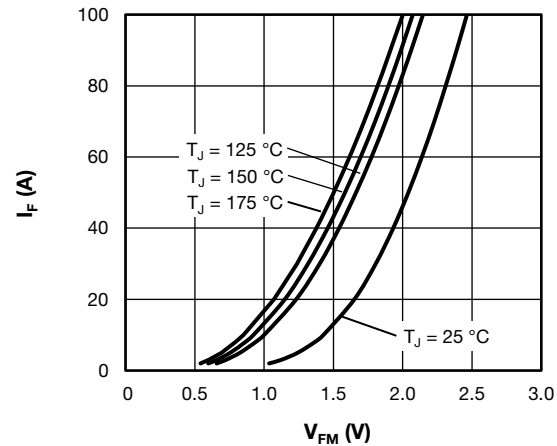

Fig. 12 - Typical Antiparallel Diode Forward Characteristics

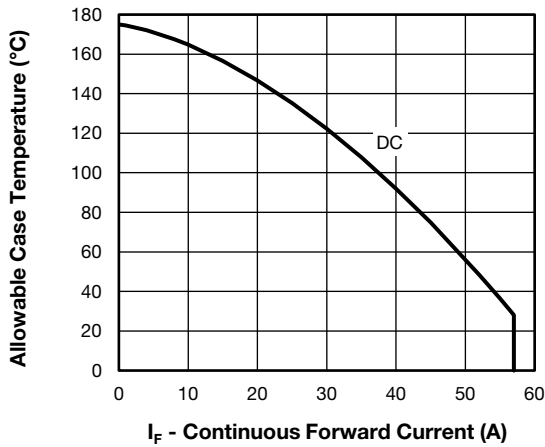

Fig. 13 - Maximum Antiparallel Diode Continuous Forward Current vs. Case Temperature

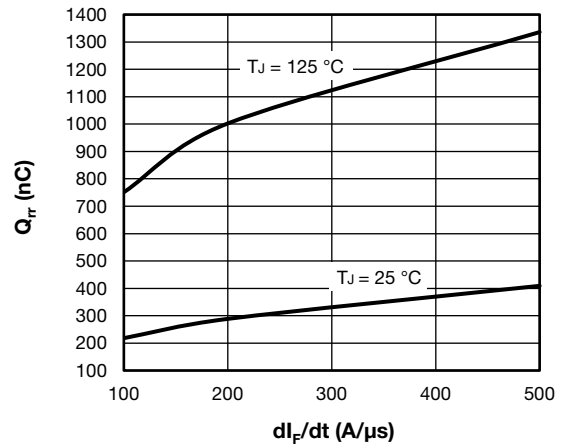

Fig. 16 - Typical Antiparallel Diode Reverse Recovery Charge vs. dI_F/dt
 $I_F = 50 \text{ A}, V_{CC} = 200 \text{ V}$

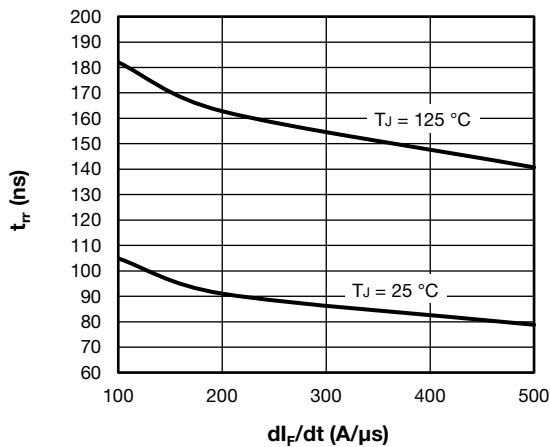

Fig. 14 - Typical Antiparallel Diode Reverse Recovery Time vs. dI_F/dt
 $I_F = 50 \text{ A}, V_{CC} = 200 \text{ V}$

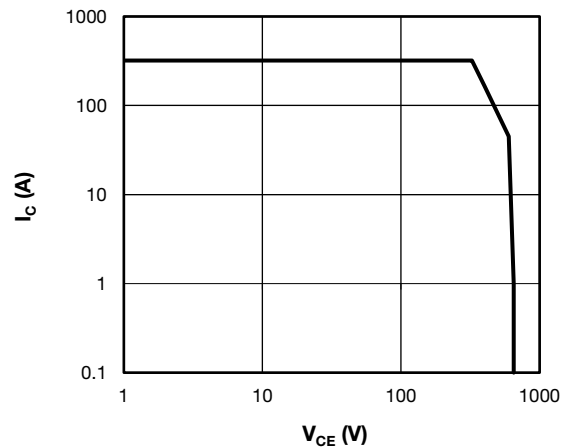

Fig. 17 - Trench IGBT Reverse BIAS SOA
 $T_J = 175 \text{ °C}, V_{GE} = 15 \text{ V}$

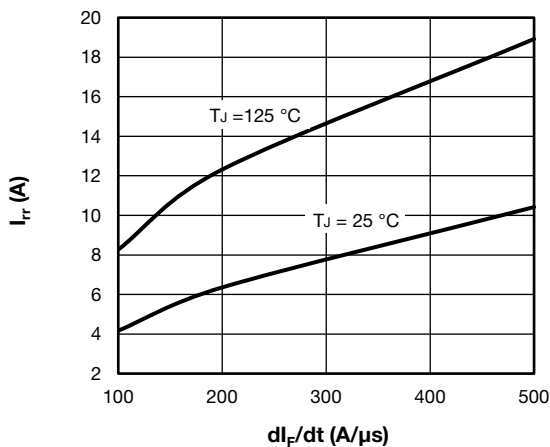

Fig. 15 - Typical Antiparallel Diode Reverse Recovery Current vs. dI_F/dt
 $I_F = 50 \text{ A}, V_{CC} = 200 \text{ V}$

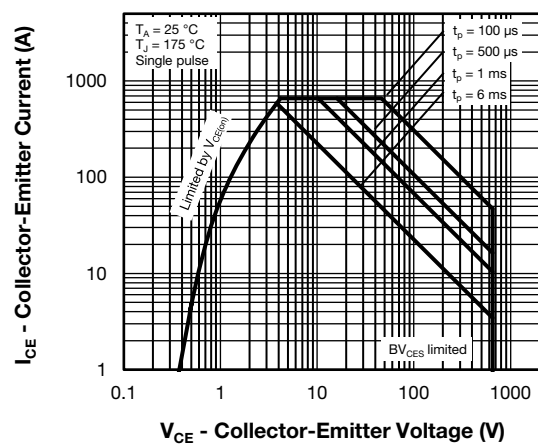

Fig. 18 - Trench IGBT Safe Operating Area

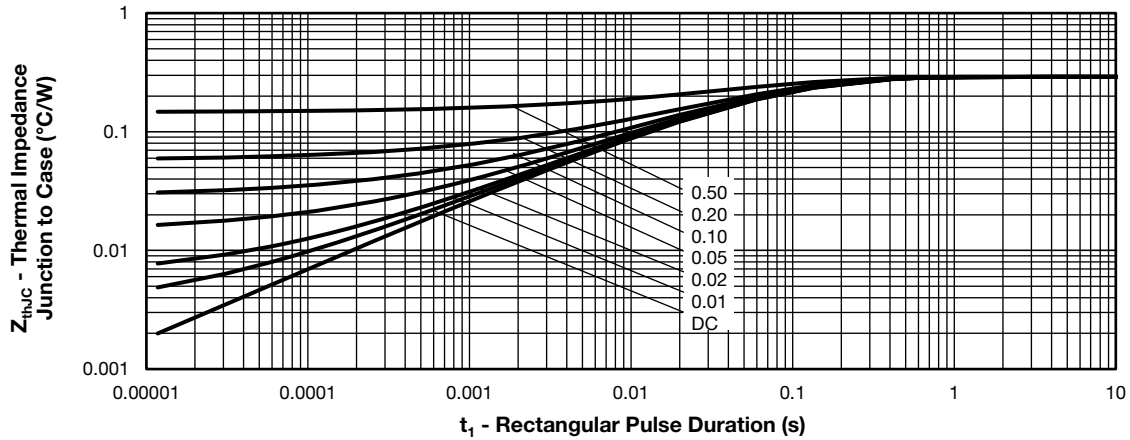

Fig. 19 - Maximum Trench IGBT Thermal Impedance Z_{thJC} Characteristics

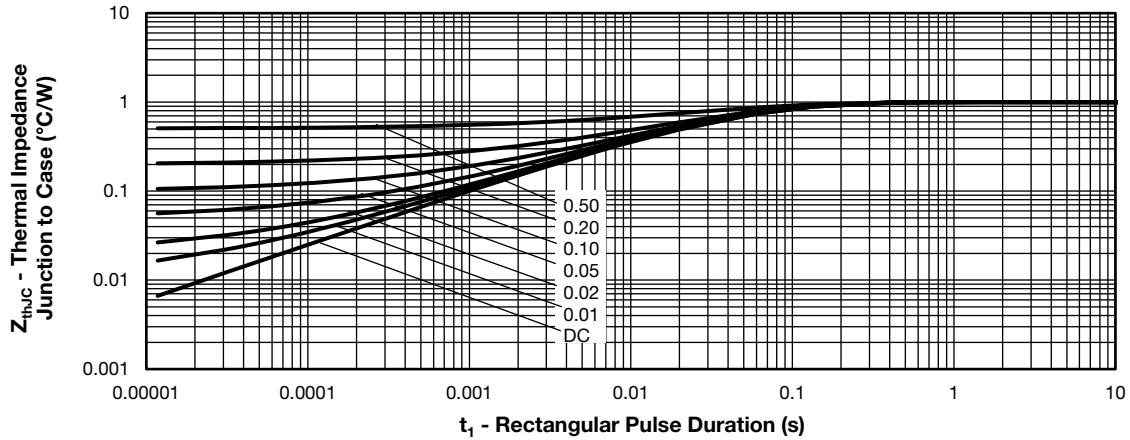

Fig. 20 - Maximum Antiparallel Diode Thermal Impedance Z_{thJC} Characteristics

ORDERING INFORMATION TABLE

Device code	VS-	GT	100	T	S	065	S
	①	②	③	④	⑤	⑥	⑦

- ① - Vishay Semiconductors product
- ② - IGBT die technology (GT = trench)
- ③ - Current rating (100 = 100 A)
- ④ - Circuit configuration (T = half bridge)
- ⑤ - Package indicator (S = INT-A-PAK)
- ⑥ - Voltage code (065 = 650 V)
- ⑦ - Speed/type (S = standard speed IGBT)



CIRCUIT CONFIGURATION

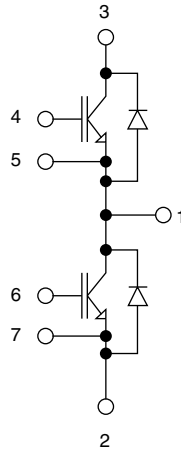

LINKS TO RELATED DOCUMENTS	
Dimensions	www.vishay.com/doc?95173



DIMENSIONS in millimeters (inches)

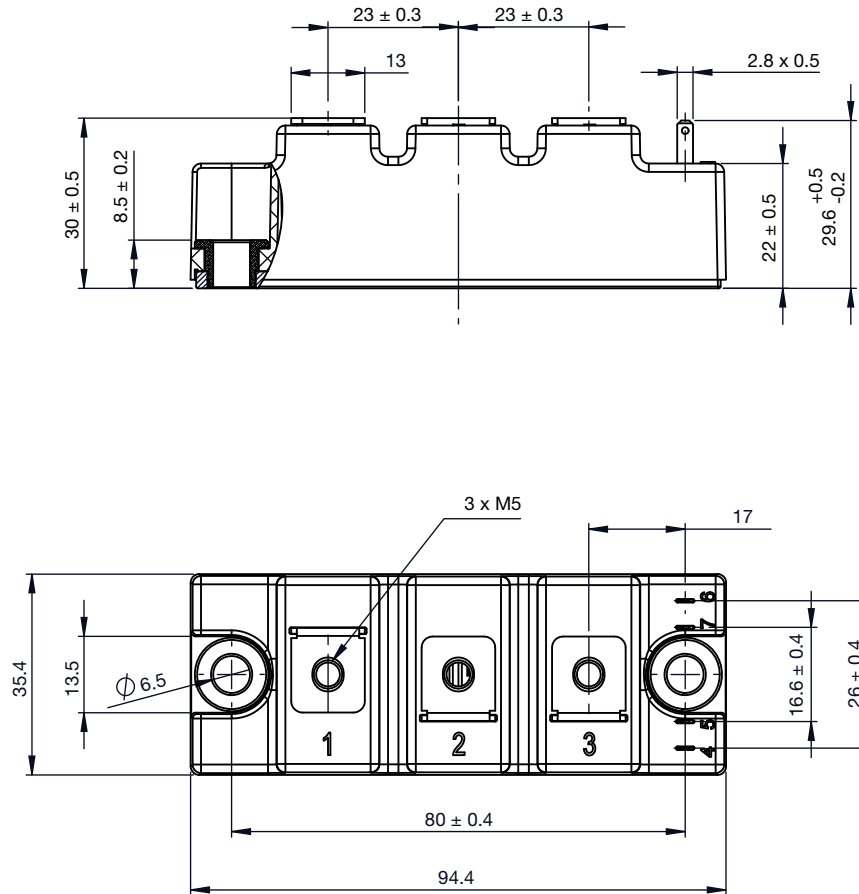

General tolerance ± 0.5 mm



Disclaimer

ALL PRODUCT, PRODUCT SPECIFICATIONS AND DATA ARE SUBJECT TO CHANGE WITHOUT NOTICE TO IMPROVE RELIABILITY, FUNCTION OR DESIGN OR OTHERWISE.

Vishay Intertechnology, Inc., its affiliates, agents, and employees, and all persons acting on its or their behalf (collectively, "Vishay"), disclaim any and all liability for any errors, inaccuracies or incompleteness contained in any datasheet or in any other disclosure relating to any product.

Vishay makes no warranty, representation or guarantee regarding the suitability of the products for any particular purpose or the continuing production of any product. To the maximum extent permitted by applicable law, Vishay disclaims (i) any and all liability arising out of the application or use of any product, (ii) any and all liability, including without limitation special, consequential or incidental damages, and (iii) any and all implied warranties, including warranties of fitness for particular purpose, non-infringement and merchantability.

Statements regarding the suitability of products for certain types of applications are based on Vishay's knowledge of typical requirements that are often placed on Vishay products in generic applications. Such statements are not binding statements about the suitability of products for a particular application. It is the customer's responsibility to validate that a particular product with the properties described in the product specification is suitable for use in a particular application. Parameters provided in datasheets and / or specifications may vary in different applications and performance may vary over time. All operating parameters, including typical parameters, must be validated for each customer application by the customer's technical experts. Product specifications do not expand or otherwise modify Vishay's terms and conditions of purchase, including but not limited to the warranty expressed therein.

Hyperlinks included in this datasheet may direct users to third-party websites. These links are provided as a convenience and for informational purposes only. Inclusion of these hyperlinks does not constitute an endorsement or an approval by Vishay of any of the products, services or opinions of the corporation, organization or individual associated with the third-party website. Vishay disclaims any and all liability and bears no responsibility for the accuracy, legality or content of the third-party website or for that of subsequent links.

Except as expressly indicated in writing, Vishay products are not designed for use in medical, life-saving, or life-sustaining applications or for any other application in which the failure of the Vishay product could result in personal injury or death. Customers using or selling Vishay products not expressly indicated for use in such applications do so at their own risk. Please contact authorized Vishay personnel to obtain written terms and conditions regarding products designed for such applications.

No license, express or implied, by estoppel or otherwise, to any intellectual property rights is granted by this document or by any conduct of Vishay. Product names and markings noted herein may be trademarks of their respective owners.